

AvaSpire®



SOLVAY

asking more from chemistry®

AvaSpire® PAEK

Design & Processing Guide

**SPECIALTY
POLYMERS**

Table of Contents

Introduction and Typical Properties	5	Long-Term Mechanical Properties	34
AV-600 Series5	Creep Properties	34
AV-700 Series5	Creep34
AV-800 Series6	Isochronous curves34
AvaSpire® PAEK Grades	6	Apparent or Creep Modulus Graphs35
Property Data	6	Fatigue Properties	38
Agency Approvals	16	Design Considerations38
Food Contact	16	Fatigue Testing38
ISO 10993	16	Testing AvaSpire® PAEK39
Underwriters Laboratories	16	Tensile fatigue of AvaSpire® PAEK	
ASTM International	16	at 23 °C (73 °F)39
Short-Term Mechanical Properties	17	Tensile fatigue of glass fiber reinforced AvaSpire®	
Poisson's Ratio	17	PAEK at 160 °C (320 °F)39
Tensile Properties	17	Temperature Effects	40
Fibrous Reinforcement19	Thermal Properties	40
Temperature19	Linear Thermal Expansion40
Stress/Strain Curves20	Definition40
Flexural Properties	26	Measurement41
Test Methods for Flexural Properties26	CLTE Results42
Effect of Temperature27	Design Implications42
Compressive Properties	28	Comparing CLTE Values	
Compressive Strength Testing28	from Different Sources43
Stress-strain curves28	Test method43
Compressive Modulus Testing29	Part thickness43
Shear Properties	30	Temperature range and phase changes43
Shear Strength Test Method30	Processing parameters43
Shear Strength Values30	Reinforcements43
Impact Properties	31	Deflection Temperature Under Load (HDT)43
Notched Izod31	Glass Transition Temperature (T_g)44
Unnotched Izod32	Melting Temperature (T_m)44
Falling Weight Impact Tests	32	Thermal Conductivity45
Instrumented Impact Testing33	Specific Heat45
		Thermal Stability	46
		Heat Aging46
		Test Procedures46
		Results46
		Thermogravimetric Analysis (TGA)49
		Combustion Properties	51
		Glow Wire Testing51
		Vertical Flammability per UL 9451
		Horizontal burning test52
		50 W (20 mm) Vertical burn test52
		500 W (125 mm) Vertical burning test52
		Oxygen Index53
		Commercial Aircraft Tests53
		Vertical burn53
		Smoke density54
		Toxic gas emissions54
		Heat release rate (OSU)54

Electrical Properties	56	Design Principles	74
Dielectric Breakdown Voltage and Strength56	Mechanical Design	75
Volume Resistivity56	Using Classical Stress-Strain Equations75
Surface Resistivity57	Limitations of Design Calculations78
Dielectric Constant57	Deflection Calculations78
Dissipation Factor57	Stress Calculations78
UL 746A Short-Term Properties	58	Reinforcing Fiber Orientation Considerations79
High-voltage, low-current, dry arc resistance – ASTM		Designing for Equivalent Part Stiffness80
D49558	Changing section thickness80
High-Current Arc Ignition (HAI)59	Adding ribs to maintain stiffness80
High-voltage arc resistance to ignition59	Designing for Sustained Load81
		Considering Stress Concentrations81
Environmental and Chemical Resistance	60	Computer Aided Engineering (CAE)	82
Chemical Resistance	60	Injection Molding Simulation82
Stress Testing60	Finite Element Analysis (FEA)82
Transportation Fluid Resistance	62	Coupling the Injection Molding and	
Aircraft Fluids62	Mechanical Simulations83
Skydrol® LD-4 hydraulic fluid62	Designing for Assembly	83
Jet Fuel A/A-1 (ASTM D1655)62	Interference or Press Fits83
Automotive Fluids63	Calculating the Allowable Interference83
Automatic transmission fluid63	Mechanical Fasteners84
Automotive brake fluid64	Self-tapping screws84
Biodiesel fuel64	Improving torque retention85
Motor oil65	Tightening torque85
Oil and Gas Fluids Resistance	65	Pull-out force calculation85
Test Procedure65	Threaded inserts85
Results66	Molded-in threads86
Conclusions66	Designing with Snap Fits86
Sterilization Resistance	69	Tapered Cantilever Beam Equation87
Gamma Radiation69	Designing for Injection Molding	88
Test procedures69	Wall Thickness88
Electron Beam69	Wall Thickness Variation88
Test procedures69	Draft Angle88
Ethylene Oxide69	Ribs88
Test procedures70	Coring89
Low-Temperature Hydrogen Peroxide		Bosses89
Sterilization70	Processing	90
Test procedures70	Rheological Properties	90
Steam Autoclaving70	Injection Molding	94
Weathering	71	Equipment for Injection Molding94
Test Method71	Injection molding machine94
Results71	Clamping pressure94
Appearance and color71	Screw design94
Mechanical properties72	Nozzle94
Conclusions73	Tooling95
Water Absorption	73	Tool steel95
		Tool types95
		Cavity Layout95
		Side action96
		Sprue and runner systems96
		Hot runner systems96
		Mold Shrinkage96

Gating97
Gate types97
Gate location97
Gate size98
Venting98
Draft98
Ejector systems99
Thermal Management99
Drying99
Injection Molding Process99
Process Setup	100
Process control	100
Starting Point Molding Conditions	101
Start-Up, Shut-Down and Purging	102
Shut-Down Procedure	102
Purging	102
Annealing	102
Regrind	102
Extrusion	104
Extrusion Materials	104
Equipment for Extrusion	104
Dryer	104
Feeder	104
Extruder	104
Adapter and die	104
Take Off Equipment	104
Starting Point Process Conditions	105
Drying	105
Temperature Setup	105
Shut-Down	105
Purging	105
Sheet and Film Extrusion	105
Tube Extrusion	106
Profile Extrusion	106
Filament	107
Fine Fiber	107
Wire and Cable Extrusion	110
Equipment for Wire and Cable Extrusion	110
Extruder	110
Die and crosshead design	110
Draw down ratio	111
Downstream equipment	111
Processing	111
Drying	111
Temperature setup	111
Purging	111
.	112

Secondary Operations 113

Joining	113
Welding	113
Spin welding	113
Vibration welding	113
Ultrasonic welding	114
Adhesive Bonding	115
Surface preparation	115
Selection of adhesive	116

Painting and Marking 116

Vacuum Metallization and Plating 116

Crystallinity and Annealing	116
Crystalline Structure Formation	116
Measurement of Crystallinity	117
Crystallinity Affects Properties	117
Annealing Fabricated Articles	118
Annealing Procedure	118

Machining Guidelines 119

Introduction	119
General Guidelines	119
Tooling	119
Coolants	119
Chucking and part support	119
Pre-cut and finish machining	119
Fiber Orientation in Extruded Shapes	119
Stress relieving or annealing	119
Machining Parameters	120
Drilling	120
Milling	120
Troubleshooting	121

Index 123

Introduction and Typical Properties

AvaSpire® polyaryletherketone (PAEK) is a family of proprietary polymers that make up a versatile group of tailor-made formulations designed to meet specific application requirements, with some grades offering more attractive economics.

The AvaSpire® PAEK family consists of three polymer chemistries, each with distinct properties. Figure 1.1 below shows the basic building blocks used to create the various polymers, which offer a variety of performance properties.

Figure 1.1 Basic building blocks

Aryl linkages provide high modulus, thermal stability, and flame retardancy.

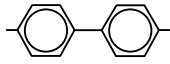

Ether linkages provide toughness, ductility and ease of processing.

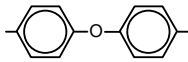

Ketones provide long-term thermal oxidative resistance.

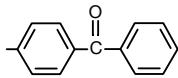

AV-600 Series

Products in the AV-600 series deliver improved ductility and higher flexural and torsional modulus between 150 °C (300 °F) and 190 °C (375 °F) than comparable PEEK grades. They have lower crystallinity than PEEK, which gives them better dimensional stability and lower warpage. The light color of the resin provides good part aesthetics and excellent colorability.

- Higher ductility and toughness than comparable PEEK grades
- Higher stiffness in the temperature range 150 °C to 190 °C (300 °F to 375 °F) than comparable PEEK grades
- Lower crystallinity than PEEK for better dimensional stability and lower warpage
- Light color resin for good part aesthetics
- Excellent colorability

AV-700 Series

Products in the AvaSpire® AV-700 series fill the cost/performance gap between ultra-performance crystalline polymers like PEEK and high-performance crystalline polymers like liquid crystal polymers (LCP), polyphenylene sulfide (PPS), and polyphthalamide (PPA).

- Higher modulus than PEEK
- Lower moisture absorption than PPA
- Equivalent or better chemical resistance than PEEK
- Higher thermal capabilities than PPS and PPA
- Better ductility than PPS
- Low friction and excellent wear resistance in dry and lubricated environments
- Up to 30 % cost reduction compared to PEEK

AV-800 Series

The AvaSpire® 800 series products offer better retention of mechanical properties than PEEK at high temperatures.

- Higher stiffness than comparable PEEK grades at a temperature range of 150 °C to 240 °C (300 °F to 465 °F)
- Lower crystallinity than PEEK leading to reduced warpage and improved dimensional stability
- Superior processing characteristics over PEK and PEKKEK*

*polyetherketone (PEK), polyetherketoneetherketone (PEKKEK)

AvaSpire® PAEK Grades

AvaSpire® PAEK is available in a variety of grades suited for a wide range of applications and processing techniques.

Table 1.1 AV-600 series grades

Unreinforced Grades	
AV-621 NT	Low flow extrusion version of AV-651
AV-630 NT	Wire and cable, monofilament, and ultra-thin film extrusion
AV-651 BG15	Better ductility, more cost-effective than PEEK
Reinforced Grades	
AV-621 GF30 BG20	AV-621 with 30 % glass fiber
AV-621 CF30	AV-621 with 30 % carbon fiber
AV-651 GF30 BG20	AV-651 with 30 % glass fiber
AV-651 CF30	AV-651 with 30 % carbon fiber

Table 1.2 AV-700 series grades

Unreinforced Grades	
AV-722 BG20	Low melt flow, basis for most AV-700 formulations – extrusion and injection molding
Reinforced Grades	
AV-750 GF40 NT	High stiffness, cost effective, 40 % glass fiber
AV-722 CF30	AV-722 with 30 % carbon fiber
Wear Resistant Grades	
AV-722 SL30	Low melt flow, dry and lubricated – extrusion, injection molding
AV-742 SL30	High melt flow, dry and lubricated – injection molding
AV-755 SL45	High load bearing, lubricated – injection molding

Table 1.3 AV-800 series grades

Unreinforced Grades	
AV-848 NT	Higher thermal performance than PEEK – extrusion, injection molding
Reinforced Grades	
AV-848 GF30 NT	AV-848 with 30 % glass fiber
AV-848 CF30	AV-848 with 30 % carbon fiber

Property Data

Typical properties in SI units can be found in Tables 1.4 to 1.7 and in US units in Tables 1.8 to 1.11. These tables include a collection of physical, mechanical, thermal and flammability properties. Electrical properties can be found in Tables 1.12 and 1.13. Typical property data is generated by preparing standard specimens and conducting tests in a carefully controlled environment.

The properties of a material are of fundamental importance in component design. The designer must match the requirements of the application to the properties of the material to achieve an optimal part design. Properties measured in standard controlled environments will not be identical to those observed in a finished part, but they allow prediction of end-use performance and allow for comparison between materials.

Finished components will likely contain features, such as weld lines, corners, or other aspects that will reduce the strength of the component. The strength can also be locally altered by fiber orientation, relative degree of crystallinity, and thermal history (annealing). Therefore, verifying the suitability of a material for an article by prototype testing is recommended.

In the case of polymeric materials, the mechanical properties in particular are more time and temperature dependent than those of metals, and in some ways, they are more affected by environmental factors. To design successfully with polymeric materials, the designer must consider not only the short-term mechanical properties, but also the time, temperature, and environmental demands of each application.

Table 1.4 Typical properties⁽¹⁾ of AvaSpire® PAEK unreinforced resins (SI units)

Property		Units	AV-621 NT	AV-630 NT	AV-651 BG15	AV-722 BG20	AV-848 NT ⁽²⁾	Test Method
Mechanical								
Tensile strength	50 mm/min	MPa	84	92	87	89	94	ASTM D638
	50 mm/min	MPa	87	89	89	91		ISO 527-2/1A
Tensile modulus	50 mm/min	GPa	2.9	3.3	3.0	3.7	3.1	ASTM D638
	1 mm/min	GPa	3.1	3.4	3.2	3.9		ISO 527-2/1A
Tensile elongation at yield	50 mm/min	%	6.0	6.0	6.2	5.0	6.7	ASTM D638
	50 mm/min	%	5.7	5.4	5.7	4.5		ISO 527-2/1A
Tensile elongation at break	50 mm/min	%	> 40	50 – 80	> 40	25	35	ASTM D638
	50 mm/min	%	> 40	50 – 80	> 40	25		ISO 527-2/1A
Flexural strength		MPa	122	127	124	141	134	ASTM D790
		MPa	106	128	127	138		ISO 178
Flexural modulus		GPa	3.1	3.2	3.1	3.7	3.3	ASTM D790
		GPa	3.0	3.3	3.2	3.8		ISO 178
Compressive strength		MPa	111	110	112	112	118	ASTM D695
Izod impact, notched		J/m	100	91	69	80	75	ASTM D256
		kJ/m ²	7.6	7.0	6.6	7.0		ISO 180
Izod impact, unnotched		J/m	NB ⁽³⁾	NB ⁽³⁾	NB ⁽³⁾	NB ⁽³⁾	NB ⁽³⁾	ASTM D4812
		kJ/m ²	NB ⁽³⁾	NB ⁽³⁾	NB ⁽³⁾	NB ⁽³⁾		ISO 180
Shear strength		MPa	81	79	78	79	82	ASTM D732
Poisson's ratio			0.39		0.42	0.43		ASTM D638
Thermal								
Heat deflection temperature ⁽⁴⁾	1.82 MPa	°C	187	181	190	161	252	ASTM D648
Glass transition temperature		°C	158	158	158	150	158	ASTM D3418
Melting point		°C	340	340	345	340 ⁽⁵⁾	340	ASTM D3418
CLTE, flow direction	- 50 °C to 50 °C	ppm/°C	47		47	45		ASTM E831
Thermal conductivity		W/m-K	0.20	0.23	0.24	0.22	0.22	ASTM E1530
Specific heat capacity	200 °C	kJ/kg-°C	2.00	1.96	1.82	1.97	1.66	DSC
Flammability	1.6 mm		V-0		V-0			UL 94
	0.8 mm		V-0		V-0			UL 94
Oxygen index		%	34	38		40		ASTM D2863
General								
Specific gravity			1.29	1.30	1.29	1.32	1.32	ASTM D792
Water absorption	24 hours	%	0.2	0.2	0.2	0.1	0.5	ASTM D570
Rockwell hardness	M scale		93	92	94	95		ASTM D785
Melt flow	400 °C, 2.16 kg	g/10 min	5	7	25	1		ASTM D1238
Melt viscosity	400 °C, 1000 s ⁻¹	kPa-s	0.41		0.24	0.45	0.50	ASTM D3835
Mold shrinkage, as molded flow direction	3.2 × 12.7 × 127 mm	%	0.7 – 0.9		0.7 – 0.9	0.8 – 1.0		ASTM D955
Mold shrinkage, as molded transverse direction	3.2 × 12.7 × 127 mm	%	1.1 – 1.3		1.0 – 1.2	1.2 – 1.4		ASTM D955

⁽¹⁾ Actual properties of individual batches will vary within specification limits

⁽²⁾ Values are based on limited production

⁽³⁾ NB = no break

⁽⁴⁾ Measured on 3.2-mm thick specimens annealed for 2 hours at 200 °C

⁽⁵⁾ Melting point of major component

Table 1.5 Typical properties⁽¹⁾ of AvaSpire® PAEK glass fiber reinforced resins (SI units)

Property		Units	AV-621	AV-651	AV-750	AV-848	Test Method
			GF30 BG20	GF30 BG20	GF40 NT	GF30 NT ⁽²⁾	
Mechanical							
Tensile strength	5 mm/min	MPa	147	156	191	168	ASTM D638
	5 mm/min	MPa	158	162	188		ISO 527-2/1A
Tensile modulus	5 mm/min	GPa	9.9	9.9	15.1	10.6	ASTM D638
	1 mm/min	GPa	10.6	10.4	16.7		ISO 527-2/1A
Tensile elongation at break	5 mm/min	%	3.2	2.9	1.8	2.3	ASTM D638
	5 mm/min	%	3.2	2.9	1.8		ISO 527-2/1A
Flexural strength		MPa	237	234	253	239	ASTM D790
		MPa	236	228	250		ISO 178
Flexural modulus		GPa	9.4	9.4	14.8	9.9	ASTM D790
		GPa	9.8	9.7	15.4		ISO 178
Compressive strength		MPa	159	168	182	139	ASTM D695
Izod impact, notched		J/m	123	107	53	69	ASTM D256
		kJ/m ²	14.3	11.5	8.5		ISO 180
Izod impact, unnotched		J/m	1,040	960	590	960	ASTM D4812
		kJ/m ²	70	64	41		ISO 180
Shear strength		MPa	85	83	89	85	ASTM D732
Poisson's ratio			0.43				ASTM D638
Thermal							
Heat deflection temperature ⁽³⁾	1.82 MPa	°C	217	213	285	257	ASTM D648
Glass transition temperature		°C	158	158	150	158	ASTM D3418
Melting point		°C	340	345	345	340	ASTM D3418
CLTE, flow direction	- 50 °C to 50 °C	ppm/°C	17	17	15		ASTM E831
Thermal conductivity		W/m-K	0.28	0.30	0.31	0.29	ASTM E1530
Specific heat capacity	200 °C	kJ/kg-°C	1.66	1.65	1.62	1.71	DSC
Flammability	1.6 mm		V-0	V-0	V-0		UL 94
	0.8 mm		V-1	V-1	V-1		UL 94
General							
Specific gravity			1.55	1.52	1.65	1.53	ASTM D792
Water absorption	24 hours	%	0.2	0.2	0.1	0.1	ASTM D570
Rockwell hardness	M scale		101	101	105		ASTM D785
Melt flow	400 °C, 2.16 kg	g/10 min	2	9	7 ⁽⁴⁾	9	ASTM D1238
Melt viscosity	400 °C, 1000 s ⁻¹	kPa-s	0.65	0.41	0.45	0.60	ASTM D3835
Mold shrinkage, as molded flow direction	3.2 × 12.7 × 127 mm	%	0.1 – 0.3	0.2 – 0.4	0.1 – 0.3	0.2 – 0.4	ASTM D955
Mold shrinkage, as molded transverse direction	3.2 × 12.7 × 127 mm	%	0.9 – 1.1	1.3 – 1.5	1.2 – 1.4	0.5 – 0.7	ASTM D955

⁽¹⁾ Actual properties of individual batches will vary within specification limits

⁽²⁾ Values are based on limited production

⁽³⁾ Measured on 3.2-mm thick specimens annealed for 2 hours at 200 °C

⁽⁴⁾ Conditions are 380 °C, 2.16 Kg

Table 1.6 Typical properties⁽¹⁾ of AvaSpire® PAEK carbon fiber reinforced resins (SI units)

Property		Units	AV-621 CF30	AV-651 CF30	AV-722 CF30	AV-848 CF30 ⁽²⁾	Test Method
Mechanical							
Tensile strength	5 mm/min	MPa	181	184	200	176	ASTM D638
	5 mm/min	MPa	196	192	224		ISO 527-2/1A
Tensile modulus	5 mm/min	GPa	17.2	20.7	22.0	18.8	ASTM D638
	1 mm/min	GPa	23.3	21.1	26.6		ISO 527-2/1A
Tensile elongation at break	5 mm/min	%	2.2	1.5	1.5	1.5	ASTM D638
	5 mm/min	%	2.2	1.5	1.5		ISO 527-2/1A
Flexural strength		MPa	277	262	304	259	ASTM D790
		MPa	296	280	334		ISO 178
Flexural modulus		GPa	15.1	17.2	19.3	16.5	ASTM D790
		GPa	21.3	19.1	25.0		ISO 178
Compressive strength		MPa	152	168	170	145	ASTM D695
Izod impact, notched		J/m	69	59	53	43	ASTM D256
		kJ/m ²	9.6	8.4	8.5		ISO 180
Izod impact, unnotched		J/m	640	590	530	530	ASTM D4812
		kJ/m ²	39	37	39		ISO 180
Shear strength		MPa	91	94	98	95	ASTM D732
Poisson's ratio					0.44		ASTM D638
Thermal							
Heat deflection temperature ⁽³⁾	1.82 MPa	°C	210	212	276	257	ASTM D648
Glass transition temperature.		°C	160	158	150	158	ASTM D3418
Melting point		°C	340	345	340 ⁽⁴⁾	340	ASTM D3418
CLTE, flow direction	- 50 °C to 50 °C	ppm/°C	5.0	8.2	6.0		ASTM E831
Thermal conductivity		W/m-K	0.35	0.36	0.34	0.37	ASTM E1530
Specific heat capacity	200 °C	kJ/kg-°C	1.81	1.77	1.74		DSC
General							
Specific gravity			1.42	1.42	1.42	1.42	ASTM D792
Water absorption	24 hours	%	0.1	0.2	0.1	0.1	ASTM D570
Rockwell hardness	M scale		101	104	107		ASTM D785
Melt flow	400 °C, 2.16 kg	g/10 min	1.0	4.5	0.8	3.5	ASTM D1238
Melt viscosity	400 °C, 1000 s ⁻¹	kPa-s	0.79	0.54	0.47	0.52	ASTM D3835
Mold shrinkage, as molded flow direction	3.2 × 12.7 × 127 mm	%	0.0 – 0.2	0.0 – 0.2	0.0 – 0.2	0.0 – 0.2	ASTM D955
Mold shrinkage, as molded transverse direction	3.2 × 12.7 × 127 mm	%	0.9 – 1.1	0.9 – 1.1	1.4 – 1.6	0.4 – 0.6	ASTM D955

⁽¹⁾ Actual properties of individual batches will vary within specification limits

⁽²⁾ Values are based on limited production

⁽³⁾ Measured on 3.2-mm thick specimens annealed for 2 hours at 200 °C

⁽⁴⁾ Melting point of major component

Table 1.7 Typical properties⁽¹⁾ of AvaSpire® PAEK wear resistant resins (SI units)

Property		Units	AV-722 SL30	AV-742 SL30	AV-755 SL45	Test Method
Mechanical						
Tensile strength	5 mm/min	MPa	136	143	169	ASTM D638
	5 mm/min	MPa	151	156	173	ISO 527-2/1A
Tensile modulus	5 mm/min	GPa	12.4	13.0	33.6	ASTM D638
	1 mm/min	GPa	15.7	15.5	30.4	ISO 527-2/1A
Tensile elongation at break	5 mm/min	%	2.1	1.8	0.9	ASTM D638
	5 mm/min	%	2.1	1.8	0.9	ISO 527-2/1A
Flexural strength		MPa	213	211	250	ASTM D790
		MPa	209	203	266	ISO 178
Flexural modulus		GPa	10.2	10.4	25.9	ASTM D790
		GPa	13.9	13.2	30.2	ISO 178
Compressive strength		MPa	107	121	120	ASTM D695
Izod impact, notched		J/m	69	53	53	ASTM D256
		kJ/m ²	7.4	5.8	6.8	ISO 180
Izod impact, unnotched		J/m	450	410	320	ASTM D4812
		kJ/m ²	30	28	25	ISO 180
Shear strength		MPa	71	70	70	ASTM D732
Thermal						
Heat deflection temperature ⁽²⁾	1.82 MPa	°C	267	276	278	ASTM D648
Glass transition temperature		°C	152	152	152	ASTM D3418
Melting point		°C	340	343	343	ASTM D3418
CLTE, flow direction	- 50 °C to 50 °C	ppm/°C		10	7	ASTM E831
Thermal conductivity		W/m-K	0.30	0.34	0.70	ASTM E1530
Specific heat capacity	200 °C	kJ/kg-°C	1.81	1.71	1.61	DSC
General						
Specific gravity			1.46	1.47	1.53	ASTM D792
Water absorption	24 hours	%	0.03	0.03	0.01	ASTM D570
Rockwell hardness	M scale		82	87	88	ASTM D785
Melt flow	400 °C, 2.16 kg	g/10 min	1.9	2.5	1.0	ASTM D1238
Melt viscosity	400 °C, 1000 s ⁻¹	kPa-s	0.24	0.27	0.60	ASTM D3835
Mold shrinkage, as molded flow direction	3.2 × 12.7 × 127 mm	%	0.1 – 0.3	0.1 – 0.3	0.0 – 0.2	ASTM D955
Mold shrinkage, as molded transverse direction	3.2 × 12.7 × 127 mm	%	1.7 – 1.9	1.6 – 1.8	1.2 – 1.4	ASTM D955

⁽¹⁾ Actual properties of individual batches will vary within specification limits

⁽²⁾ Measured on 3.2-mm thick specimens annealed for 2 hours at 200 °C

Table 1.8 Typical properties⁽¹⁾ of AvaSpire® PAEK unreinforced resins (US units)

Property		Units	AV-621 NT	AV-630 NT	AV-651 BG15	AV-722 BG20	AV-848 NT ⁽²⁾	Test Method
Mechanical								
Tensile strength	2 in/min	kpsi	12.2	13.3	12.6	12.7	13.6	ASTM D638
	2 in/min	kpsi	12.6	12.9	12.9	13.2		ISO 527-2/1A
Tensile modulus	2 in/min	kpsi	420	478	430	540	450	ASTM D638
	0.04 in/min	kpsi	454	492	468	563		ISO 527-2/1A
Tensile elongation at yield	2 in/min	%	6	6.0	6.2	5	6.7	ASTM D638
	2 in/min	%	5.7	5.4	5.7	4.5		ISO 527-2/1A
Tensile elongation at break	2 in/min	%	> 40	50 – 80	> 40	25	35	ASTM D638
	2 in/min	%	> 40	50 – 80	> 40	25		ISO 527-2/1A
Flexural strength		kpsi	17.7	18.4	18.0	20.4	19.4	ASTM D790
		kpsi	15.4	18.6	18.4	20.0		ISO 178
Flexural modulus		kpsi	450	465	450	540	479	ASTM D790
		kpsi	438	477	460	553		ISO 178
Compressive strength		kpsi	16.2	16.0	16.2	16.2	17.2	ASTM D695
Izod impact, notched		ft-lb/in	1.9	1.7	1.3	1.5	1.4	ASTM D256
		ft-lb/in ²	3.6	3.3	3.1	3.3		ISO 180
Izod impact, unnotched		ft-lb/in	NB ⁽³⁾	NB ⁽³⁾	NB ⁽³⁾	NB ⁽³⁾	NB ⁽³⁾	ASTM D4812
		ft-lb/in ²	NB ⁽³⁾	NB ⁽³⁾	NB ⁽³⁾	NB ⁽³⁾		ISO 180
Shear strength		kpsi	11.7	11.5	11.4	11.5	11.9	ASTM D732
Poisson's ratio			0.39		0.42	0.43		ASTM D638
Thermal								
Heat deflection temperature ⁽⁴⁾	at 264 psi	°F	369	358	374	322	486	ASTM D648
Glass transition temperature		°F	316	316	316	302	316	ASTM D3418
Melting point		°F	644	644	653	644 ⁽⁵⁾	644	ASTM D3418
CLTE, flow direction	- 58 °F to 122 °F	ppm/°F	26		26	25		ASTM E831
Thermal conductivity		Btu-in/h-ft ² -°F	1.39	1.60	1.67	1.53	1.53	ASTM E1530
Specific heat capacity	392 °F	Btu/lb-°F	0.48	0.47	0.43	0.47	0.40	DSC
Flammability	1/16		V-0		V-0			UL 94
	1/32		V-0		V-0			UL 94
Oxygen index		%	34	38		40		ASTM D2863
General								
Specific gravity			1.29	1.30	1.29	1.32	1.32	ASTM D792
Water absorption	24 hours	%	0.2	0.2	0.2	0.1	0.2	ASTM D570
Rockwell hardness	M scale		93	92	94	95		ASTM D785
Melt flow	400 °C, 2.16 kg	g/10 min	5	7	25	1		ASTM D1238
Melt viscosity	750 °F, 1000 s ⁻¹	Poise	4,100		2,400	4,500	5,000	ASTM D3835
Mold shrinkage, as molded flow direction	0.125 × 0.5 × 5 in.	%	0.7 – 0.9		0.7 – 0.9	0.8 – 1.0		ASTM D955
Mold shrinkage, as molded transverse direction	0.125 × 0.5 × 5 in.	%	1.1 – .3		1.0 – 1.2	1.2 – 1.4		ASTM D955

⁽¹⁾ Actual properties of individual batches will vary within specification limits

⁽²⁾ Values are based on limited production

⁽³⁾ NB = no break

⁽⁴⁾ Measured on 1/8-inch thick specimens annealed for 2 hours at 390 °F

⁽⁵⁾ Melting point of major component

Table 1.9 Typical properties⁽¹⁾ of AvaSpire® PAEK glass fiber reinforced resins (US units)

Property		Units	AV-621 GF30 BG20	AV-651 GF30 BG20	AV-750 GF40 NT	AV-848 GF30 NT ⁽²⁾	Test Method
Mechanical							
Tensile strength	0.2 in/min	kpsi	21.4	22.7	27.7	24.4	ASTM D638
	0.2 in/min	kpsi	22.9	23.5	27.3		ISO 527-2/1A
Tensile modulus	0.2 in/min	kpsi	1,430	1,440	2,200	1,540	ASTM D638
	0.04 in/min	kpsi	1,540	1,510	2,420		ISO 527-2/1A
Tensile elongation at break	0.2 in/min	%	3.2	2.9	1.8	2.3	ASTM D638
	0.2 in/min	%	3.2	2.9	1.8		ISO 527-2/1A
Flexural strength		kpsi	34.4	34.0	36.7	34.6	ASTM D790
		kpsi	34.2	33.1	36.3		ISO 178
Flexural modulus		kpsi	1,370	1,360	2,140	1,430	ASTM D790
		kpsi	1,420	1,410	2,230		ISO 178
Compressive strength		kpsi	23.1	24.4	26.4	20.1	ASTM D695
Izod impact, notched		ft-lb/in	2.3	2.0	1.0	1.3	ASTM D256
		ft-lb/in ²	6.8	5.5	4.0		ISO 180
Izod impact, unnotched		ft-lb/in	20	18	11	18	ASTM D4812
		ft-lb/in ²	33	30	19		ISO 180
Shear strength		kpsi	12.3	12.0	12.9	12.3	ASTM D732
Poisson's ratio			0.43				ASTM D638
Thermal							
Heat deflection temperature ⁽³⁾	at 264 psi	°F	423	415	545	495	ASTM D648
Glass transition temperature		°F	316	316	302	316	ASTM D3418
Melting point		°F	644	653	653	644	ASTM D3418
CLTE, flow direction	- 58 °F to 122 °F	ppm/°F	10	9	8		ASTM E831
Thermal conductivity		Btu-in/h-ft ² -°F	1.94	2.08	2.15	2.01	ASTM E1530
Specific heat capacity	392 °F	Btu/lb-°F	0.40	0.39	0.39	0.41	DSC
Flammability	1/16		V-0	V-0	V-0		UL 94
	1/32		V-1	V-1	V-1		UL 94
General							
Specific gravity			1.55	1.52	1.65	1.53	ASTM D792
Water absorption	24 hours	%	0.2	0.2	0.1	0.1	ASTM D570
Rockwell hardness	M scale		101	101	105		ASTM D785
Melt flow	400 °C, 2.16 kg	g/10 min	2	9	7 ⁽⁴⁾	9	ASTM D1238
Melt viscosity	750 °F, 1000 s ⁻¹	Poise	6,500	4,100	4,500	6,000	ASTM D3835
Mold shrinkage, as molded flow direction	0.125 × 0.5 × 5 in.	%	0.1 – 0.3	0.2 – 0.4	0.1 – 0.3	0.2 – 0.4	ASTM D955
Mold shrinkage, as molded transverse direction	0.125 × 0.5 × 5 in.	%	0.9 – 1.1	1.3 – 1.5	1.2 – 1.4	0.5 – 0.7	ASTM D955

⁽¹⁾ Actual properties of individual batches will vary within specification limits

⁽²⁾ Values are based on limited production

⁽³⁾ Measured on 1/8-inch thick specimens annealed for 2 hours at 390 °F

⁽⁴⁾ Conditions are 380 °C, 2.16 Kg

Table 1.10 Typical properties⁽¹⁾ of AvaSpire® PAEK carbon fiber reinforced resins (US units)

Property		Units	AV-621 CF30	AV-651 CF30	AV-722 CF30	AV-848 CF30 ⁽²⁾	Test Method
Mechanical							
Tensile strength	0.2 in/min	kpsi	26.3	26.7	29.0	25.5	ASTM D638
	0.2 in/min	kpsi	28.4	27.8	32.5		ISO 527-2/1A
Tensile modulus	0.2 in/min	kpsi	2,500	3,000	3,200	2,730	ASTM D638
	0.04 in/min	kpsi	3,380	3,060	3,860		ISO 527-2/1A
Tensile elongation at break	0.2 in/min	%	2.2	1.5	1.5	1.5	ASTM D638
	0.2 in/min	%	2.2	1.5	1.5		ISO 527-2/1A
Flexural strength		kpsi	40.1	38.0	44.1	37.6	ASTM D790
		kpsi	42.9	40.6	48.4		ISO 178
Flexural modulus		kpsi	2,200	2,500	2,800	2,400	ASTM D790
		kpsi	3,090	2,770	3,630		ISO 178
Compressive strength		kpsi	22.1	24.4	24.7	21.1	ASTM D695
Izod impact, notched		ft-lb/in	1.3	1.1	1.0	0.8	ASTM D256
		ft-lb/in ²	4.6	4.0	4.0		ISO 180
Izod impact, unnotched		ft-lb/in	12	11	10	10	ASTM D4812
		ft-lb/in ²	19	18	19		ISO 180
Shear strength		kpsi	13.3	13.7	14.2	13.8	ASTM D732
Poisson's ratio					0.44		ASTM D638
Thermal							
Heat deflection temperature ⁽³⁾	264 psi	°F	410	414	529	495	ASTM D648
Glass transition temperature		°F	320	316	302	316	ASTM D3418
Melting point		°F	644	653	644 ⁽⁴⁾	644	ASTM D3418
CLTE, flow direction	- 58 °F to 122 °F	ppm/°F	3	5	3		ASTM E831
Thermal conductivity		Btu-in/h-ft ² -°F	2.43	2.50	2.36	2.56	ASTM E1530
Specific heat capacity	392 °F	Btu/lb-°F	0.43	0.42	0.42		DSC
General							
Specific gravity			1.42	1.42	1.42	1.42	ASTM D792
Water absorption	24 hours	%	0.1	0.2	0.1	0.1	ASTM D570
Rockwell hardness	M scale		101	104	107		ASTM D785
Melt flow	400 °C, 2.16 kg	g/10 min	1.0	4.5	0.8	3.5	ASTM D1238
Melt viscosity	750 °F, 1000 s ⁻¹	Poise	7,900	5,400	4,700		ASTM D3835
Mold shrinkage, as molded flow direction	0.125 × 0.5 × 5 in.	%	0.0 – 0.2	0.0 – 0.2	0.0 – 0.2	0.0 – 0.2	ASTM D955
Mold shrinkage, as molded transverse direction	0.125 × 0.5 × 5 in.	%	0.9 – 1.1	0.9 – 1.1	0.4 – 1.6	0.4 – 0.6	ASTM D955

⁽¹⁾ Actual properties of individual batches will vary within specification limits

⁽²⁾ Values are based on limited production

⁽³⁾ Measured on 1/8-inch thick specimens annealed for 2 hours at 390 °F

⁽⁴⁾ Melting point of major component

Table 1.11 Typical properties⁽¹⁾ of AvaSpire® PAEK wear resistant resins (US units)

Property		Units	AV-722 SL30	AV-742 SL30	AV-755 SL45	Test Method
Mechanical						
Tensile strength	0.2 in/min	kpsi	19.7	20.7	24.5	ASTM D638
	0.2 in/min	kpsi	21.9	22.6	25.1	ISO 527-2/1A
Tensile modulus	0.2 in/min	kpsi	1,800	1,880	4,870	ASTM D638
	0.04 in/min	kpsi	2,280	2,250	4,410	ISO 527-2/1A
Tensile elongation at break	0.2 in/min	%	2.1	1.8	0.9	ASTM D638
	0.2 in/min	%	2.1	1.8	0.9	ISO 527-2/1A
Flexural strength		kpsi	30.9	30.6	36.2	ASTM D790
		kpsi	30.3	29.4	38.6	ISO 178
Flexural modulus		kpsi	1,480	1,510	3,760	ASTM D790
		kpsi	2,020	1,910	4,380	ISO 178
Compressive strength		kpsi	15.5	17.6	17.4	ASTM D695
Izod Impact, notched		ft-lb/in	1.3	1.0	1.0	ASTM D256
		ft-lb/in ²	3.5	2.8	3.2	ISO 180
Izod Impact, unnotched		ft-lb/in	9	8	6	ASTM D4812
		ft-lb/in ²	14	13	12	ISO 180
Shear strength		kpsi	10.3	10.1	10.1	ASTM D732
Thermal						
Heat deflection temperature ⁽²⁾	264 psi	°F	513	529	532	ASTM D648
Glass transition temperature		°F	305	305	305	ASTM D3418
Melting point		°F	644	649	649	ASTM D3418
CLTE, flow direction	- 58 °F to 122 °F	ppm/°F		5	4	ASTM E831
Thermal conductivity		Btu-in/h-ft ² -°F	2.08	2.36	4.86	ASTM E1530
Specific heat capacity	392 °F	Btu/lb-°F	0.43	0.41	0.38	DSC
General						
Specific gravity			1.46	1.47	1.53	ASTM D792
Water absorption	24 hours	%	0.03	0.03	0.01	ASTM D570
Rockwell hardness	M scale		82	87	88	ASTM D785
Melt flow	400 °C, 2.16 kg	g/10 min	1.9	2.5	1.0	ASTM D1238
Melt viscosity	750 °F, 1000 s ⁻¹	Poise	2,400	2,700	6,000	ASTM D3835
Mold shrinkage, as molded flow direction	0.125 × 0.5 × 5 in.	%	0.1 – 0.3	0.1 – 0.3	0.0 – 0.2	ASTM D955
Mold shrinkage, as molded transverse direction	0.125 × 0.5 × 5 in.	%	1.7 – 1.9	1.6 – 1.8	1.2 – 1.4	ASTM D955

⁽¹⁾ Actual properties of individual batches will vary within specification limits

⁽²⁾ Measured on 1/8-inch thick specimens annealed for 2 hours at 390 °F

Table 1.12 Electrical properties⁽¹⁾ of AvaSpire® PAEK unreinforced resins

Property	Units	AV-621 NT	AV-630 NT	AV-651 BG15	AV-722 BG20	AV-848 NT ⁽²⁾	Test Method
Electrical							
Volume resistivity	ohm-cm	6.2×10^{17}	6.2×10^{17}	5.0×10^{17}	3.1×10^{17}	6.0×10^{16}	ASTM D257
Surface resistivity	ohm	$> 1.9 \times 10^{17}$	$> 1.9 \times 10^{17}$	$> 1.9 \times 10^{17}$	$> 1.9 \times 10^{17}$	$> 1.9 \times 10^{17}$	ASTM D257
Dielectric strength							
3 mm (0.125 in.)	kV/mm (V/mil)	16.6 (422)		15.8 (403)	19.3 (491)	19.9 (506)	ASTM D149
0.05 mm (0.002 in.) ⁽³⁾	kV/mm (V/mil)	191 (4,850)		184 (4,680)		169 (4,300)	ASTM D149
Dielectric constant							
	60 Hz	3.10		3.10	3.12	3.21	ASTM D150
	10^3 Hz	3.12		3.12		3.23	
	10^6 Hz	3.07		3.10	3.06	3.18	
Dissipation factor							
	60 Hz	0.001		0.001	0.001	0.002	ASTM D150
	10^3 Hz	0.001		0.001		0.001	
	10^6 Hz	0.004		0.004	0.004	0.006	

⁽¹⁾ Actual properties of individual batches will vary within specification limits

⁽²⁾ Values are based on limited production

⁽³⁾ Amorphous film

Table 1.13 Electrical properties⁽¹⁾ of AvaSpire® PAEK glass fiber reinforced resins

Property	Units	AV-621 GF30 BG20	AV-651 GF30 BG20	AV-750 GF40 NT	AV-848 GF30 NT ⁽²⁾	Test Method
Electrical						
Volume resistivity	ohm-cm	2.1×10^{17}	2.0×10^{17}	1.8×10^{17}	1.8×10^{17}	ASTM D257
Surface resistivity	ohm	$> 1.9 \times 10^{17}$	$> 1.9 \times 10^{17}$	$> 1.9 \times 10^{17}$	$> 1.9 \times 10^{17}$	ASTM D257
Dielectric strength	3 mm (0.125 in.) kV/mm (V/mil)	15.0 (383)	17.0 (433)	18.7 (476)	17.6 (446)	ASTM D149
Dielectric constant						
	60 Hz	3.52	3.61	3.68	3.74	ASTM D150
	10^3 Hz	3.53	3.63	3.69		
	10^6 Hz	3.48	3.58	3.66	3.69	
Dissipation factor						
	60 Hz	0.001	0.002	0.002	0.002	ASTM D150
	10^3 Hz	0.001		0.001		
	10^6 Hz	0.005	0.004	0.003	0.006	

⁽¹⁾ Actual properties of individual batches will vary within specification limits

⁽²⁾ Values are based on limited production

Agency Approvals

AvaSpire® polyaryletherketone (PAEK) resins comply with the requirements of several governmental and/or regulatory agencies, as outlined in this document. As regulatory action is an ongoing activity, please contact your Solvay representative for the latest information regarding a specific application requiring agency approval or recognition.

Food Contact

United States Food and Drug Administration (FDA)

AvaSpire® PAEK resins are cleared for their intended use under existing food contact regulations in 21 CFR and/or in an effective Food Contact Notification. Therefore, some AvaSpire® PAEK grades are permitted by FDA for use as articles or components of articles intended for repeated use in contact with food under FDA conditions B through H.

European Commission Directive No 10/2011

Commission Directive Relating to Plastic Materials and Articles Intended to Come in Contact with Foodstuffs

Several grades of AvaSpire® PAEK are compliant under each of these standards. Information on current listings for specific grades is available from your Solvay representative.

ISO 10993

Several grades of AvaSpire® PAEK comply with the requirements of ISO 10993; therefore they are generally suitable for use in Class II and Class III medical devices. Please consult your Solvay representative for further details.

Only Solvay products designated as part of the Solviva® Biomaterials product family may be considered as candidates for use in implantable medical devices that are in contact with bodily fluids or tissues for more than 24 hours.

Underwriters Laboratories

Several commercial grades of AvaSpire® PAEK are listed in Underwriters Laboratories Recognized Component Directory. For the most current listings, please go to www.specialtypolymersdatasheets.com and click on the UL icon next to the grade of interest.

ASTM International

AvaSpire® PAEK resins can be specified using ASTM D4000.

Short-Term Mechanical Properties

Material suppliers provide product data listing typical mechanical properties to provide design engineers with the ability to compare materials and to aid in material selection for the components being designed. The values provided are determined using standardized test specimens by test methods optimized to give reproducible, reliable results. In general, these data are suitable for comparing similar materials, but should not be used for design engineering calculations without careful consideration of many factors such as strain rates, stress concentration, environmental effects, and end use requirements.

When considering the mechanical properties, the immediate or short-term effect of load, the effect of long-term sustained load, and the effect of repeated loading and unloading are all important. In addition, the ambient temperature and the chemical environment can also affect the mechanical performance of a material. This section deals primarily with the short-term effect of load and temperature.

If the application is subjected to sustained load, then creep must be considered and creep is addressed in a separate section. If the load is cyclical, then fatigue may be the limiting factor and fatigue data is also presented in the section – “Long-Term Mechanical Properties”. If the application will be subjected to high temperatures for extended time periods, then thermal stability may be a consideration and thermal stability data is presented in the Thermal Stability section.

The properties presented in this section are Poisson’s ratio, tensile properties, flexural properties, compressive properties, and shear properties. All of these tests measure response to external load. They differ primarily in the manner the load is applied.

In tensile testing, the ends of the bar are clamped into jaws and the jaws are separated causing the bar to stretch. In flexural testing, a bar rests on two supports while load is applied in the center causing the bar to bend. In compressive testing, a sample is placed upright between parallel plates and load is applied pushing the plates together. In shear testing, a sample is supported on a plate with a hole in the center and a punch is driven through the sample into the hole.

Poisson’s Ratio

Poisson’s ratio (ν) is the negative ratio of lateral strain to longitudinal strain within the proportional limit. To illustrate, consider a cylindrical bar subjected to tensile stress. The length of the bar increases and simultaneously its diameter decreases. In this case, Poisson’s ratio would be calculated by dividing the change in diameter by the change in length.

Most materials have Poisson’s ratio values ranging between 0.0 and 0.5. A perfectly incompressible material deformed elastically at small strains would have a Poisson’s ratio of exactly 0.5. Most steels and rigid polymers when used within their design limits exhibit values of about 0.3. Rubber has a Poisson’s ratio of nearly 0.5.

The ASTM test method D638 was used to determine the Poisson’s ratio of several grades of AvaSpire® polyaryletherketone (PAEK). Type 1 tensile specimens were used at a crosshead speed of 5 mm/min (0.2 in./min.). Prior to testing specimens were conditioned according to ASTM D618. The values obtained are shown in Table 3.1.

Table 3.1 Poisson’s ratio of selected AvaSpire® PAEK grades

Grade	Poisson’s Ratio ⁽¹⁾
AV-621 NT	0.39
AV-651 BG15	0.42
AV-621 GF30 BG20	0.43
AV-722 BG20	0.43
AV-722 CF30	0.44

⁽¹⁾ Poisson’s ratio is a required input for the finite element analysis (FEA) programs that are used to estimate the response of an object to applied stress.

Tensile Properties

The tensile properties typically listed on a data sheet are tensile strength, tensile modulus, and tensile elongation. For ductile materials, the tensile strength at yield may be listed, as well as the tensile strength at break.

Tensile properties are determined by clamping a test specimen into the jaws of a testing machine and separating the jaws at a specified rate. The force required to separate the jaws divided by the minimum cross-sectional area is defined as the tensile stress. A test specimen will elongate as a result of the stress, and the amount of elongation divided by the original length is the strain. If the applied stress is plotted against the resulting strain, curves similar to those shown in Figure 3.1 are obtained. Unreinforced resins often exhibit ductile behavior while fiber reinforced resins exhibit brittle behavior.

Figure 3.1 Typical stress/strain curve

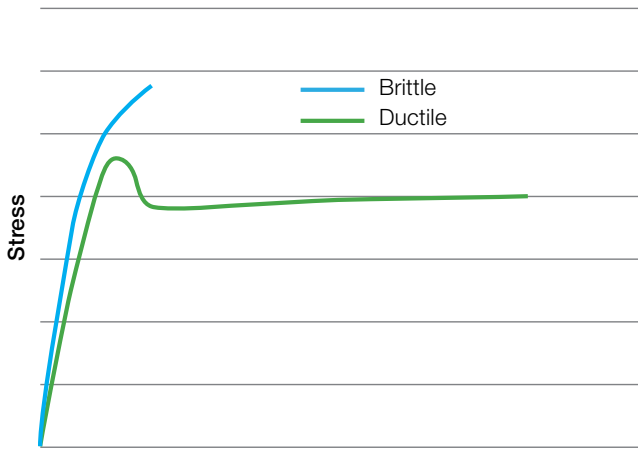

The initial portion of a stress/strain curve is of special interest, and is shown in Figure 3.2. This figure shows that strain is directly proportional to stress, up to a certain level of stress. This region is known as the “Hookean” region, and the limiting stress is known as the proportional limit. The tensile modulus is the slope of the stress/strain curve when a specimen is subjected to a tensile loading. Measuring the slope of a curved line is difficult, and some conventions have been developed to standardize the testing and reduce the variability in test results. One method uses the slope of a line drawn tangent to the curve, and another method utilizes the slope of a secant drawn through the origin and some arbitrarily designated strain level. Today most tensile testing machines are computerized and the software calculates the tangent modulus from the stresses at 0.05 % and 0.25 % strain. All of the tensile modulus data in this document was tangent modulus calculated by the testing machine software.

Figure 3.2 Tensile modulus calculation

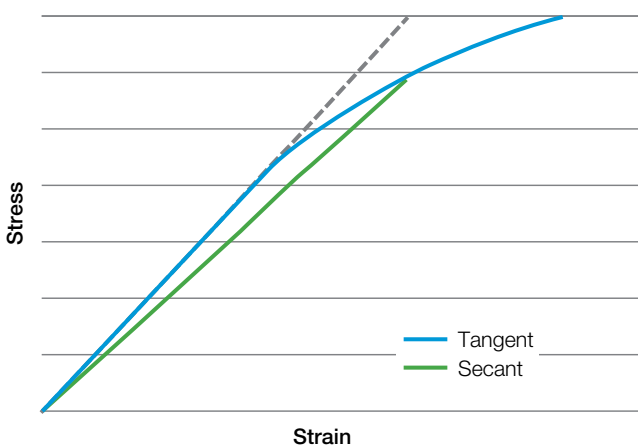

Ductile polymers undergo yield prior to rupture. At the onset of jaw separation, the stress or force required to elongate the specimen is directly proportional to the elongation or strain. In this region, the deformation is said to be elastic. Ideally, if the load were removed, the specimen would return to its original length. As jaw separation proceeds and the stress increases, the specimens exhibit greater amounts of deformation until the point where additional elongation is achieved without additional stress. The deformation has transitioned from elastic to plastic. If the load were to be removed at this point, the specimens would not return to their original size. At least, some of the deformation is permanent.

As seen in Figure 3.1, there is a local maximum stress that is commonly called the yield stress or tensile strength at yield. The strain at this point is commonly called the elongation at yield. As the jaws continue to separate, the specimens continues to elongate until rupture occurs. The stress at rupture is called the tensile strength at break and the corresponding strain is called the elongation at break. The shape of the stress/strain curve is somewhat distorted by the fact that the original cross-sectional area is used to calculate the stress, but the actual area is getting smaller as the specimen elongates.

The test methods commonly used for determining tensile properties of plastics, ASTM D638 or ISO 527, define tensile strength as the greater of the stress at yield or the stress at rupture. These two test methods measure the same property, but use slightly different test specimens and test procedures. The test methods specify that the testing speed should be the lowest speed that results in rupture within 0.5 to 5 minute testing time. If this criteria is applied, then ductile materials (unreinforced grades) will usually be tested at 50 mm/min (2 inch/min) and fiber reinforced grades will be tested at 5 mm/min (0.2 inch/min). The speed of testing does affect the results and it is important to verify that the proper speed was used before comparing materials. If a ductile material is tested using the slow speed the tensile strength will be lower, but the elongation may be higher.

When comparing tensile strength data from multiple sources, only data obtained using the same test method and the same testing speed should be considered.

Fibrous Reinforcement

Figure 3.3 shows the room-temperature stress/strain curves for an unreinforced grade, a glass-fiber reinforced grade, and a carbon-fiber reinforced grade. Figure 3.4 shows that tensile strength is enhanced by reinforcing fibers.

Figure 3.3 Room temperature stress/strain curves for neat and fiber-reinforced grades

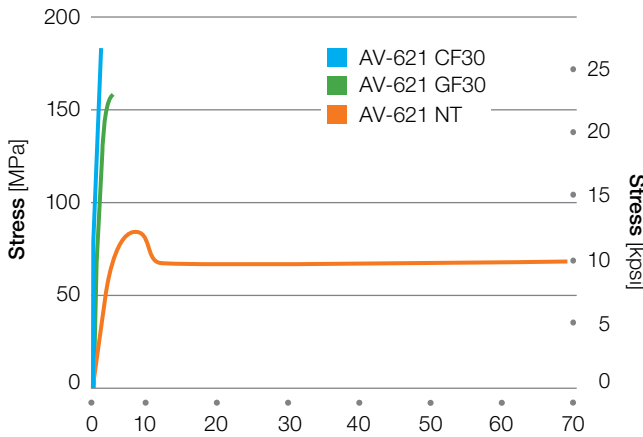
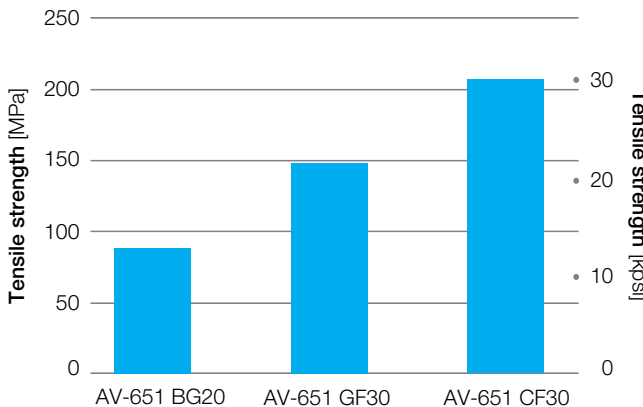
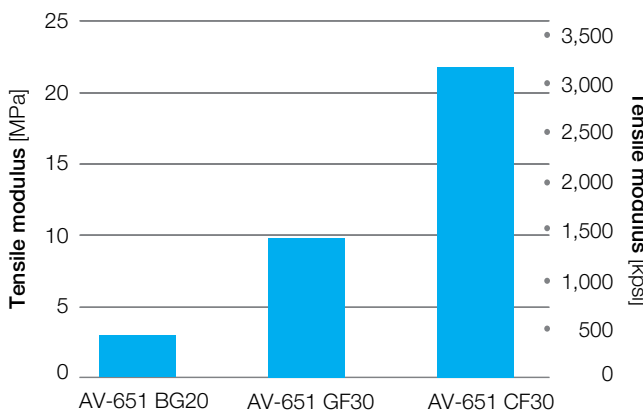

Figure 3.4 Tensile strength and fiber reinforcement



The addition of fibrous reinforcement causes a substantial increase in tensile modulus. Carbon fiber is even more effective than glass fiber in increasing modulus as seen in Figure 3.5.

Figure 3.5 Tensile modulus and fiber reinforcement



The increases in strength and modulus are coupled with a reduction in ductility. The elongation at break of fiber reinforced grades is limited by the elongation of the fiber as shown in Figure 3.6.

Figure 3.6 Tensile elongation and fiber reinforcement

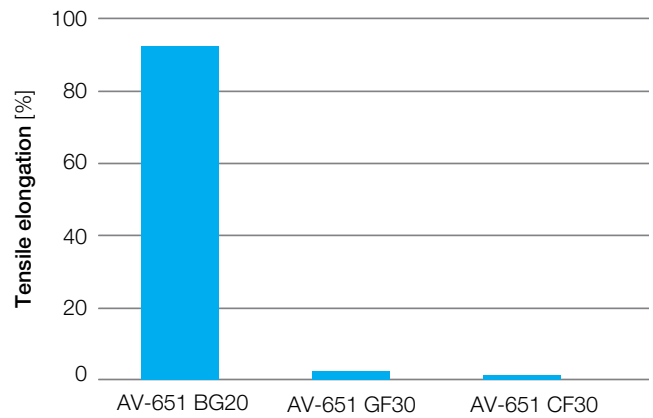

The changes in properties with reinforcement should be taken into account in part design.

Temperature

As ambient temperatures are increased, thermoplastics soften until they become fluid. Semi-crystalline polymers such as AvaSpire® PAEK exhibit modest decreases in strength and modulus as the temperature is raised to the glass transition temperature (T_g). At the T_g , a rapid decrease occurs to a plateau region where the properties remain almost constant until the melting point (T_m) is reached. Semi-crystalline resins often can be used in ambient temperatures above their glass transition temperatures, but below their melting points. The addition of fibrous reinforcement to semi-crystalline polymers allows for retention of strength and modulus at temperatures above the T_g . The retention of tensile strength at elevated temperatures is shown in Figures 3.7, 3.8 and 3.9.

Figure 3.7 Tensile strength vs. temperature AvaSpire® AV-600 Series

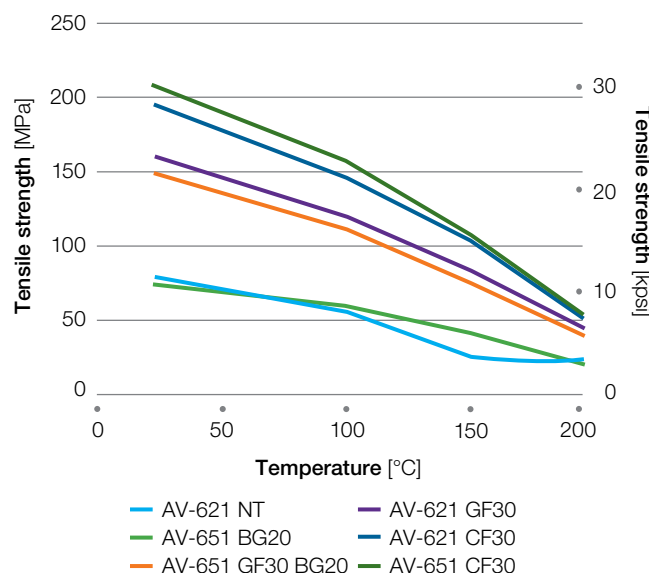

Figure 3.8 Tensile strength vs. temperature
AvaSpire® AV-700 Series

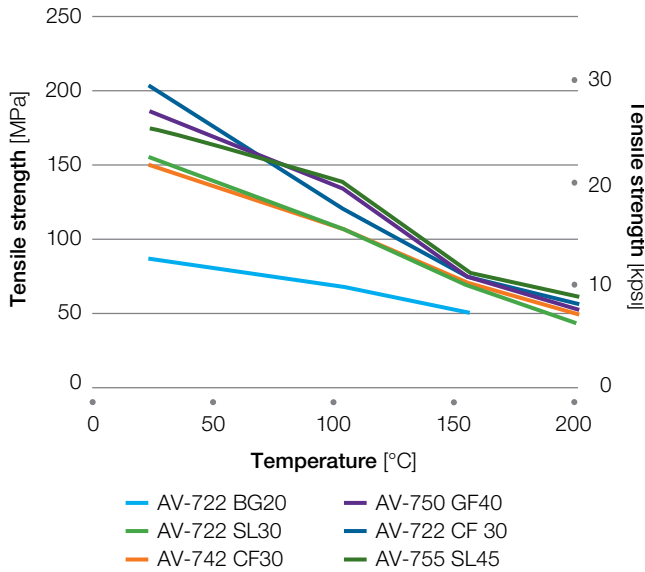
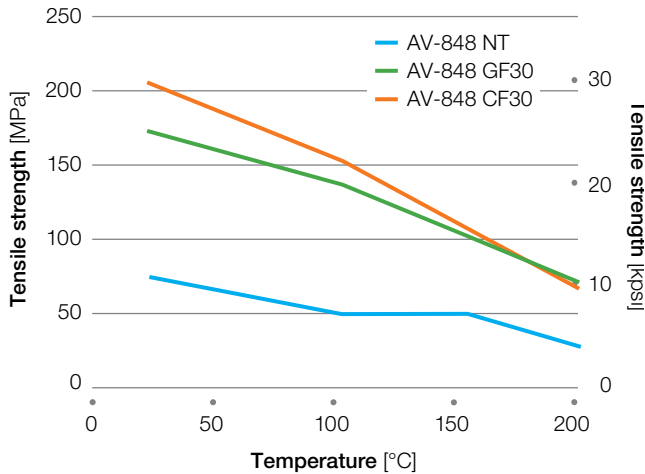

Figure 3.9 Tensile strength vs. temperature
AvaSpire® AV-800 series



The changes in strength and modulus with temperature can also be observed in stress/strain curves generated at multiple temperatures.

Stress/Strain Curves

Typically, tensile property data are presented by tabulating specific data, such as tensile strength, tensile modulus, and elongation. While these data are generally adequate for most purposes, the actual stress/strain curves provide additional information about a material's response to load that design engineers may find useful when they estimate the viability of a part design.

Figures 3.10 through 3.24 show the stress/strain curves for 15 AvaSpire® PAEK grades generated at multiple temperatures. As the test temperature is increased the tensile strength lowers. The modulus indicated by the initial slope of the curve also decreases. In contrast, the softening of the material leads to significant increases in the ductility.

Figure 3.10 AvaSpire® AV-621 NT

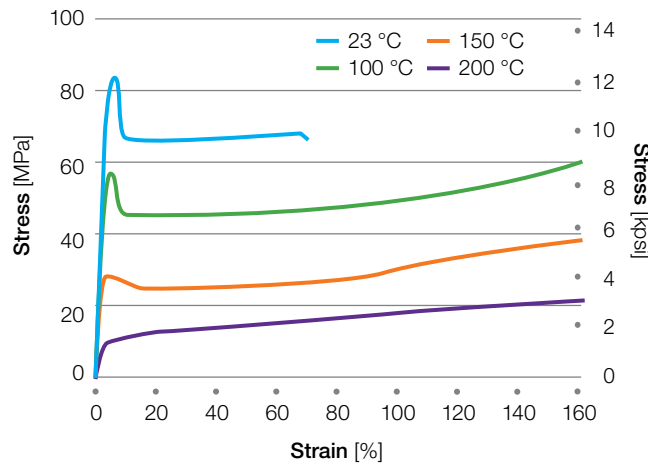

Figure 3.11 AvaSpire® AV-651 BG15

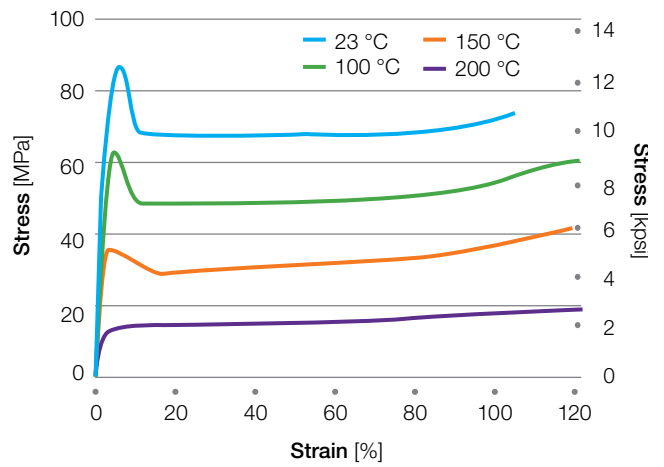

Figure 3.12 AvaSpire® AV-722 BG20

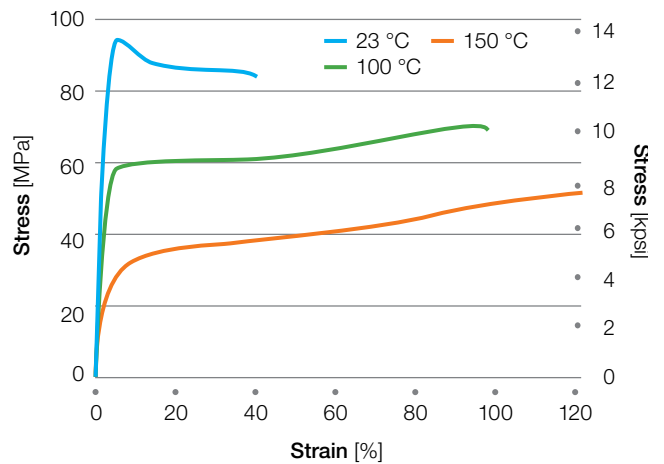

Figure 3.13 AvaSpire® AV-848 NT

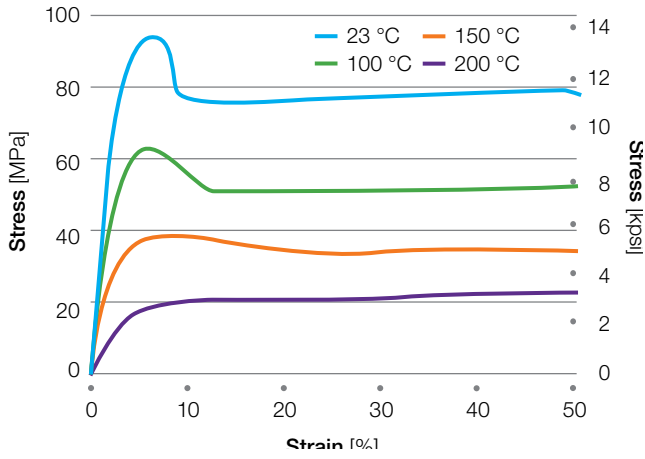

Figure 3.16 AvaSpire® AV-750 GF40

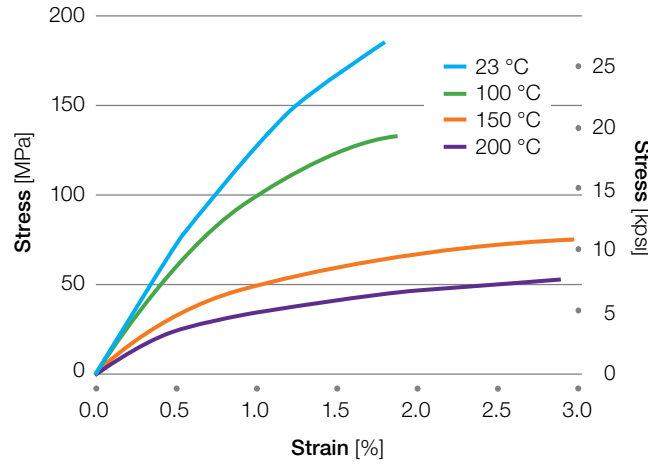

Figure 3.14 AvaSpire® AV-621 GF30

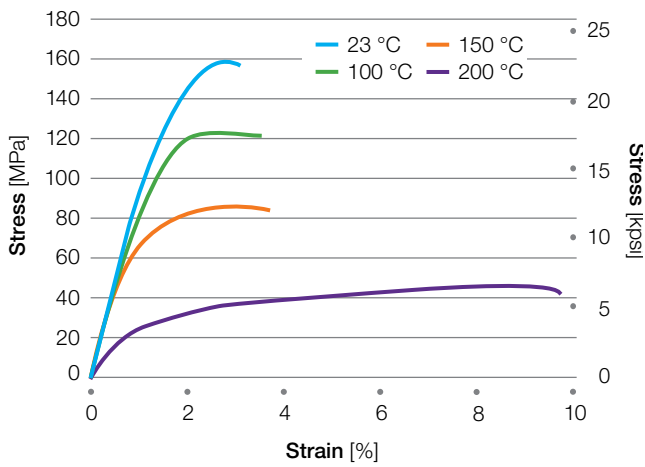

Figure 3.17 AvaSpire® AV-848 GF30

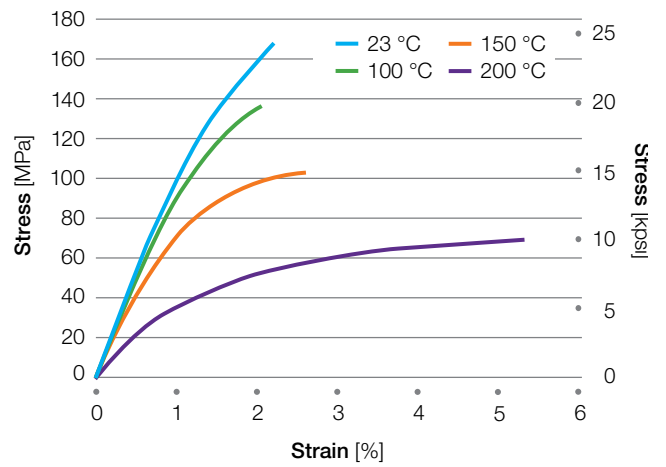

Figure 3.15 AvaSpire® AV-651 GF30

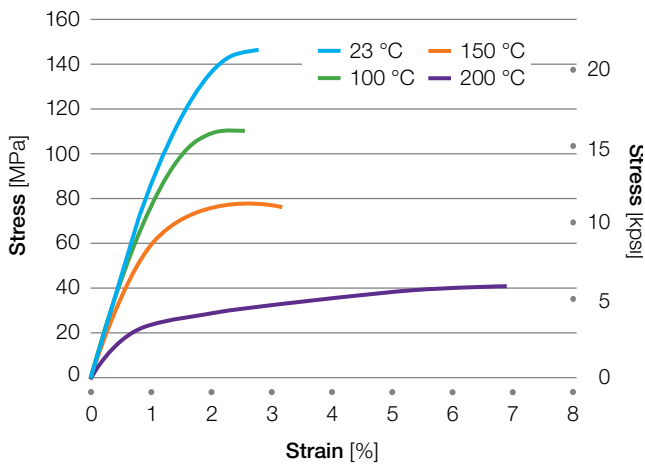

Figure 3.18 AvaSpire® AV-621 CF30

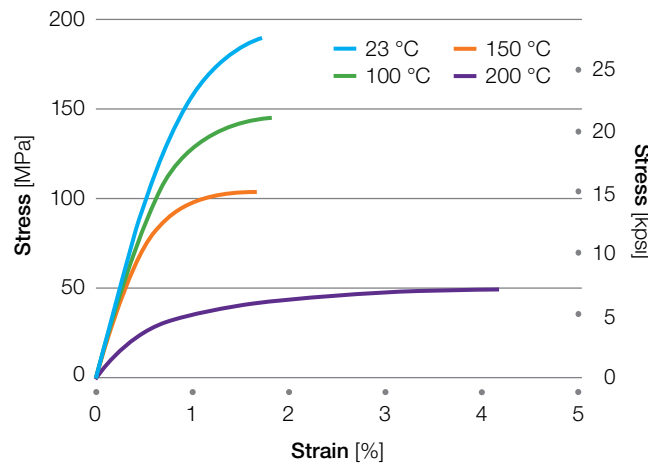

Figure 3.19 AvaSpire® AV-651 CF30

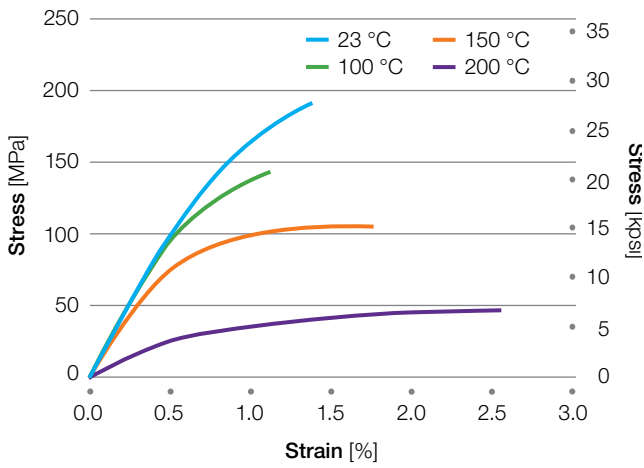

Figure 3.22 AvaSpire® AV-722-SL30

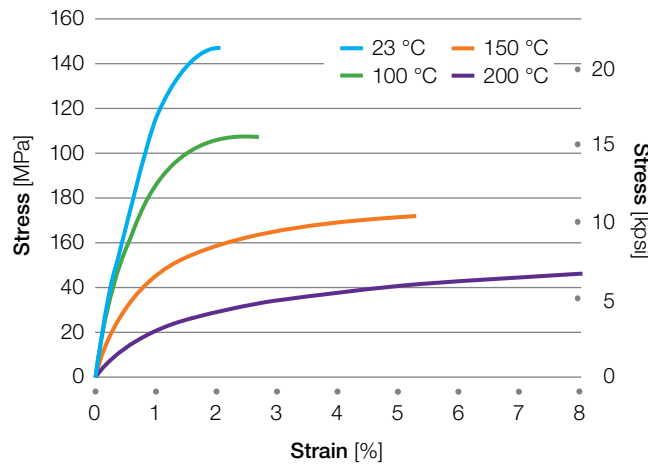

Figure 3.20 AvaSpire® AV-722 CF30

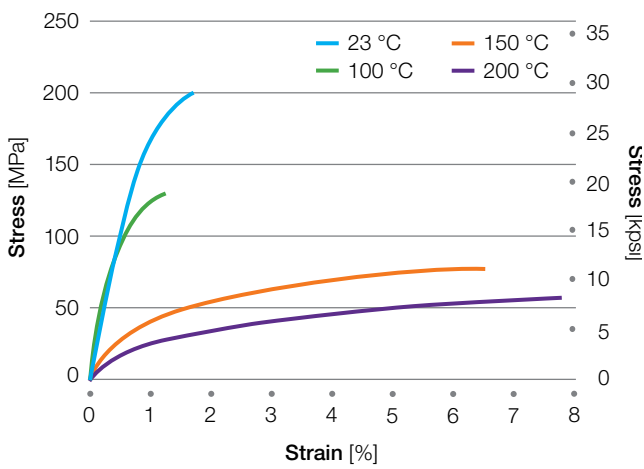

Figure 3.23 AvaSpire® AV-742 SL30

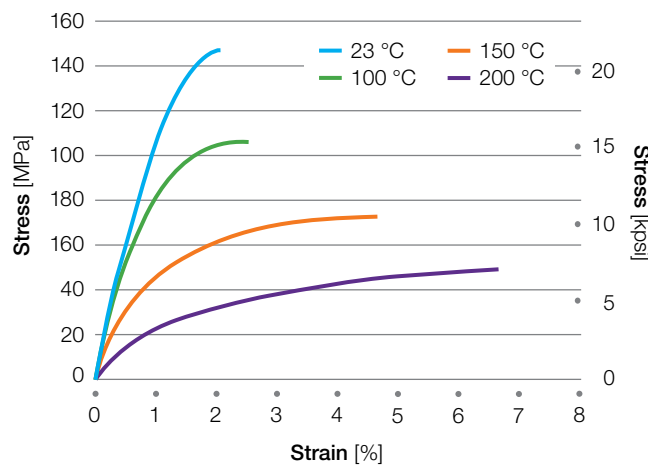

Figure 3.21 AvaSpire® AV-848 CF30

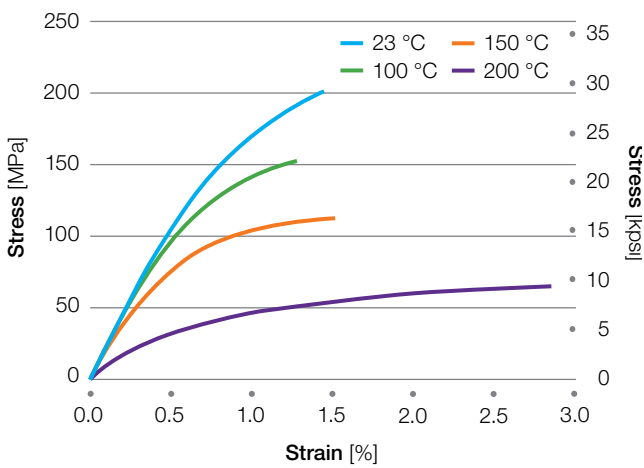
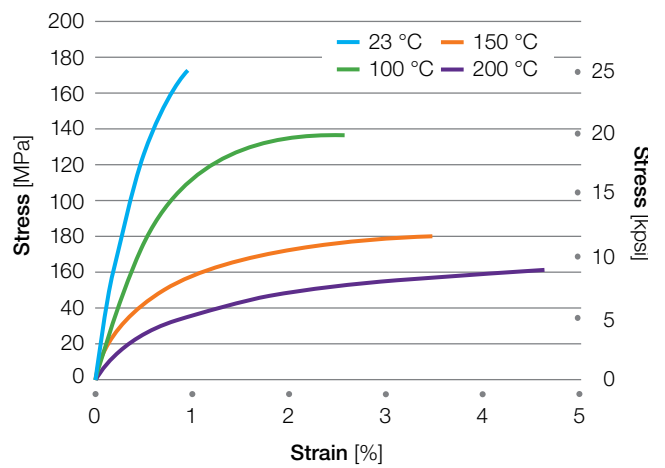

Figure 3.24 AvaSpire® AV-755 SL45



Tables 3.2 through 3.5 give the tensile properties of AvaSpire® PAEK at room and elevated temperature. The data were generated according to ASTM D638. The dimensions of the environmental chamber used for high-temperature testing limits the extension of samples to about 120 % of initial specimen length. Testing on samples whose elongation exceeded that limit were terminated and the value at 120 % elongation was reported.

Table 3.2 Tensile properties at elevated temperature for unreinforced AvaSpire® PAEK grades

Temperature [°C (°F)]	Unit	AvaSpire® AV-621 NT	AvaSpire® AV-651 BG20	AvaSpire® AV-722 BG20	AvaSpire® AV-848 NT
Tensile strength at yield					
23 (73)	MPa (kpsi)	77 (11.2)	88 (12.7)	95 (13.8)	94 (13.6)
100 (212)	MPa (kpsi)	55 (7.9)	61 (8.8)	58 (8.4)	62 (8.9)
150 (302)	MPa (kpsi)	25 (3.6)	33 (4.8)		33 (4.8)
200 (392)	MPa (kpsi)		14 (2.1)		
Tensile strength at break					
23 (73)	MPa (kpsi)	68 (10.0)	73 (10.6)	85 (12.3)	73 (10.6)
100 (212)	MPa (kpsi)	59(8.6)	59 (8.5)	67 (9.8))	49 (7.1)
150 (302)	MPa (kpsi)	37 (5.4)	40 (5.8)	50 (7.2)	48 (6.9)
200 (392)	MPa (kpsi)	23 (3.3)	19 (2.7)		26 (3.8)
Tensile modulus					
23 (73)	GPa (kpsi)	3.0 (429)	3.1 (453)	4.0 (586)	3.1 (450)
100 (212)	GPa (kpsi)	2.6 (374)	2.2 (316)	2.5 (357)	2.9 (415)
150 (302)	GPa (kpsi)	1.6 (232)	1.8 (254)	1.4 (208)	1.4 (208)
200 (392)	GPa (kpsi)	0.6 (8.7)	0.6 (8.7)		1.4 (208)
Tensile elongation at yield					
23 (73)	%	6.2	6.4	5.4	7.0
100 (212)	%	4.0	5.0	13	5.8
150 (302)	%	4.0	4.5		5.4
200 (392)	%		14		
Tensile elongation at break					
23 (73)	%	64	93	35	35
100 (212)	%	120*	120*	91	53
150 (302)	%	120*	120*	120*	70
200 (392)	%	120*	120*		92

*120 = limit of testing machine

Table 3.3 Tensile properties at elevated temperature for glass fiber reinforced AvaSpire® PAEK grades

Temperature [°C (°F)]	Unit	AvaSpire® AV-621 GF30	AvaSpire® AV-651 GF30 BG20	AvaSpire® AV-750 GF40	AvaSpire® AV-848 GF30
Tensile strength at break					
23 (73)	MPa (kpsi)	160 (23.2)	148 (21.4)	185 (26.8)	171 (24.8)
100 (212)	MPa (kpsi)	120 (17.4)	111 (16.1)	132 (19.1)	136 (19.7)
150 (302)	MPa (kpsi)	82 (11.9)	74 (10.8)	74 (10.8)	101 (14.6)
200 (392)	MPa (kpsi)	41 (6.0)	35 (5.1)	50 (7.3)	67 (9.7)
Tensile modulus					
23 (73)	GPa (kpsi)	10.4 (1,510)	9.9 (1,430)	15.7 (2,280)	11.3 (1,640)
100 (212)	GPa (kpsi)	9.9 (1,430)	9.1 (1,320)	13.8 (2,000)	10.7 (1,550)
150 (302)	GPa (kpsi)	9.1 (1,320)	7.7 (1,110)	7.8 (1,130)	9.3 (1,350)
200 (392)	GPa (kpsi)	3.1 (452)	3.6 (515)	5.2 (753)	4.4 (639)
Tensile elongation at break					
23 (73)	%	2.8	2.7	1.7	2.1
100 (212)	%	2.7	2.4	1.8	1.9
150 (302)	%	3.5	3.1	2.9	2.5
200 (392)	%	9.3	6.7	2.8	5.1

Table 3.4 Tensile properties at elevated temperature for carbon fiber reinforced AvaSpire® PAEK grades

Temperature [°C (°F)]	Unit	AvaSpire® AV-621 CF30	AvaSpire® AV-651 CF30	AvaSpire® AV-722 CF30	AvaSpire® AV-848 CF30
Tensile strength at break					
23 (73)	MPa (kpsi)	194 (28.2)	207 (30.0)	201 (29.2)	204 (29.6)
100 (212)	MPa (kpsi)	146 (21.2)	155 (22.5)	119 (17.3)	152 (22.0)
150 (302)	MPa (kpsi)	103 (14.9)	105 (15.2)	76 (11.0)	106 (15.4)
200 (392)	MPa (kpsi)	45 (6.5)	48 (6.9)	54 (7.8)	63 (9.2)
Tensile modulus					
23 (73)	GPa (kpsi)	21.2 (3,070)	21.9 (3,170)	21.6 (3,160)	22.8 (3,300)
100 (212)	GPa (kpsi)	20.3 (2,950)	21.4 (3,110)	23.5 (3,410)	21.5 (3,120)
150 (302)	GPa (kpsi)	19.1 (2,770)	18.7 (2,710)	6.7 (966)	17.8 (2,580)
200 (392)	GPa (kpsi)	6.7 (974)	6.7 (977)	3.2 (471)	7.9 (1,140)
Tensile elongation at break					
23 (73)	%	1.6	1.6	1.7	1.4
100 (212)	%	1.6	1.6	1.8	1.2
150 (302)	%	1.6	1.7	2.9	1.4
200 (392)	%	4.1	3.7	2.8	2.8

Table 3.5 Tensile properties at elevated temperature for wear-resistant AvaSpire® PAEK grades

Temperature	Unit	AvaSpire® AV-722 SL30	AvaSpire® AV-742 SL30	AvaSpire® AV-755 SL45
Tensile strength at break				
23 (73)	MPa (kpsi)	152 (22.0)	149 (21.6)	174 (25.2)
100 (212)	MPa (kpsi)	105 (15.2)	106 (15.4)	137 (19.9)
150 (302)	MPa (kpsi)	68 (10.0)	69 (10.0)	79 (11.4)
200 (392)	MPa (kpsi)	40 (5.8)	46 (6.7)	60 (8.7)
Tensile modulus				
23 (73)	GPa (kpsi)	14.7 (2,130)	13.9 (2,020)	34.5 (5,010)
100 (212)	GPa (kpsi)	12.7 (1,840)	11.7 (1,690)	18.3 (2,660)
150 (302)	GPa (kpsi)	7.9 (1,140)	6.9 (995)	12.8 (1,860)
200 (392)	GPa (kpsi)	2.4 (349)	2.7 (396)	6.5 (937)
Tensile elongation at break				
23 (73)	%	2.0	1.8	0.9
100 (212)	%	2.7	2.3	2.5
150 (302)	%	5.2	4.5	3.4
200 (392)	%	7.7	6.4	4.6

Flexural Properties

Several tests are used to determine the strength and stiffness of plastic materials. The goal of these tests is to provide a basis for comparing various plastics and to help predict performance under load in actual applications. The simplest test is the flexural properties test, which simulates the deflection or bending of a beam from a load applied to the center while the beam is supported at two points.

The test specimen is a flat rectangular bar that can be easily molded or machined from sheet. The testing machine doesn't need special grips or sophisticated extensometers. In the test, the specimen is supported at two points and loaded in the center until it breaks or the maximum deflection is reached.

When the specimen is loaded, the portion of the specimen directly under the load is subjected to compressive stress while the outer fiber is subjected to tensile stress. Because the typical mode of failure is a tensile failure, one might expect the flexural strength to be similar to the tensile strength. However, the compressive component generally results in a higher value for flexural strength. Because both tensile and compressive stresses are involved, the results are best suited for comparison of materials. Other tests are available that measure tensile strength and compressive strength separately; values from those tests are considered more useful for engineering purposes.

Test Methods for Flexural Properties

The common test methods for measuring the flexural properties of plastic materials are ASTM D790-10 and ISO 178:2010(E). These tests are not suitable for very ductile, low modulus materials because under the specified conditions, the specimens do not break and may actually slip between the supports. Several grades of AvaSpire® polyaryletherketone (PAEK) were tested by both methods and the results are presented in the Table 3.6.

The specimens used for flexural testing according to ASTM test method D790 were injection molded bars measuring 127 × 12.7 × 3.2 mm (5.0 × 0.5 × 0.125 inch). The support span was 50.8 mm (2.0 inch), which corresponds to the required span to depth ratio of 16:1. The testing speed was 1.35 mm/min (0.05 inch/min). The load is applied until the sample breaks or the strain limit of 5 % is reached. The modulus is calculated by the tangent method by the testing machine software. The strength is calculated by the stress at break. If the specimen doesn't break, the stress is calculated at 5 % strain.

Table 3.6 Flexural strength and modulus of AvaSpire® PAEK

Grade	Flexural Strength [MPa (kpsi)]		Flexural Modulus [GPa (kpsi)]	
	ASTM D790	ISO 178	ASTM D790	ISO 178
AV-621 NT	122 (17.7)	106 (15.4)	3.10 (450)	3.00 (438)
AV-630 NT	127 (18.4)	128 (18.6)	3.20 (465)	3.30 (477)
AV-651 BG15	124 (18.0)	127 (18.4)	3.10 (450)	3.20 (460)
AV-722 BG20	141 (20.4)	138 (20.0)	3.70 (540)	3.80 (553)
AV-848 NT	134 (19.4)		3.30 (479)	
AV-621 GF30 BG20	237 (34.4)	236 (34.2)	9.40 (1,370)	9.80 (1,420)
AV-651 GF30 BG20	234 (34.0)	228 (33.1)	9.40 (1,360)	9.70 (1,410)
AV-750 GF40 NT	253 (36.7)	250 (38.3)	14.8 (2,140)	15.4 (2,230)
AV-848 GF30 NT	239 (34.6)		9.90 (1,430)	
AV-621 CF30	277 (40.1)	296 (42.9)	15.1 (2,200)	21.3 (3,090)
AV-651 CF30	262 (38.0)	280 (40.6)	17.2 (2,500)	19.1 (2,770)
AV-722 CF30	304 (44.1)	334 (48.4)	19.3 (2,800)	25.0 (3,630)
AV-848 CF30	259 (37.8)		16.5 (2,400)	
AV-722 SL30	213 (30.9)	209 (30.3)	10.2 (1,480)	13.9 (2,020)
AV-742 SL30	211 (30.6)	203 (29.4)	10.4 (1,510)	13.2 (1,910)
AV-755 SL45	250 (36.2)	266 (38.6)	25.9 (3,760)	30.2 (4,380)

The test specimen for ISO test method 178 was a bar cut from an ISO 527 tensile bar measuring 80 × 10 × 4 mm (3.15 × 0.40 × 0.16 inch). The support span was 64 mm (2.52 inch) which corresponds to the specified span to depth ratio of 16:1. The testing speed used was 2 mm/min (0.08 inch/min). Only one test speed was used, thereby conforming to Method A of the standard. The flexural modulus is calculated by dividing the difference between the stress at 0.0025 strain and the stress at 0.0005 strain by 0.002 (the difference in strain from 0.0025 and 0.0005). Flexural strength is calculated from the load at break. If the sample doesn't break, the stress is calculated at 3.5 % strain.

Although the two test methods are similar in their basic approach, there are enough differences in the details that comparisons should only be made between values from the same test method.

Effect of Temperature

The flexural strength and modulus of AvaSpire® AV-621 NT and AV-621 GF30 BG20 were evaluated at elevated temperatures using ASTM test method D790. The results are compared to polyetheretherketone (PEEK) in Table 3.7 and Figures 3.25 through 3.28.

Table 3.7 Flexural properties of AvaSpire® PAEK and PEEK at elevated temperatures

Grade	Temperature [°C (°F)]			
	23 (73)	100 (212)	150 (302)	200 (392)
Flexural strength [MPa (kpsi)]				
AvaSpire® AV-621 NT	137 (19.9)	110 (15.9)	72 (10.4)	18 (2.7)
PEEK	156 (22.6)	113 (16.3)	56 (8.2)	13 (1.8)
AvaSpire® AV-621 GF30 BG20	256 (37.1)	205 (29.8)	150 (21.8)	56 (8.1)
PEEK GF30	268 (38.9)	210 (30.4)	136 (19.7)	61 (8.9)
Flexural modulus [GPa (kpsi)]				
AvaSpire® AV-621 NT	3.28 (476)	2.98 (432)	2.63 (382)	0.58 (85)
PEEK	3.76 (546)	3.44 (498)	2.35 (341)	0.32 (46)
AvaSpire® AV-621 GF30 BG20	8.96 (1300)	8.40 (1220)	7.90 (1150)	2.44 (354)
PEEK GF30	10.0 (1450)	9.33 (1350)	6.60 (958)	2.26 (328)

Figure 3.25 Flexural strength of AvaSpire® AV-621 NT and PEEK

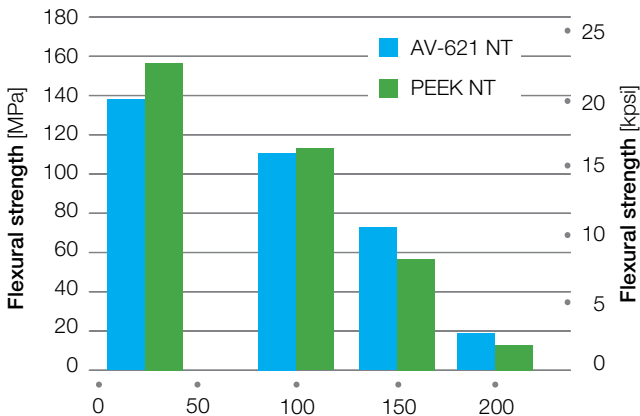
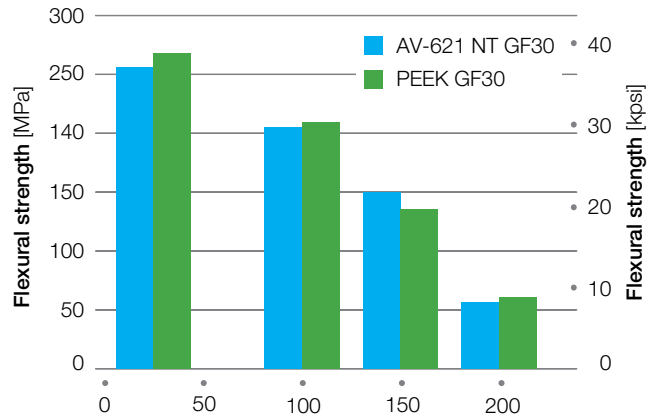

Figure 3.25 shows that the flexural strength of AvaSpire® AV-621 NT is superior to PEEK at 150 °C (302 °F).

Figure 3.26 Flexural strength of AvaSpire® AV-621 GF30 BG20 and 30 % GF PEEK



Similarly, the glass-fiber-reinforced AvaSpire® PAEK grades show a strength advantage over glass-fiber-reinforced PEEK at 150 °C (302 °F).

Figures 3.27 and 3.28 show that both neat and 30 % glass-filled grades of AvaSpire® AV-621 have a higher modulus at 150 °C (302 °F) than the corresponding PEEK grade.

Figure 3.27 Flexural modulus of AV-621 NT and PEEK

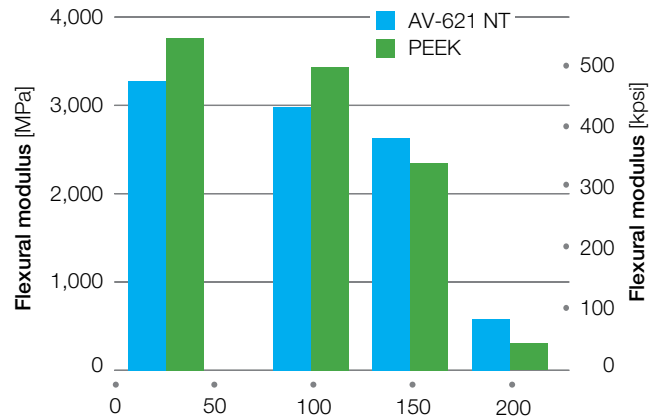
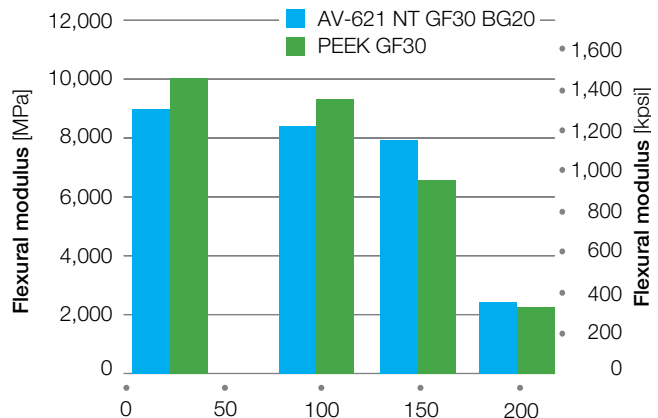

Figure 3.28 Flexural modulus of AvaSpire® AV-621 GF30 BG20 and 30 % GF PEEK



Compressive Properties

Compression testing is often considered the opposite of tensile testing. Although both involve the application of an axial load, in tensile testing the sample is pulled until it breaks, while in compression testing the sample is pushed until it breaks or buckles. A specimen with a uniform cross section is placed between parallel plates and a force applied until yield, fracture, or buckling.

Compressive Strength Testing

Compressive strength testing was done in accordance with ASTM D695 at room temperature, 100 °C (212 °F), 160 °C (302 °F), and 200 °C (392 °F). The test specimen used was an injection molded rectangular prism with dimensions of 12.7 x 12.7 x 25.4 mm (0.5 x 0.5 x 1.0 in.). Prior to testing, the specimens were annealed for two hours at 200 °C (392 °F). After annealing, they were conditioned according to ASTM D618. Testing speed was 1.3 mm/min (0.05 in./min). Stress was calculated by dividing the load by the initial cross-sectional area. The position of the crosshead was monitored and the change in position was considered nominal strain. Percent strain was calculated by dividing the measured change in crosshead position by the initial specimen height.

Load was applied until the yield point was exceeded. The yield point is defined as the first point on the stress strain diagram at which an increase in strain occurs without an increase in stress. This point is usually the maximum stress and is reported as the compressive yield strength. Ductile materials may then exhibit a plateau followed by a sharp increase in stress prior to fracture. It is important to distinguish between yield and breaking stress.

Stress-strain curves

Plots of the compressive stress versus the nominal strain for several AvaSpire® polyaryletherketone (PAEK) grades are shown in Figures 3.29 through 3.34. The compressive yield strengths of these materials at four different temperatures are shown in Table 3.8.

Figure 3.29 Stress-strain curves for AvaSpire® AV-621 NT

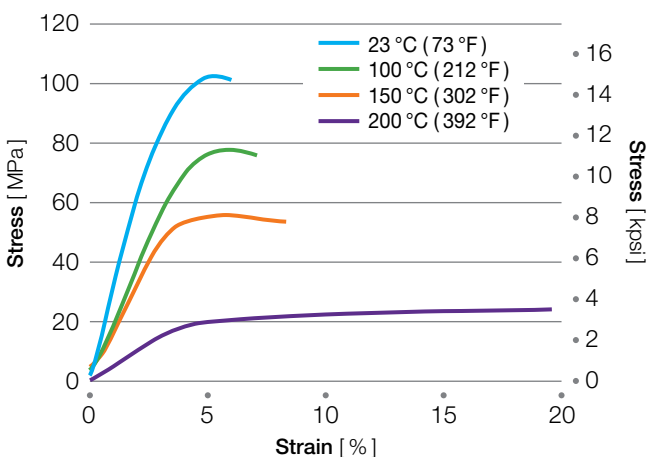

Figure 3.30 Stress-strain curves for AvaSpire® AV-621 CF30

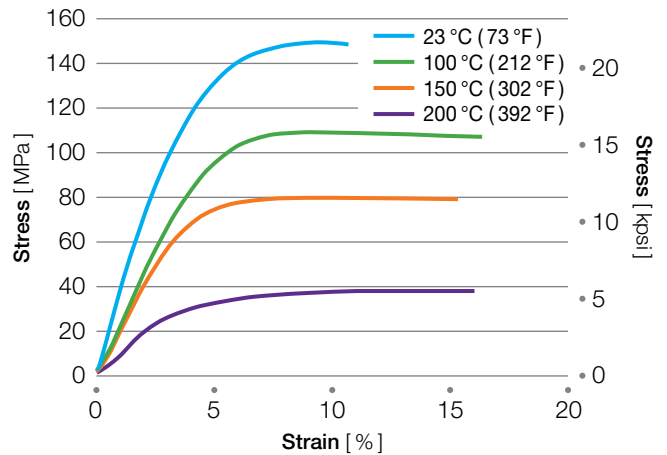

Figure 3.31 Stress-strain curves for AvaSpire® AV-722 BG20

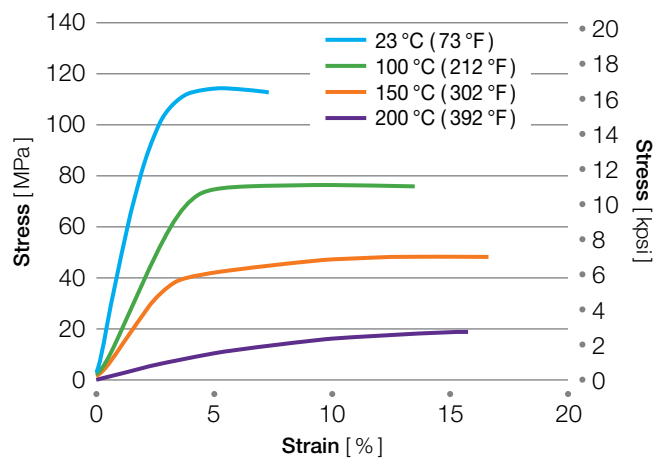

Figure 3.32 Stress-strain curves for AvaSpire® AV-722 CF30

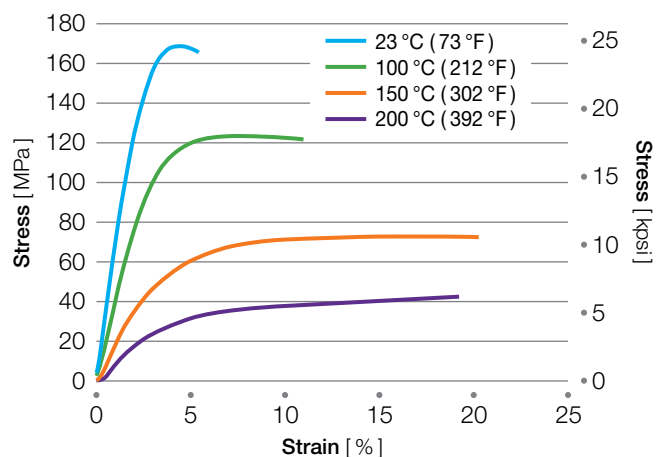

Figure 3.33 Stress-strain curves for AvaSpire® AV-722 SL30

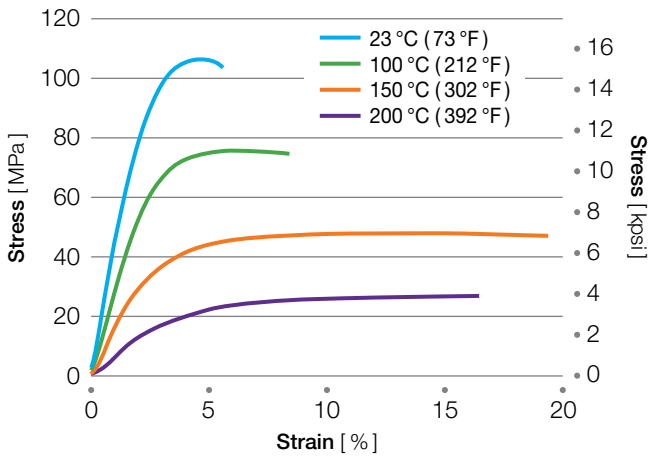

Figure 3.34 Stress-strain curves for AvaSpire® AV-742 SL30

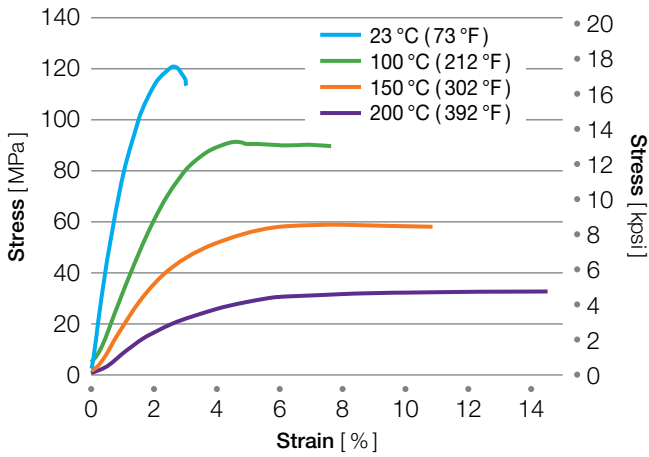

Table 3.8 Compressive yield strength of AvaSpire® PAEK at various temperatures

AvaSpire® Grade	Compressive Yield Strength [MPa (kpsi)]			
	23 °C (73 °F)	100 °C (212 °F)	150 °C (302 °F)	200 °C (392 °F)
AV-621 NT	102 (14.8)	77.7 (11.3)	55.7 (8.08)	23.9 (3.47)
AV-621 CF30	150 (21.8)	109 (15.8)	79.7 (11.6)	37.8 (5.48)
AV-722 BG20	114 (16.5)	76.6 (11.1)	48.3 (7.00)	18.7 (2.71)
AV-722 CF30	169 (24.5)	124 (18.0)	73.0 (10.6)	42.5 (6.16)
AV-722 SL30	106 (15.4)	75.8 (11.0)	47.9 (6.95)	26.8 (3.89)
AV-742 SL30	121 (17.5)	91.7 (13.3)	59.0 (8.56)	32.8 (4.76)

Compressive Modulus Testing

The compressive modulus can be used to estimate the deformation that occurs upon application of a compressive load. Compressive modulus of several AvaSpire® PAEK grades was determined using ASTM D695. The test specimen used was an injection molded rectangular prism with dimensions of 12.7 x 12.7 x 50.8 mm (0.5 x 0.5 x 2.0 in.). Prior to testing, the specimens were annealed for two hours at 200 °C (392 °F). After annealing, they were conditioned according to ASTM D618. The testing speed was 1.3 mm/min (0.05 in./min). A linear variable displacement transformer (LVDT) was attached to the top and bottom platens to more accurately measure the strain, but the quantity measured was still the motion of the platen. The test was continued until yield so the yield strength as well as the modulus were obtained. The results are shown in Table 3.9.

Table 3.9 Compressive properties of AvaSpire® PAEK

Grade	Compressive Modulus [MPa (kpsi)]	Compressive Yield Strength [MPa (kpsi)]
AV-621 NT	4,730 (686)	111 (16.2)
AV-630 NT	4,680 (679)	110 (16.0)
AV-651 BG15	4,880 (708)	112 (16.2)
AV-722 BG20	4,260 (618)	112 (16.2)
AV-621 GF30 BG20	10,040 (1,460)	159 (23.1)
AV-651 GF30 BG20	10,860 (1,580)	168 (24.4)
AV-750 GF40 NT	14,100 (2,040)	182 (26.4)
AV-621 CF30	14,500 (2,100)	152 (22.1)
AV-651 CF30	12,400 (1,800)	168 (24.4)
AV-722 CF30	15,900 (2,300)	170 (24.7)
AV-722 SL30	9,730 (1,410)	107 (15.5)
AV-742 SL30	10,000 (1,460)	121 (17.6)
AV-755 SL45	15,400 (2,240)	120 (17.4)

Shear Properties

A shear load forces the material under the load to slide past the material not under the load in the direction of the load. Shear strength is the resistance to yield or fracture of a material under a shear load. Shear strength can also be defined as the maximum load required to shear the specimen being tested in such a manner that the moving plane has completely cleared the stationary plane. Shear strength values are important in designing structural components because in actual applications the maximum stress on a component is often a shear stress.

Shear Strength Test Method

The shear strength of AvaSpire® polyaryletherketone (PAEK) was measured in accordance with ASTM test method D732. The test consists of forcing a punch through the specimen and monitoring the required load. Figure 3.35 shows a diagram of the test apparatus.

Figure 3.35 Diagram of shear test apparatus

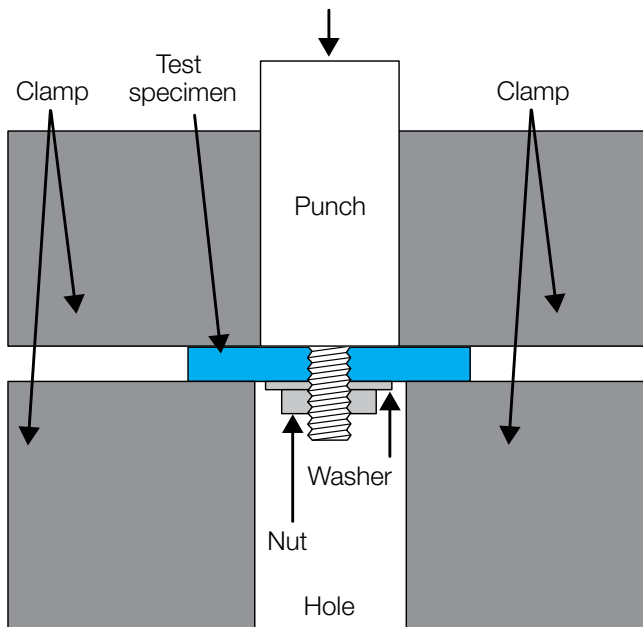

Punch diameter = 25.37 mm (0.999 in)

Hole diameter = 25.40 mm (1.000 in)

The test specimen used was an edge-gated injection-molded plaque with dimensions of 51 × 51 × 3.2 mm (2 × 2 × 0.125 inch). A hole with a diameter of 11 mm (0.43 inch) was drilled in the center. The specimen was placed over the 9.5 mm ($\frac{3}{8}$ inch) threaded pin of the punch and fastened in place with a washer and nut. The punch has an outside diameter of 25.37 mm (0.999 inch) and the hole in the fixture is 25.4 mm (1.000 inch).

The assembly of the specimen and the punch was centered on the support plate and securely clamped with four bolts to prevent any deflection or slippage when the force is applied. The entire fixture was placed in the testing machine, and the specimen was loaded at a crosshead speed of 1.25 mm (0.05 inch) per minute. The test was continued until a 25.4 mm (1.0 inch) disc was punched out of the test specimen. The maximum load was divided by the product of the circumference of the punch and the thickness of the specimen to get the maximum stress which is reported as the shear strength.

Shear Strength Values

The results of the shear strength testing are shown in Table 3.10. Fiber reinforcement increases the tensile and flexural strength dramatically but does not affect the shear strength to the same extent. The most likely reason is that the fibers are aligned in the flow direction which is perpendicular to the direction of the shear.

Table 3.10 Shear strength of AvaSpire® PAEK

Grade	Shear Strength	
	[MPa]	[kpsi]
AV-621 NT	81	11.7
AV-630 NT	79	11.5
AV-651 BG15	78	11.4
AV-722 BG20	79	11.5
AV-848 NT	82	11.9
AV-621 GF30 BG20	85	12.3
AV-651 GF30 BG20	83	12.0
AV-750 GF40 NT	89	12.9
AV-848 GF30 NT	85	12.3
AV-621 CF30	91	13.3
AV-651 CF30	94	13.7
AV-722 CF30	98	14.2
AV-848 CF30	95	13.8
AV-722 SL30	71	10.3
AV-742 SL30	70	10.1
AV-755 SL45	70	10.1

Impact Properties

Because polymers are visco-elastic, their properties depend upon the rate at which load is applied. When the loading rate is rapid, the part is said to be subjected to an impact loading.

An example of a common impact loading is a drop test, in which the plastic part is dropped from a known height onto a hard, unyielding surface, such as a concrete floor. The energy released in the collision is a function of the mass of the part and the height from which it is dropped. If the plastic part is to survive the collision without damage, it must be able to absorb this energy. Analysis and prediction of the ability of a plastic part to absorb energy is difficult because the shape, size, thickness, and the type of plastic are all variables.

Toughness as characterized by conventional test methods such as Charpy and Izod is not an intrinsic material property but rather an attribute linked to the specific sample, molded in a specified shape, possibly prepared with an initial notch and tested under specific controlled conditions. These impact resistance test methods provide values that can be helpful for determining relative impact resistance of various materials, but it is very difficult to relate these values to practical impacts or shocks met by actual parts. Suitability of a material for a particular end use must be verified by prototyping and testing of articles under actual or simulated service conditions.

Notched Izod

ASTM test method D256 details the procedure for determining the notched Izod impact resistance of plastics. Within that method, Test Method A is one of the most widely employed methods for comparing polymeric materials. In this test, a test specimen is prepared by machining in a notch with a radius of 0.25 mm (0.010 inch), a depth of 2.5 mm (0.10 inch) and an angle of 45°. The notched specimen is then struck by a swinging pendulum, as illustrated in Figure 3.36. After the impact the pendulum continues to swing, but with less energy due to the collision. The amount of energy lost is reported as the Izod impact strength in units of Joules per meter or foot-pounds per inch of beam thickness.

Figure 3.36 Notched Izod specimen

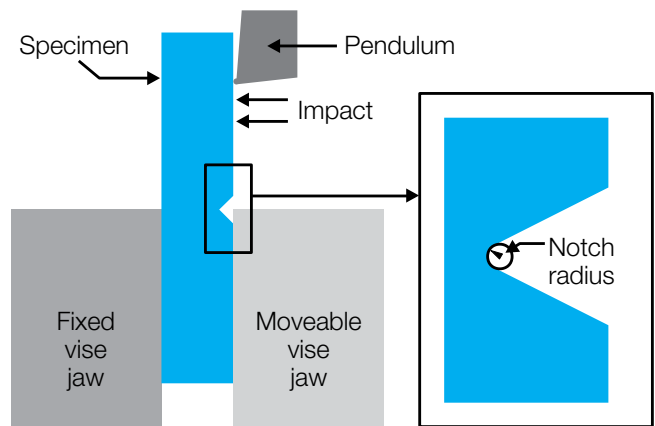

The specimen width is specified as being in the range of 3 mm to 12.7 mm (0.12 inch to 0.50 inch). Although the range of acceptable specimen width is large, the method specifies that all specimens in a group have similar nominal width, with similar defined as ± 0.13 mm (0.005 inch). The method stipulates that comparisons between materials can only be made when specimen widths are similar. The specimen width used for the data in this document was 3.2 mm (0.125 inch).

The ISO test method for this property is ISO 180. The type A notch corresponds to the notch of ASTM D256 Test Method A. The test specimen differs primarily in width and thickness. The typical ISO specimen is 4 × 10 mm (0.16 × 0.39 inch) compared to the ASTM D256 specimen which is 3.2 × 12.7 mm (0.125 × 0.50 inch). The ISO specimen thickness after notching is 8 mm (0.315 inch) versus the ASTM D256 specimen thickness after notching of 10.16 mm (0.40 inch).

The major difference between the methods, other than the test specimen, is in the way the results are calculated. The ASTM method divides the energy by the specimen width, while the ISO method divides the energy by the thickness and the width. The results by the ISO test are typically reported using units of kJ/m^2 ($\text{ft} \cdot \text{lb/in}^2$). ASTM D256 does allow an optional calculation to give units of kJ/m^2 ($\text{ft} \cdot \text{lb/in}^2$). Notched Izod impact values for AvaSpire® polyaryletherketone (PAEK), including the optional calculation, are shown in Table 3.11. One might conclude that if the optional calculation is used, ASTM and ISO data may be comparable. This is not the case as can be seen from Table 3.11.

Table 3.11 Notched Izod impact values for AvaSpire® PAEK

Grade	ASTM D256 Izod		ISO 180/A
	Usual Calculation [J/m (ft · lb/in)]	Optional Calculation [kJ/m ² (ft · lb/in ²)]	[kJ/m ² (ft · lb/in ²)]
AV-621 NT	100 (1.9)	9.8 (4.8)	7.6 (3.6)
AV-630 NT	91 (1.7)	9.0 (4.2)	7.0 (3.3)
AV-651 BG15	69 (1.3)	6.8 (3.2)	6.6 (3.1)
AV-722 BG20	80 (1.5)	7.9 (3.8)	7.0 (3.3)
AV-848 NT	75 (1.4)	7.4 (3.5)	
AV-621 GF30 BG20	123 (2.3)	12.1 (5.8)	14.3 (6.8)
AV-651 GF30 BG20	107 (2.0)	10.5 (5.0)	11.5 (5.5)
AV-750 GF40 NT	53 (1.0)	5.2 (2.5)	8.5 (4.0)
AV-848 GF30 NT	69 (1.3)	6.8 (3.2)	
AV-621 CF30	69 (1.3)	6.8 (3.2)	9.6 (4.6)
AV-651 CF30	59 (1.1)	5.8 (2.7)	8.4 (4.0)
AV-722 CF30	53 (1.0)	5.2 (2.5)	8.5 (4.0)
AV-848 CF30	43 (0.8)	4.2 (2.0)	
AV-722 SL30	69 (1.3)	6.8 (3.2)	7.4 (3.5)
AV-742 SL30	53 (1.0)	5.2 (2.5)	5.8 (2.8)
AV-755 SL45	53 (1.0)	5.2 (2.5)	6.8 (3.2)

Unnotched Izod

Failure of a material under impact conditions requires that a crack forms, and then propagates through the specimen. In the notched Izod test, the notch acts like a crack and the test is primarily measuring crack propagation resistance. When the test is run without a notch, a crack must first be formed, then propagate. Some feel that this test is better than notched Izod for predicting practical impact resistance.

The ASTM test method for unnotched Izod is D4812. It is similar to ASTM D256 except that the specimens are not notched. The ISO test method is ISO 180/U, the U indicating the absence of the notch.

Table 3.12 Unnotched Izod impact values for AvaSpire® PAEK

Grade	ASTM D4812 Izod		ISO 180/U
	Usual Calculation [J/m (ft · lb/in)]	Optional Calculation [kJ/m ² (ft · lb/in ²)]	[kJ/m ² (ft · lb/in ²)]
AV-621 NT	NB	NB	NB
AV-630 NT	NB	NB	NB
AV-651 BG15	NB	NB	NB
AV-722 BG20	NB	NB	NB
AV-848 NT	NB	NB	
AV-621 GF30 BG20	1,040 (20)	82 (40)	70 (33)
AV-651 GF30 BG20	960 (18)	76 (36)	64 (30)
AV-750 GF40 NT	590 (11)	46 (22)	41 (19)
AV-848 GF30 NT	960 (18)	76 (36)	
AV-621 CF30	640 (12)	50 (24)	39 (19)
AV-651 CF30	590 (11)	46 (22)	37 (18)
AV-722 CF30	530 (10)	42 (20)	39 (19)
AV-848 CF30	530 (10)	42 (20)	
AV-722 SL30	450 (9)	35 (18)	30 (14)
AV-742 SL30	410 (8)	32 (16)	28 (13)
AV-755 SL45	320 (6)	25 (12)	25 (12)

NB = No Break

Falling Weight Impact Tests

Another traditional method for evaluating the impact resistance of plastics involves dropping a shaped weight from various heights onto a flat plastic panel and observing the response. Two ASTM test methods for rigid plastics are D5420 and D5628. These methods vary considerably in the details, but are similar in approach. The plastic panel is impacted with an object designed to concentrate stress. The energy of the impact is controlled by the height and the mass of the impacting object. Both constant mass with variable height and constant height with variable mass approaches are represented. Also, the geometry of the falling object can be varied to evaluate the effect of stress concentration. These are practical tests that are useful for comparing materials. The primary disadvantage is that they require a large number of specimens and the results may not be as repeatable as desired.

Instrumented Impact Testing

Adding load and displacement sensors to the falling weight impact test allows for the quantification of the loads and energy required to cause impact failures. ASTM test method D3763 details this method. The equipment for running this test and the test itself is commonly referred to as Dynatup® (registered trademark of Instron Corporation) although other companies now manufacture similar equipment.

The impact resistance of several grades of AvaSpire® PAEK was evaluated according to ASTM D3763. The test specimens used were plaques having dimensions of 102 × 102 × 3.2 mm (4 × 4 × 0.125 inch). The specimens were clamped securely and impacted with a plunger having a hemispherical end with a diameter of 12.7 mm (0.5 inch). The test speed was set to 146 m/min (8 ft/s). The maximum load, energy at maximum load, and the total energy were recorded. Typical values for this material are shown in Table 3.13.

Table 3.13 Puncture properties (Dynatup®) of AvaSpire® PAEK

Grade	Maximum Load [N (lbf)]	Energy at Maximum Load [J (ft · lb)]	Total Energy [J (ft · lb)]
AV-651 NT BG15	6,160 (1,385)	52.9 (39)	61.0 (45)
AV-651 GF30 BG20	1,440 (324)	8.95 (6.6)	11.1 (8.2)

Long-Term Mechanical Properties

Creep Properties

When designing an engineered component to be fabricated from AvaSpire® polyaryletherketone (PAEK), the designer needs to consider the long-term effects of stress and environmental factors along with short-term mechanical properties. If a component will be subjected to sustained stress, then creep must be considered. If the application of stress is cyclical, then fatigue must also be considered.

Creep

When a material is subjected to stress, an immediate strain occurs. For small strains, this strain is proportional to the stress and calculable from the appropriate modulus. If the application of stress continues for an extended period of time, additional strain may be observed. This behavior is referred to as creep and the additional strain as creep strain.

While creep is observed in metals, the phenomenon is more prominent with plastics. Their lower modulus means that at the same stress level, the magnitude of the strain is larger and there is a higher proportion of ultimate strain. In general, the closer the initial strain is to the ultimate strain, the more likely it is that creep will be significant.

When designing for a sustained load, the apparent creep modulus should be used for calculating deformations rather than the elastic modulus. Because of the viscoelastic nature of polymeric materials, the manner in which the stress is applied affects the amount of strain and therefore the modulus.

In general, metals will have a single elastic modulus which is used for all calculations. However, polymeric materials will have a tensile modulus, a compressive modulus, and a flexural modulus. The designer must evaluate how the stress is applied and choose the appropriate modulus for his calculations. In addition, the modulus will vary somewhat with strain rate; therefore, when comparing materials, the strain rates should be the same.

Ideally, creep would be evaluated in both tensile and compressive modes. The data provided in this document were generated in the tensile mode according to ASTM D2990. The test specimens used were ASTM D638 Type 1 tensile bars. Prior to testing all samples were annealed for 2 hours at 200 °C (392 °F) and then conditioned per ASTM D618. Stress was applied using the appropriate amount of static weight. Strain was measured with an electromechanical extensometer for the samples tested at 23 °C (73 °F) and 120 °C (248 °F). For the tests at 160 °C (320 °F) and 200 °C (392 °F), the strain was measured using a contactless videoextensometry technique.

Isochronous curves

To measure creep, test specimens are subjected to several stress levels at several temperatures and the strain is monitored over time. A large amount of data is generated which can be displayed in several different ways. One of the most compact methods is the use of isochronous curves. To generate an isochronous curve, the stress is plotted against the strain measured at a selected time interval. The isochronous curves in this document can be used to estimate the amount of elongation or strain resulting from application of a load or stress for 1,000 hours.

For example, consider AvaSpire® AV-621 GF30 subjected to a stress of 80 MPa (11.6 kpsi) at room temperature. From the tensile modulus of 9,900 MPa (1,430 kpsi) and the stress of 80 MPa (11.6 kpsi), the immediate strain is estimated to be approximately 0.81 %. From Figure 4.1, a stress of 80 MPa (11.6 kpsi) sustained for 1,000 hours produces a strain of about 1.01 %. Therefore, the additional strain due to creep is estimated to be 0.2 %.

Another way to estimate this strain is to use the apparent modulus vs. time graph for this grade (Figure 4.7). At 1,000 hours, the apparent modulus is approximately 7,500 MPa (1,088 kpsi). Dividing 80 MPa (11.6 kpsi) by 7,500 MPa (1,088 kpsi) gives a strain of about 1.06 %.

The modulus of AvaSpire® PAEK, like all polymeric materials, is reduced when the temperature is raised. The lower modulus results in a greater immediate strain at the same stress. The effect of elevated temperature on creep strain is shown in Figures 4.2 through 4.4.

Figure 4.1 Isochronous curves at 23 °C (73 °F)

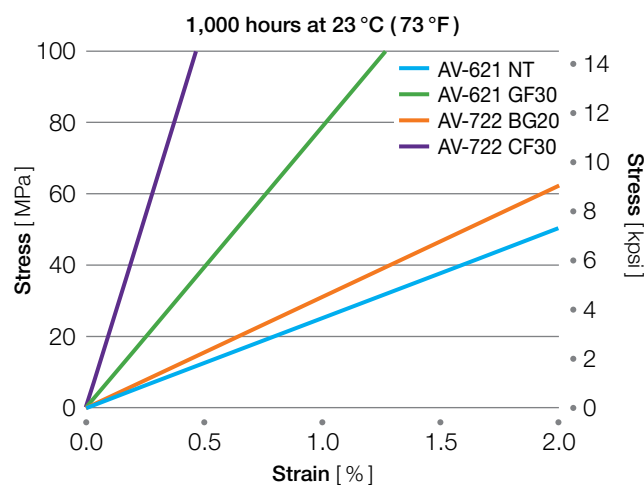

Figure 4.2 Isochronous curves at 120 °C (248 °F)

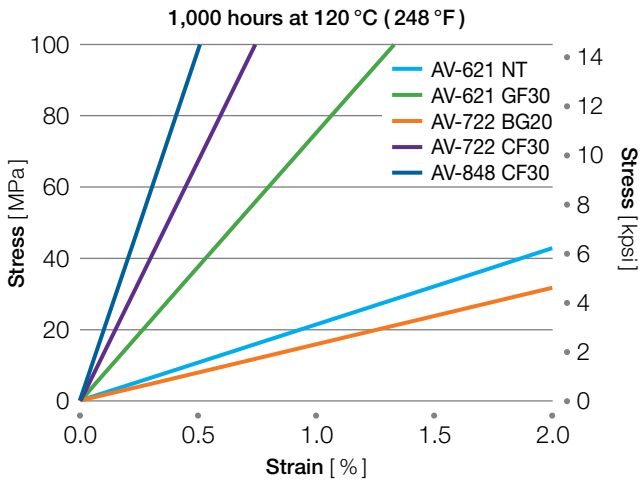

Figure 4.3 Isochronous curves at 160 °C (320 °F)

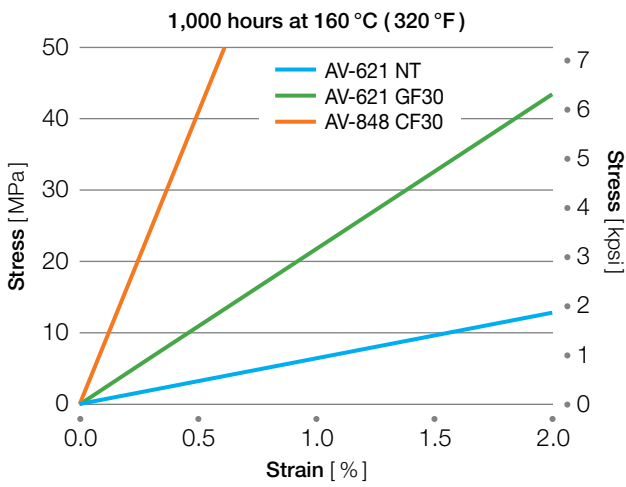
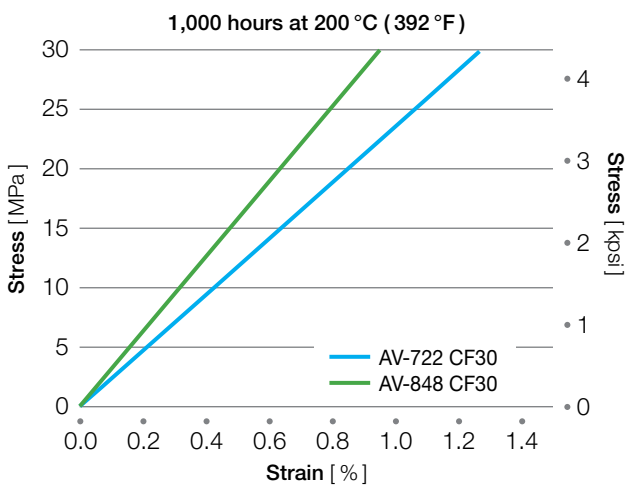

Figure 4.4 Isochronous curves at 200 °C (392 °F)



Apparent or Creep Modulus Graphs

Selected AvaSpire® PAEK grades were tested at multiple stress levels at varying temperatures. From the observed strain, the apparent modulus was calculated and plotted against the time the stress was applied. Creep strain can be estimated from the apparent modulus for the stress level, temperature, and time for the material under consideration. The results are shown in Figures 4.5 through 4.18.

All testing was done on tensile bars with loads in tension. When designing components for sustained load, prototype testing is highly recommended because the effects of stress concentrations and loading modes are difficult to predict.

Figure 4.5 AV-621 NT at 23 °C (73 °F)

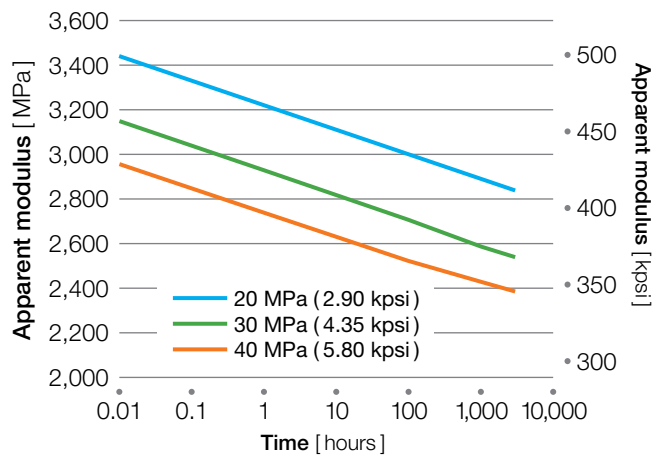

Figure 4.6 AV-722 BG20 at 23 °C (73 °F)

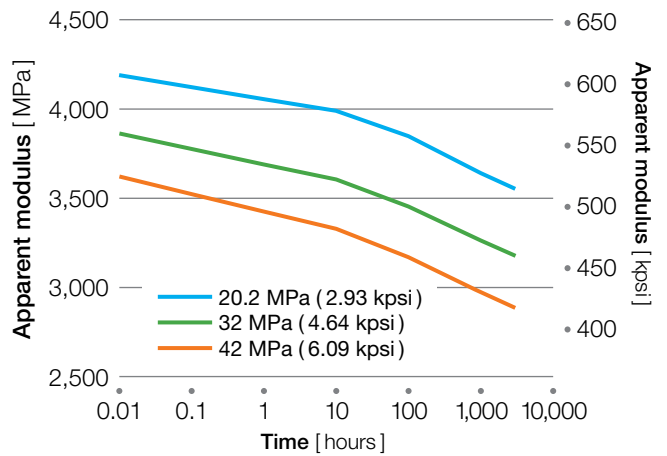

Figure 4.7 AV-621 GF30 at 23 °C (73 °F)

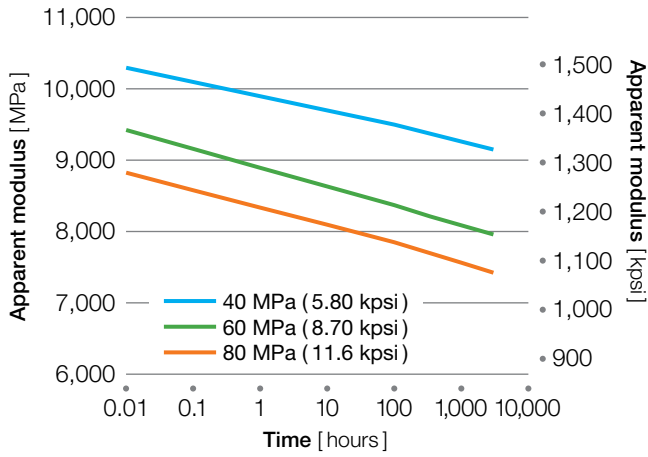

Figure 4.10 AV-722 BG20 at 120 °C (248 °F)

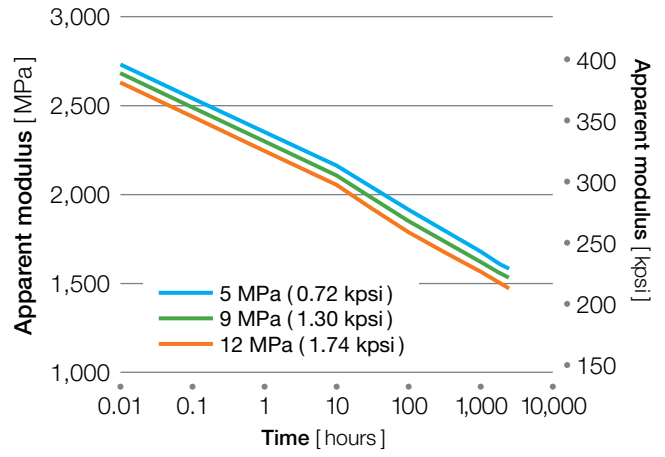

Figure 4.8 AV-722 CF30 at 23 °C (73 °F)

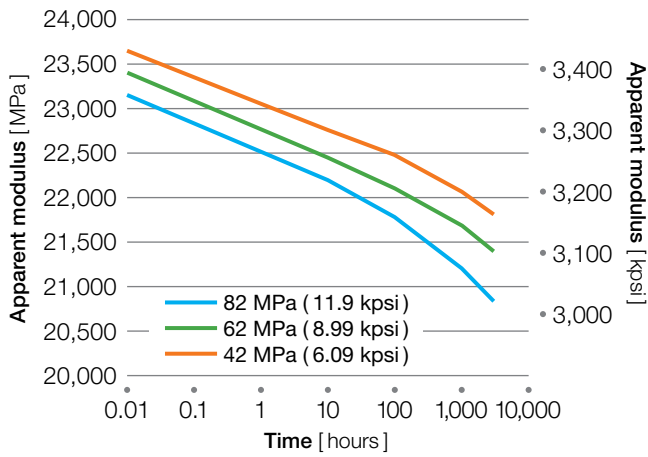

Figure 4.11 AV-621 GF30 at 120 °C (248 °F)

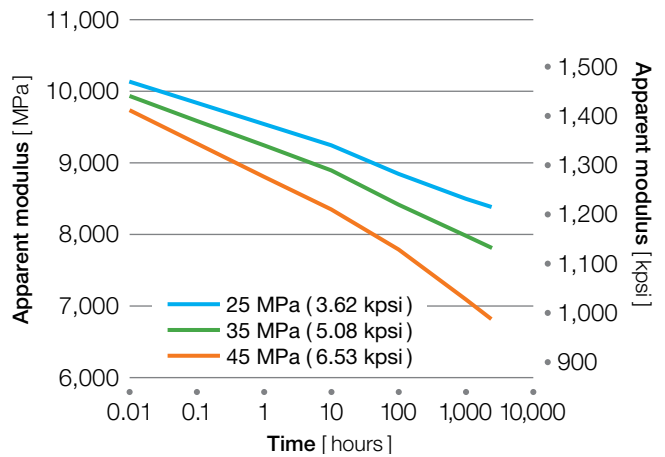

Figure 4.9 AV-621 NT at 120 °C (248 °F)

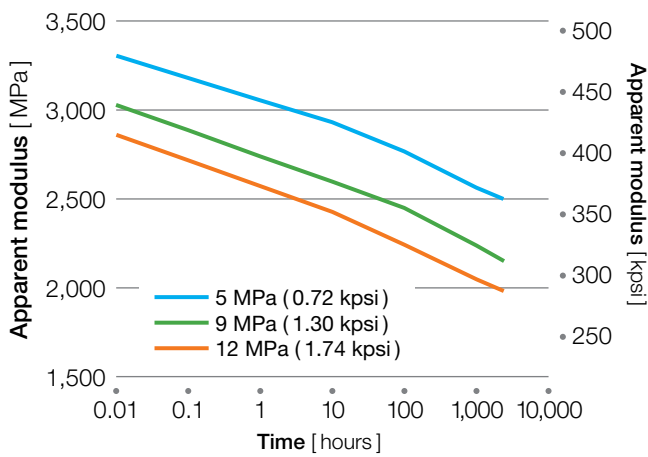

Figure 4.12 AV-722 CF30 at 120 °C (248 °F)

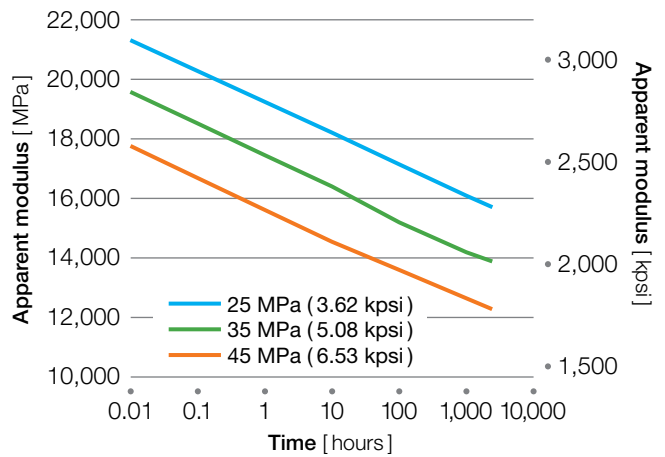

Figure 4.13 AV-848 CF30 at 120 °C (248 °F)

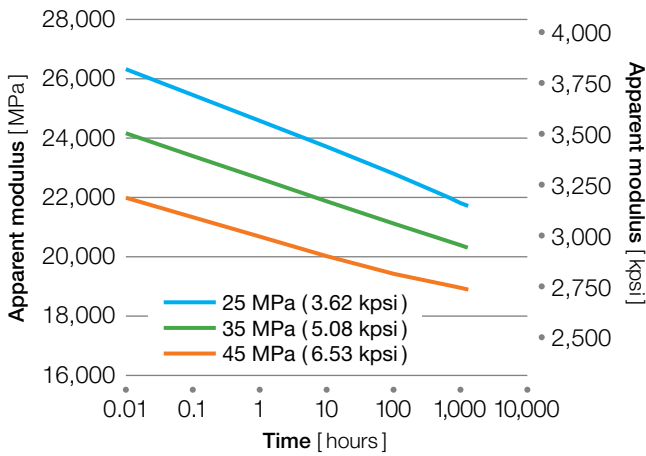

Figure 4.16 AV-848 CF30 at 160 °C (320 °F)

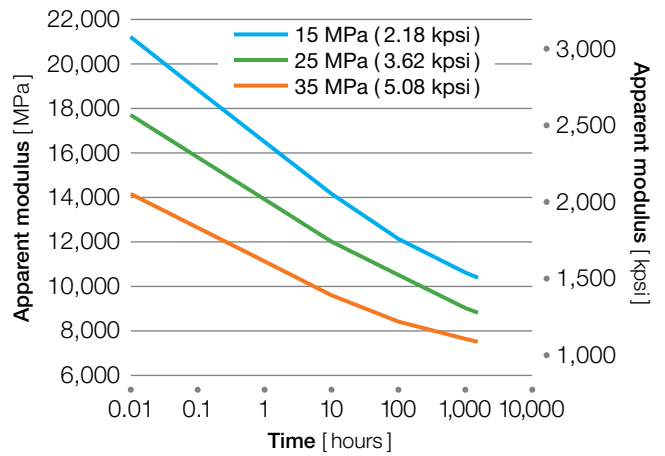

Figure 4.14 AV-621 NT at 160 °C (320 °F)

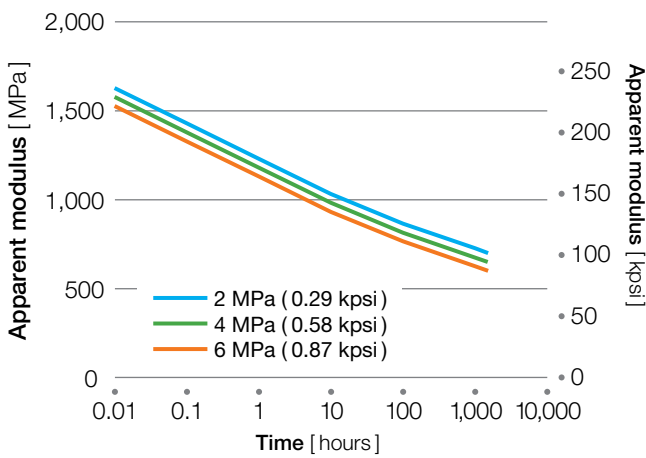

Figure 4.17 AV-722 CF30 at 200 °C (392 °F)

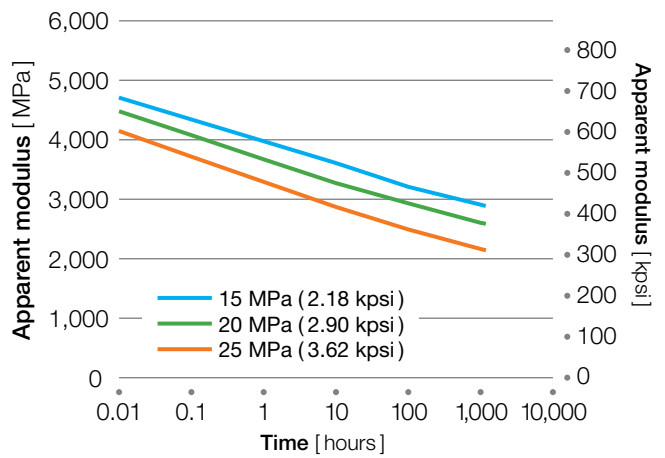

Figure 4.15 AV-621 GF30 at 160 °C (320 °F)

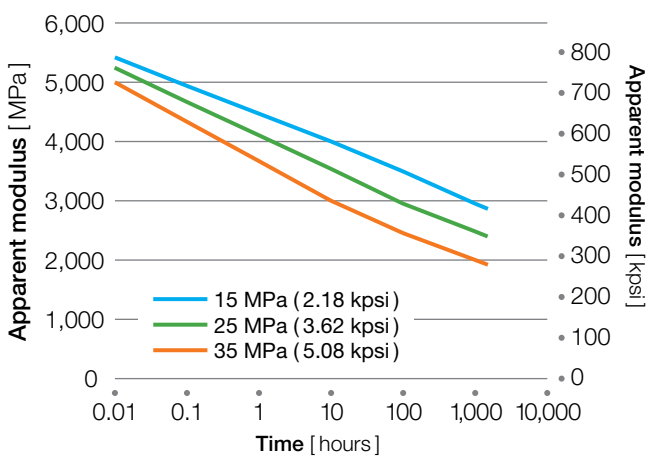
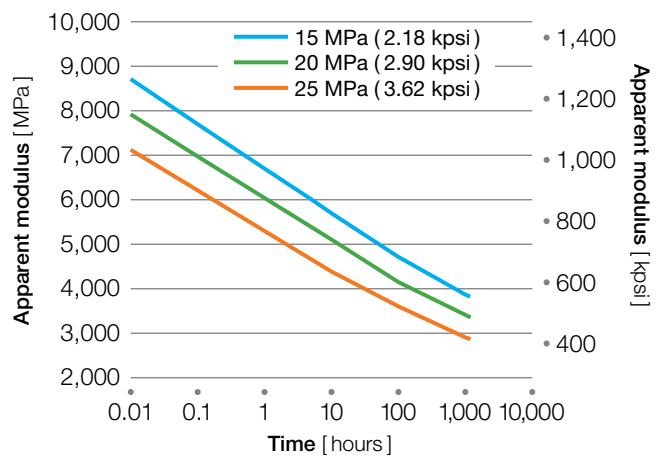

Figure 4.18 AV-848 CF30 at 200 °C (392 °F)



Fatigue Properties

When an object is stressed cyclically, failure or rupture will typically occur at stress levels lower than its short-term ultimate strength. Repeated loading and unloading causes progressive and localized structural damage to the object until failure occurs. This failure is commonly called a fatigue failure.

Fatigue strength (SN) is commonly defined as the stress that will rupture after N cycles. Fatigue data are commonly presented in S-N diagrams or curves where the maximum applied stress is plotted against the log of the number of cycles to rupture.

Only a few metals appear to be able to tolerate certain levels of cyclic stress for an infinite number of cycles without rupture. This stress level is called the fatigue limit or endurance limit of that material. For most other materials, including many metals, rupture will occur at a finite number of cycles even for small stresses. The accepted practice is to consider the stress that can be tolerated for 10^7 cycles as the practical fatigue limit. There is a wide variation in testing modality that affects these values. Comparisons of fatigue properties should be done only when comparable test methods are used.

While test specimens, test frequency, loading mode and environmental conditions all influence fatigue strength, the fatigue limit will always be less than the material's ultimate strength. To provide a frame of reference, most steels have a fatigue limit of about 50 % of their ultimate tensile strength, while the fatigue limit of aluminum and copper is about 40 % of their ultimate tensile strength or less. Design engineers converting a metal component into plastic need to evaluate the application for the possibility of cyclic loading and consider fatigue limit when appropriate.

Design Considerations

A good example of an application involving cyclic stress is a gear. As the driving gear rotates and causes the driven gear to rotate, each tooth in turn is subjected to stress, followed by a period of low or zero stress until that tooth is engaged again. Many applications have a fatigue aspect where the cyclic loading is not as evident. Other examples are bushings that guide a rotating shaft, parts subject to vibration, and any part in a reciprocating pump or compressor.

When designing a component that will be subjected to cyclic loading, the establishment of fatigue strength requirements is desirable. However, analysis of the fatigue strength requirements is complicated by a large number of factors, including:

- Shape of the component
- Stress concentration factors
- Rate of load application
- Temperature change caused by load application
- Type of stress induced by load (tensile, compressive or shear)
- Environmental factors (chemicals, radiation and temperature)
- Residual stresses
- Duty cycle
- Desired life of the component

The use of CAE tools can assist in determining the effective stress resulting from a specified load, which can then be compared to the S-N curve to estimate product fatigue life.

Fatigue Testing

There is no single, widely-accepted method for determining fatigue strength or fatigue limit. Published data on the fatigue strength of various materials includes values obtained in tensile, compressive, and flexural modes. Other important variables are the frequency/cycles per second, the loading pattern or waveform, the ratio of maximum stress to minimum stress or R value, and the temperature.

Later in this document, the effects of fiber orientation and heat history on the mechanical properties of a material are discussed. These effects also apply to the specimens used for fatigue testing and must be considered.

Failure in a fatigue test is the result of progressive, localized damage where micro-cracks form, and then grow with continued cycling until rupture finally occurs. Crack formation and propagation are highly dependent on specimen morphology and cause variability in the number of cycles to failure.

Typically, stresses close to the ultimate strength are run first because failure usually occurs in a short time. Subsequent samples are run at lower and lower stress levels and several specimens are run at each stress level. Often, time constraints will result in test termination prior to rupture. These points, called runouts, are useful as they provide a minimum stress value for a number of cycles. The fatigue limit is estimated by plotting a large number of stresses and the resultant numbers of cycles to failure on a semi-log S-N diagram.

Testing AvaSpire® PAEK

In this section, specific testing programs on various grades of AvaSpire® polyaryletherketone (PAEK) are presented. This information is by no means exhaustive. Please contact your Solvay representative to discuss your specific needs.

Tensile fatigue of AvaSpire® PAEK at 23 °C (73 °F)

Three grades of AvaSpire® PAEK, AV-621 NT, AV-722 BG20, and AV-722 CF30 were injection molded into tensile bars conforming to the dimensional requirements of ASTM D638 Type 1. The bars were annealed for 2 hours at 200 °C (392 °F), and then conditioned according to ASTM D618. The specimens were loaded cyclically in the tensile mode using a sinusoidal loading pattern. The specified test stress was the peak stress.

The low stress was 10 % of the peak stress ($R = 0.1$). The test frequency was 2 Hz, which was low enough to avoid self-heating of the specimen. Several specimens were tested at each stress level and the number of cycles to failure was recorded. To facilitate interpretation, trend lines were extrapolated for each material based on the experimental points. The resulting trend lines are summarized in Figure 4.19.

Figure 4.19 Tensile fatigue of AvaSpire® PAEK at 23 °C (73 °F)

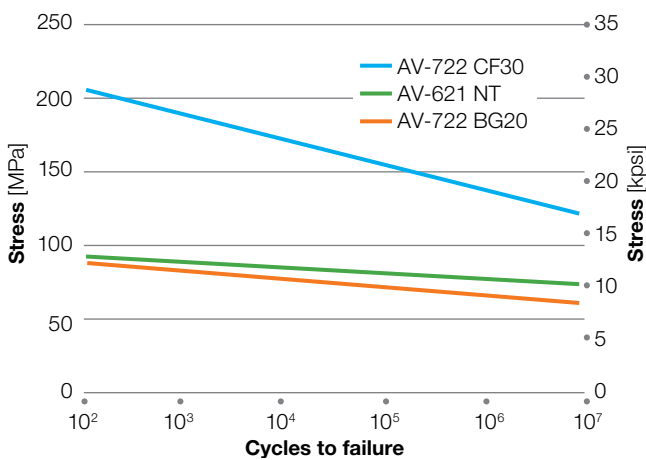

Tensile fatigue of glass fiber reinforced AvaSpire® PAEK at 160 °C (320 °F)

AvaSpire® AV-621 GF30 BG20 was molded into specimens conforming to ASTM D638 Type 1 bars. The bars were annealed for 2 hours at 200 °C (392 °F), and then conditioned according to ASTM D618. The specimens were loaded cyclically in a tension-tension mode using a sinusoidal loading pattern. The specified test stress was the peak stress. The low stress was 10 % of the peak stress ($R = 0.1$). The test frequency was 1 Hz. Several specimens were tested at each stress level and the number of cycles to failure was recorded. To facilitate interpretation, trend lines were extrapolated for each material based on the experimental points. The resulting trend lines are summarized in Figure 4.20.

Figure 4.20 Tensile fatigue of AvaSpire® AV-621 GF30 BG20 at 160 °C (320 °F)

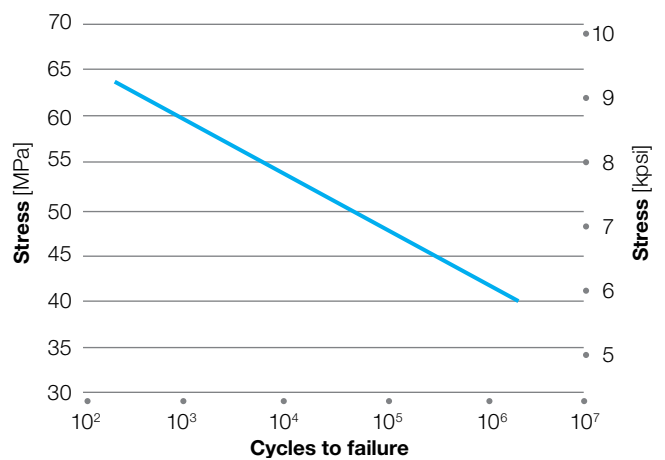

Temperature Effects

Thermal Properties

Thermal properties encompass all of the changes that occur as a result of the temperature of a material being changed. In this document, the dimensional changes (CLTE), the deflection under load (HDT), the transition temperatures (T_g and T_m), thermal conductivity, and specific heat capacity of AvaSpire® polyaryletherketone (PAEK) will be discussed.

The mechanical property changes are discussed in the Mechanical Properties document. Long-term exposure to elevated temperatures is discussed in the Thermal Stability document. The changes in crystallinity are discussed in the Crystallinity and Annealing document. The properties of the molten polymer are discussed in the processing documents.

Linear Thermal Expansion

Most objects will get larger as they absorb heat and increase in temperature. The amount of dimensional change depends on the nature of the material and the temperature range. Thermal expansion can be characterized either by measuring the change in volume or by measuring the change in one linear dimension. The volume expansion gives the pressure-volume-temperature (PVT) diagram while the linear expansion test provides the linear thermal expansion coefficient (CLTE).

When assemblies are created using materials with different thermal expansion coefficients, stresses can occur when the temperature of the assembly is changed. If the assembly will be subjected to repeated thermal cycling, fatigue may need to be considered. Large differences in thermal expansion can also affect the fit of mating parts with tight dimensional tolerances and the adhesion of coatings when the assemblies are exposed to a broad temperature range.

Definition

The coefficient of linear thermal expansion (α or CLTE) is the ratio of the change in length to the change in temperature as shown in Figure 5.1. It is a measurement of the rate of expansion of a solid mass as its temperature is increased. If the coefficient α is known, the change in length of an unrestrained straight bar raised to a temperature T_F can be calculated from:

$$\Delta L = \alpha L (T_F - T_o)$$

Where:

ΔL = Change in length

L = Original length

α = Coefficient of linear thermal expansion (CLTE)

T_F = Final temperature

T_o = Initial temperature

Figure 5.1 Calculation of coefficient of linear thermal expansion

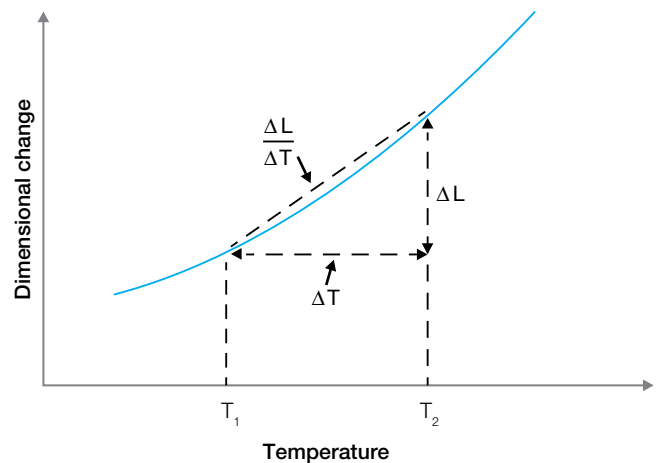

Measurement

Determining the thermal expansion coefficient requires precise measurement of a linear dimension while changing the temperature of the specimen. One common method uses a vitreous silica rod and tube. The specimen is placed in the tube, the rod is added and attached to a gauge. This technique is called dilatometry and is the basis for ASTM test methods D696 and E228. A newer method uses an instrument called a Thermomechanical Analyzer. In this instrument a probe in contact with the specimen is attached to a linear motion sensor which measures the dimensional change. ASTM test method E831 and ISO test method 11359 cover the use of a thermomechanical analyzer (TMA) to determine the coefficient of linear thermal expansion.

The data reported in this document were generated according to ASTM E831 using test specimens cut from injection molded tensile bars approximately $12 \times 12 \times 3$ mm ($0.5 \times 0.5 \times 0.12$ inch) as shown in Figure 5.2. The orientation of the test specimen was noted so that the expansion in the direction of material flow could be compared to the expansion transverse to the direction of material flow.

The output from the TMA is dimensional change and temperature data. When the data is plotted, a graph similar to Figure 5.3 is obtained. This plot shows two runs: one with the specimen oriented in the flow direction and a second with another specimen oriented in the transverse direction.

As shown in Figure 5.1, the coefficient of linear thermal expansion (CLTE) is the slope of the dimensional change versus temperature line over a temperature range. For this illustration, the CLTE was calculated over several ranges as shown in Table 5.1.

The data in Table 5.1 illustrate several concepts. The CLTE can be calculated over any temperature range desired to visualize the change in CLTE with temperature. CLTE was calculated at smaller temperature ranges than usual. The CLTE changes with temperature, gradually increasing until around 150 °C (302 °F) where it increases rapidly. This rapid change indicates that the glass transition temperature (T_g) of the polymer has been reached. This is an unreinforced grade and the CLTE in the flow direction is quite similar to the CLTE in the transverse to flow direction.

The addition of reinforcing fibers to a polymer causes a significant change in the CLTE. The fibers will expand less than the polymer when heated. Also, the fibers tend to become oriented in the flow direction when the samples are molded. Figure 5.4 shows the dimensional change versus temperature plot for a grade containing 30 % glass fiber reinforcement, AV-621 GF30, in both the flow and transverse direction.

Table 5.1 CLTE of AvaSpire® AV-621 NT

Temp 1 [°C (°F)]	Temp 2 [°C (°F)]	CLTE Flow [$\mu\text{m}/\text{m } ^\circ\text{C}$ ($\mu\text{in}/\text{inch } ^\circ\text{F}$)]	CLTE Trans. [$\mu\text{m}/\text{m } ^\circ\text{C}$ ($\mu\text{in}/\text{inch } ^\circ\text{F}$)]
25 (77)	50 (122)	45 (25)	55 (31)
50 (122)	100 (212)	51 (28)	60 (33)
100 (212)	150 (302)	54 (30)	63 (35)
150 (302)	200 (392)	86 (48)	110 (61)

Figure 5.2 CLTE specimen

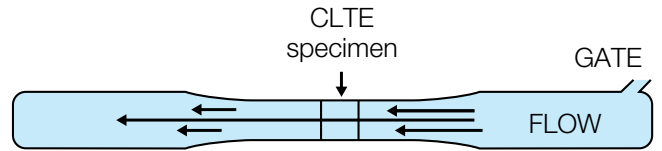

Figure 5.3 CLTE for AvaSpire® AV-621 NT

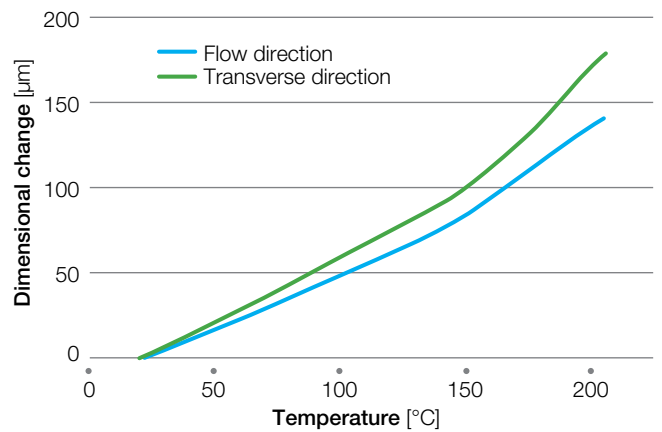
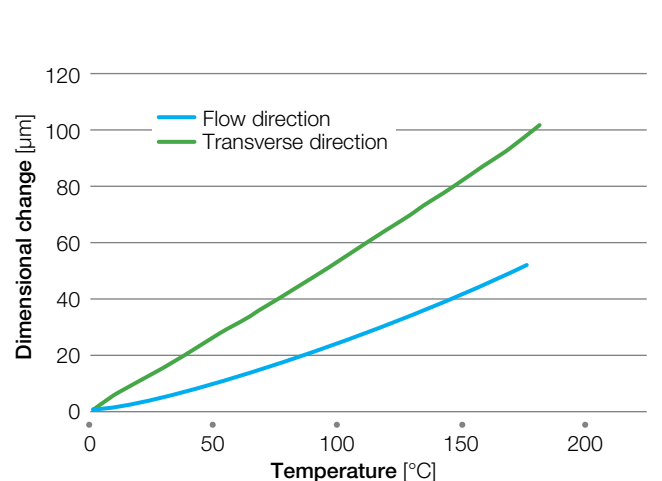

Figure 5.4 CLTE of AvaSpire® AV-621 GF30



In the flow direction, the thermal expansion is constrained by the fiber. In the transverse direction, the thermal expansion is very similar to unreinforced polymer. In actual molded articles, it would be unusual to see this high degree of fiber orientation. Micromechanics can be used to determine the CLTE along any direction if the fiber orientation is known by measurement or prediction. Refer to the Design Principles document for a discussion of micromechanics. For practical purposes, a CLTE between these extremes is more likely.

CLTE Results

The coefficients of linear thermal expansion (α), as measured by ASTM E831, of various AvaSpire® PAEK grades and some common metals are given in Table 5.2. These values were determined using the standard test specimens described earlier that had been annealed for 2 hours at 200 °C (392 °F).

As shown in Figure 5.1, the CLTE is calculated by taking the slope of the dimensional change versus temperature curve. The CLTE can be calculated over several temperature ranges and it does vary with temperature. Table 5.2 presents data at five temperature ranges

extending from sub-ambient to above the T_g of the resin. This allows the user to choose a value near the temperature range expected in service.

Design Implications

These values are most useful for comparing materials prepared and tested by the same procedures. Few actual applications will be fabricated such that the orientation of reinforcing fillers will be purely in the flow or transverse directions. Most molded parts will contain regions where the polymer is oriented in the flow direction and other regions where transverse orientation dominates. The resultant amount of thermal expansion will most likely lie between the values listed in the table. Clearances and tolerances must take into account the expansion at temperature.

When designing assemblies, the values in Table 5.2 can aid in material selection. If the assembly consists of materials with different CLTE's, the design engineer may use these values in a FEA calculation to estimate the thermal stresses likely to occur in service. Prototype testing under actual or simulated service conditions is recommended.

Table 5.2 Coefficients of linear thermal expansion

Temperature Ranges	- 50 to 0 °C (- 58 to 32 °F)		0 to 50 °C (32 to 122 °F)		50 to 100 °C (122 to 212 °F)		100 to 150 °C (212 to 302 °F)		150 to 200 °C (302 to 392 °F)	
	Flow	Transverse	Flow	Transverse	Flow	Transverse	Flow	Transverse	Flow	Transverse
Unreinforced resins										
AV-621 NT					51 (28)	60 (33)	54 (30)	63 (35)	86 (48)	110 (61)
AV-651 BG20	45 (25)	48 (27)	49 (27)	50 (28)	54 (30)	55 (31)	59 (33)	54 (30)	101 (56)	83 (46)
AV-722 BG20			45 (25)	60 (33)	50 (28)	61 (34)	69 (38)	87 (48)		
AV-848 NT	39 (22)	41 (23)	44 (24)	48 (27)	46 (26)	51 (28)	48 (27)	55 (31)	63 (35)	81 (45)
Glass fiber reinforced resins										
AV-621 GF30 BG20	18 (10)	48 (27)	17 (9)	46 (26)	27 (15)	50 (28)	34 (19)	52 (29)		
AV-651 GF30 BG20	17 (9)	45 (25)	18 (10)	47 (26)	19 (11)	53 (19)	20 (11)	57 (32)	13 (7)	88 (49)
AV-750 GF40	14 (8)	39 (22)	16 (9)	41 (23)	19 (11)	51 (28)	21 (12)	69 (38)	15 (8)	100 (56)
AV-848 GF30	15 (8)	39 (22)	16 (9)	46 (26)	16 (9)	50 (28)	17 (9)	53 (29)	16 (9)	82 (46)
Carbon fiber reinforced resins										
AV-621 CF30	5 (3)	50 (28)	5 (3)	52 (29)	5 (3)	56 (31)	4 (2)	66 (37)		
AV-651 CF30	8 (4)	41 (23)	6 (3)	43 (24)	6 (3)	46 (26)		56 (31)		
AV-722 CF30	6 (3)	49 (27)	6 (3)	50 (28)	7 (4)	60 (33)	11 (6)	94 (52)		
Wear-resistant grades										
AV-722 SL10	13 (7)	12 (7)	12 (7)	10 (6)	12 (7)	5 (3)				
AV-742 SL30	12 (7)	44 (24)	10 (6)	46 (26)	10 (6)	52 (29)	7 (4)	73 (41)		
AV-755 SL45					5 (3)	40 (22)			5 (3)	99 (55)
Common metals (literature data for comparison)										
Zinc alloy						27 (15)				
Aluminum alloy A-360						21 (12)				
Stainless steel						17 (9)				
Carbon steel						11 (6)				

Values are 10^{-6} L/L per °C (10^{-6} L/L per °F) where L = Length

Comparing CLTE Values from Different Sources

The test methods and test specimen geometries affect the CLTE values; therefore, only values from the same test method and test specimen geometry are comparable. This section discusses the reasons for variability due to test method and test specimen.

Test method

Dilatometry and TMA measurements often will differ due to the inherent differences in methodology. There are two TMA test methods: ASTM E831 and ISO 11359-2. ASTM E831 states that ISO 11359-2 is related, but is significantly different in technical detail. This comment suggests that ASTM E831 results cannot be directly compared to ISO 11359-2 results.

This analysis requires precise measurement of very small dimensional changes as well as precise temperature measurements. The thermocouple measuring the specimen temperature is close to, but not in contact with, the specimen. This results in a small difference that can be affected by the heating and cooling rates. This difference can become more important if specimens of different thickness are being compared.

Part thickness

Thermal expansion occurs in all directions and therefore specimens of different thicknesses will not give the same results when measured in the length or width direction. Also, heat flow and temperature gradients across thick parts can inflate or deflate CLTE values.

Temperature range and phase changes

The thermal expansion behavior of metals is typically uniform over the service temperature range. However, the behavior of polymeric materials varies with temperature as shown in Figure 5.3. Polymeric materials expand more above their glass transition temperature (T_g) than below it. Amorphous plastics generally show little variation in CLTE with flow direction, but semi-crystalline materials tend to expand somewhat less in the flow direction than in the transverse, or across flow, direction. The difference is small.

As shown earlier, the CLTE value depends upon the temperature range selected for the calculation. ASTM test method E831 does not specify the temperature range to be used. When comparing values from different sources, make sure the temperature ranges are similar.

Processing parameters

Molding or extrusion conditions can influence crystallinity which can affect the measured coefficient of thermal expansion. Mold temperature and cooling rates are the parameters likely to have the greatest affect.

Reinforcements

Glass fibers, carbon fibers, and other reinforcing fillers with positive aspect ratios impart anisotropy in the thermal expansion coefficients. Because fibers often orient in the flow direction, and glass and carbon fiber reinforcements have a lower thermal expansion coefficient than polymers, the coefficient of expansion is generally lower in the flow direction than the transverse direction. Figure 5.4 shows the CLTE of a 30 % carbon-fiber reinforced grade. Of course, no practical part will be exclusively flow or transverse.

Deflection Temperature Under Load (HDT)

The deflection temperature under load predicts the practical thermal limit for a material. The most commonly used test method is ASTM D648. A bar with a rectangular cross section is placed edgewise on two supports. A load is applied to the center, and the temperature is increased until the bar deflects a specified amount. The temperature at which the deflection occurs is the deflection temperature or the HDT.

ASTM D648 specifies a test specimen 127 mm (5.0 inch) long, 13 mm (0.5 inch) high, and the width can range from 3 to 13 mm (0.125 inch to 0.5 inch). The bar is placed on supports either 101.6 mm (4.0 inch) apart for Method A or 100.0 mm (3.94 inch) apart for Method B. The bar is loaded with weights to give an outer fiber stress of either 0.45 MPa (66 psi) or 1.8 MPa (264 psi). The assembly is lowered into a fluid bath and the deflection gauge is set to zero. The temperature of the fluid is then increased at a uniform rate of 2 °C/min (3.6 °F/min). The vertical deflection is monitored until it reaches the specified end point of 0.25 mm (0.010 inch). The temperature is noted and reported as the heat deflection temperature, or HDT.

The ISO 75 test method part 1 and 2 is different from ASTM D648 in several important aspects but gives similar results. The test specimen is a bar with rectangular cross section with the dimensions 80 × 10 × 4 mm (3.15 × 0.39 × 0.157 inch). The bar can be made from the center portion of an ISO 527 tensile bar. The bar is tested in the flatwise orientation rather than the edgewise orientation of D648. The distance between the supports is 64 mm (2.52 inch). The same outer fiber stresses of either 1.8 MPa or 0.45 MPa are specified. This method also includes a higher outer fiber stress of 8 MPa (1,160 psi). All of the data in this document was collected using 1.8 MPa (264 psi). The endpoint deflection is calculated from the specimen thickness and is 0.34 mm (0.013 inch) for a 4 mm (0.16 inch) bar. With all of these differences, ISO 75 results are usually quite similar to ASTM D648 results.

Table 5.3 Heat deflection, glass transition and melting temperatures for AvaSpire® PAEK

Grade	Heat Deflection Temperature [°C (°F)]	Glass Transition Temperature T _g [°C (°F)]	Melting Temperature T _m [°C (°F)]
AV-621 NT	187 (369)	158 (316)	340 (644)
AV-630 NT	181 (358)	158 (316)	340 (644)
AV-651 BG15	190 (374) ¹	158 (316)	345 (653)
AV-722 BG20	161 (322)	150 (302)	340 (644)
AV-848 NT	252 (486)	158 (316)	340 (644)
AV-621 GF30 BG20	217 (423) ²	158 (316)	340 (644)
AV-651 GF30 BG20	213 (415)	158 (316)	345 (653)
AV-750 GF40 NT	285 (545)	150 (302)	345 (653)
AV-848 GF30 NT	257 (495)	158 (316)	340 (644)
AV-621 CF30	210 (410)	160 (320)	340 (644)
AV-651 CF30	212 (414)	158 (316)	345 (653)
AV-722 CF30	276 (529)	150 (302)	340 (644)
AV-848 CF30	257 (495)	158 (316)	340 (644)
AV-722 SL30	267 (513)	152 (305)	340 (644)
AV-742 SL30	276 (529)	152 (305)	343 (649)
AV-755 SL45	278 (532)	152 (305)	343 (649)

¹ 194 (381) by ISO 75Af

² 216 (421) by ISO 75Af

Both of these tests are actually determining the temperature at which the flexural modulus of the test material is approximately 240 MPa (35,000 psi) when the applied stress is 0.45 MPa (66 psi) or 965 MPa (140,000 psi) when the applied stress is 1.8 MPa (264 psi).

The heat deflection temperatures shown in Table 5.3 were determined according to ASTM D648 using 1.8 MPa (264 psi) stress. The 3.2 mm (0.125 inch) specimens were annealed for 2 hours at 200 °C (392 °F).

Glass Transition Temperature (T_g)

Most polymers can exist in two different states, glassy and rubbery. In the glassy state, molecular mobility is limited to vibrations of atoms and motion of a few atoms along main chains or side chains. In the rubbery state movements of segments allow flexing and uncoiling that permit more elasticity and even translational motion of entire molecules associated with polymer flow. The temperature at which the material goes from a glassy to a rubbery state is defined as the glass transition temperature (T_g). This temperature is important because several fundamental changes occur at this temperature. These include changes in polymer free volume, refractive index, enthalpy, and specific heat.

The glass transition temperature was measured according to ASTM D3418, which uses differential scanning calorimetry (DSC). The test consists of heating the test specimen at a controlled rate and continuously monitoring the difference in heat input between a reference material and the test specimen due to energy changes in the material.

The specimens were given a preliminary thermal cycle, cooled, and then tested a second time. From the second heat, the T_g was taken as the temperature at the midpoint of the change in heat capacity.

Melting Temperature (T_m)

The crystalline melting temperature (T_m) is the temperature at which the polymer transitions from a crystalline or semi-crystalline state to a completely amorphous state. It is also measured according to ASTM D3418, usually as the end of the procedure that provides the glass transition temperature. It is also taken from the second heat.

Table 5.3 lists the heat deflection, glass transition, and melting temperatures for selected grades of AvaSpire® polyetheretherketone (PAEK).

Thermal Conductivity

Polymers in general are poor conductors of heat. For many applications, this is desirable because the polymer provides a measure of thermal isolation.

Many methods for measuring thermal conductivity have been developed. They can be classified into two groups: transient and steady state. Transient methods usually use needle probes and are best used for situations where the temperature changes with time. The steady state techniques can be more accurate. ASTM E1530, entitled “Evaluating the Resistance to Thermal Transmission of Materials by the Guarded Heat Flow Meter Technique”, is a steady state technique used for the thermal conductivity data in this document.

A specimen and a heat flux transducer are placed between two flat plates controlled at different temperatures. A specified load is applied to the stack to ensure contact between the specimen and the plates. At steady state, the difference in temperature between the plates is measured with sensors embedded in the plates, along with the output of the heat flux transducer. The output voltage is proportional to the heat flow through the specimen. The proportionality is obtained by prior calibration with materials of known thermal resistance.

Materials with the lowest thermal conductivity are unreinforced resins. Glass fiber has higher thermal conductivity than the polymer, so glass-filled compounds have higher conductivity than neat resins. Likewise, carbon fibers are more thermally conductive than glass fibers, so carbon fiber-reinforced grades are more thermally conductive than the neat or glass-filled grades. The amount of the increase in thermal conductivity for the carbon fiber-reinforced grades is not as large as expected due to fiber orientation. The fibers are mostly oriented in the flow direction which is perpendicular to the testing direction through the thickness of the plaque. If an application requires a specific thermal conductivity, prototype testing or modeling should be performed.

The thermal conductivity of several grades of AvaSpire® PAEK is shown in Table 5.4.

Specific Heat

Specific heat is defined as the amount of heat required to change the temperature of a unit mass one degree. The specific heat was measured using differential scanning calorimetry following the recommendations of ASTM E1269. The test consists of heating the material at a controlled rate in a controlled atmosphere through the temperature range of interest. The difference in heat flow into the material and a reference material due to energy changes in the material is continually monitored and recorded.

The specific heat capacity values of several grades of AvaSpire® PAEK are shown in Table 5.5.

Table 5.4 Thermal conductivity of AvaSpire® PAEK

Grade	Thermal Conductivity	
	[W/m·K]	[BTU·inch/h·ft ² ·°F]
AV-621 NT	0.20	1.39
AV-630 NT	0.23	1.60
AV-651 BG15	0.24	1.67
AV-722 BG20	0.22	1.53
AV-848 NT	0.22	1.53
AV-621 GF30 BG20	0.28	1.94
AV-651 GF30 BG20	0.30	2.08
AV-750 GF40 NT	0.31	2.15
AV-848 GF30 NT	0.29	2.01
AV-621 CF30	0.35	2.43
AV-651 CF30	0.36	2.50
AV-722 CF30	0.34	2.36
AV-848 CF30	0.37	2.56
AV-722 SL30	0.30	2.08
AV-742 SL30	0.34	2.36
AV-755 SL45	0.70	4.86

Table 5.5 Specific heat capacity of AvaSpire® PAEK

Grade	200 °C (392 °F)	
	[kJ/kg·°C]	[Btu/lb·°F]
AV-621 NT	2.00	0.48
AV-630 NT	1.96	0.47
AV-651 BG15	1.82	0.43
AV-722 BG20	1.97	0.47
AV-848 NT	1.66	0.40
AV-621 GF30 BG20	1.66	0.40
AV-651 GF30 BG20	1.65	0.39
AV-750 GF40 NT	1.62	0.39
AV-848 GF30 NT	1.71	0.41
AV-621 CF30	1.81	0.43
AV-651 CF30	1.77	0.42
AV-722 CF30	1.74	0.42
AV-722 SL30	1.81	0.43
AV-742 SL30	1.71	0.41
AV-755 SL45	1.61	0.38

Thermal Stability

Nearly all polymeric materials exhibit some loss of performance properties after long-term exposure to elevated temperatures. Some of the property changes are the result of thermal-oxidative degradation, but not all property changes are the result of degradation. Some changes in polymer morphology can result simply from high-temperature exposure. Two common methods for evaluating thermal stability are heat aging and thermogravimetric analysis (TGA).

Heat Aging

Thermal oxidative stability limits the acceptable long-term use temperature of some polymers. To evaluate these long-term effects on the properties of AvaSpire® polyaryletherketone (PAEK), molded test specimens were placed in circulating air ovens at several elevated temperatures. Specimens were removed from the oven at regular intervals, then tested at room temperature.

Test Procedures

To evaluate the effects of long-term heat aging on the properties of AvaSpire® PAEK, test specimens conforming to the dimensional requirements of ASTM D638 Type 1 and ASTM D256 were molded from several grades of AvaSpire® PAEK. The molded bars were placed in circulating air ovens at 180 °C (356 °F), 200 °C (392 °F), and 220 °C (428 °F). Specimens were removed from the oven at regular intervals, then tested at room temperature for tensile properties according to ASTM D638 and Izod impact resistance according to ASTM D256.

Results

The results obtained after 5,000 hours of aging are shown in Table 5.6 and Figures 5.5 through 5.8. The values in the table for the control are unaged but annealed values. In the Figures these are shown as the 23 °C value. Annealing was done for 2 hours at 200 °C (392 °F).

AvaSpire® AV-621 NT has good retention of properties after heat aging up to 200 °C (392 °F).

AV-621 GF30 BG20 has excellent retention of tensile strength and modulus after heat aging at all 3 temperatures, and despite modest decreases in notched Izod, practical toughness is maintained.

AV-621 CF30 shows excellent thermal stability with almost no property changes up to 220 °C (428 °F).

AV-722 CF30 shows good property retention when aged at 180 °C (356 °F). This grade is not recommended for applications requiring high levels of thermal stability at temperatures above 180 °C (356 °F).

AV-750 GF40 also has good retention at 180 °C (356 °F) and is also not recommended for higher temperatures.

AV-848 CF30 has good thermal stability up to 220 °C (428 °F). Tensile strength is very slightly reduced but Izod impact strength is retained.

Table 5.6 Heat aging results

AvaSpire® Grade	Unit	Aging Temperature	Aging Time [Hours]		
			0 (Control)	2,000	5,000
AV-621 NT					
Tensile Strength	MPa (kpsi)	180 °C (356 °F)	91 (13.2)	96 (13.9)	96 (13.9)
		200 °C (392 °F)	91 (13.2)	99 (14.4)	96 (13.9)
Tensile Modulus	GPa (kpsi)	180 °C (356 °F)	3.23 (468)	3.23 (469)	3.24 (470)
		200 °C (392 °F)	3.23 (468)	3.31 (480)	3.28 (476)
Tensile Elongation at Break	%	180 °C (356 °F)	41	40	34
		200 °C (392 °F)	41	25	18
Izod Impact Strength	J/m (ft-lb/in.)	180 °C (356 °F)	96 (1.8)	88 (1.6)	84 (1.6)
		200 °C (392 °F)	96 (1.8)	89 (1.7)	82 (1.5)
AV-621 GF30					
Tensile strength	MPa (kpsi)	180 °C (356 °F)	159 (23.0)	161 (23.3)	159 (23.1)
		200 °C (392 °F)	159 (23.0)	161 (23.4)	160 (23.2)
		220 °C (428 °F)	159 (23.0)	159 (23.0)	156 (22.6)
Tensile modulus	GPa (kpsi)	180 °C (356 °F)	10.34 (1,500)	10.14 (1,470)	10.41 (1,510)
		200 °C (392 °F)	10.34 (1,500)	10.20 (1,480)	10.48 (1,520)
		220 °C (428 °F)	10.34 (1,500)	10.48 (1,520)	10.69 (1,550)
Tensile elongation at break, %	%	180 °C (356 °F)	3.2	2.7	2.7
		200 °C (392 °F)	3.2	2.7	2.5
		220 °C (428 °F)	3.2	2.3	2.2
Izod impact strength	J/m (ft-lb/in.)	180 °C (356 °F)	115 (2.2)	110 (2.1)	102 (1.9)
		200 °C (392 °F)	115 (2.2)	101 (1.9)	85 (1.6)
		220 °C (428 °F)	115 (2.2)	82 (1.5)	66 (1.2)
AV-621 CF30					
Tensile strength	MPa (kpsi)	180 °C (356 °F)	192 (27.9)	193 (28.0)	192 (27.8)
		200 °C (392 °F)	192 (27.9)	198 (28.7)	208 (30.1)
		220 °C (428 °F)	192 (27.9)	194 (28.1)	200 (29.0)
Tensile modulus	GPa (kpsi)	180 °C (356 °F)	21.10 (3,060)	20.80 (3,010)	21.20 (3,080)
		200 °C (392 °F)	21.10 (3,060)	20.70 (3,000)	22.00 (3,190)
		220 °C (428 °F)	21.10 (3,060)	20.80 (3,020)	21.40 (3,100)
Tensile elongation at break	%	180 °C (356 °F)	1.7	1.5	1.5
		200 °C (392 °F)	1.7	1.6	1.9
		220 °C (428 °F)	1.7	1.8	1.7
Izod impact strength	J/m (ft-lb/in.)	180 °C (356 °F)	79 (1.5)	74 (1.4)	70 (1.3)
		200 °C (392 °F)	79 (1.5)	76 (1.4)	71 (1.3)
		220 °C (428 °F)	79 (1.5)	76 (1.4)	63 (1.2)
AV-722 CF30					
Tensile strength	MPa (kpsi)	180 °C (356 °F)	216 (31.4)	204 (29.6)	188 (27.2)
Tensile modulus	GPa (kpsi)	180 °C (356 °F)	24.90 (3,610)	24.60 (3,570)	26.80 (3,880)
Tensile elongation at break	%	180 °C (356 °F)	1.4	1.2	0.9
Izod impact strength	J/m (ft-lb/in.)	180 °C (356 °F)	63 (1.2)	39 (0.7)	42 (0.8)
AV-750 GF40					
Tensile strength, MPa (kpsi)		180 °C (356 °F)	196 (28.4)	182 (26.4)	172 (25.0)
Tensile modulus, GPa (kpsi)		180 °C (356 °F)	16.20 (2,350)	15.90 (2,310)	16.90 (2,450)
Tensile elongation at break, %		180 °C (356 °F)	1.7	1.4	1.2
Izod impact strength, J/m (ft-lb/in.)		180 °C (356 °F)	66 (1.2)	63 (1.2)	58 (1.1)

Aging Time [Hours]

AvaSpire® Grade	Unit	Aging Temperature	0 (Control)	2,000	5,000
AV-848 CF30					
Tensile sStrength, MPa (kpsi)		180 °C (356 °F)	203 (29.5)	195 (28.3)	197 (28.6)
		200 °C (392 °F)	203 (29.5)	201 (29.2)	203 (29.4)
		220 °C (428 °F)	203 (29.5)	192 (27.8)	185 (26.8)
Tensile modulus, GPa (kpsi)		180 °C (356 °F)	22.90 (3,320)	21.80 (3,160)	23.10 (3,350)
		200 °C (392 °F)	22.90 (3,320)	22.00 (3,190)	23.00 (3,330)
		220 °C (428 °F)	22.90 (3,320)	22.10 (3,200)	23.30 (3,380)
Tensile elongation at break, %		180 °C (356 °F)	1.4	1.3	1.3
		200 °C (392 °F)	1.4	1.2	1.3
		220 °C (428 °F)	1.2	1.1	1.0
Izod impact strength, J/m (ft-lb/in.)		180 °C (356 °F)	49 (0.9)	48 (0.9)	49 (0.9)
		200 °C (392 °F)	49 (0.9)	48 (0.9)	49 (0.9)
		220 °C (428 °F)	49 (0.9)	45 (0.8)	48 (0.9)

Figure 5.5 Tensile strength¹

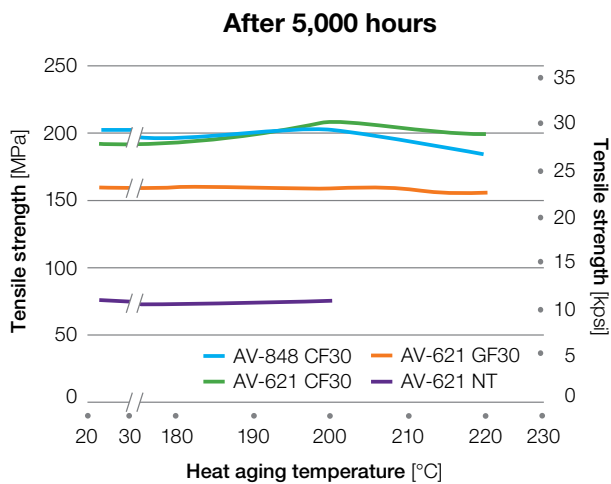

Figure 5.7 Tensile Elongation at break¹

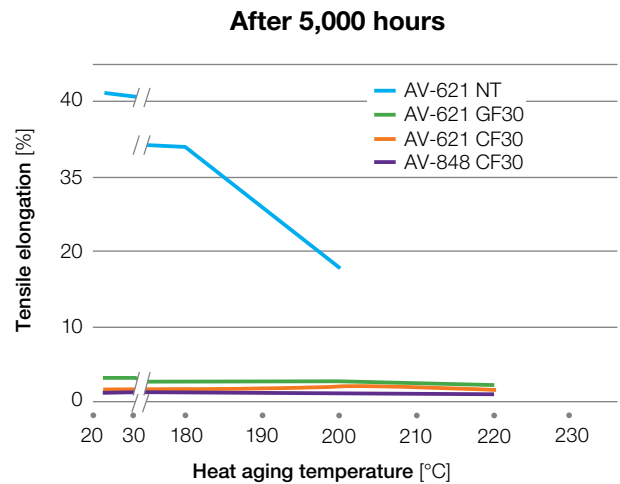

Figure 5.6 Tensile modulus¹

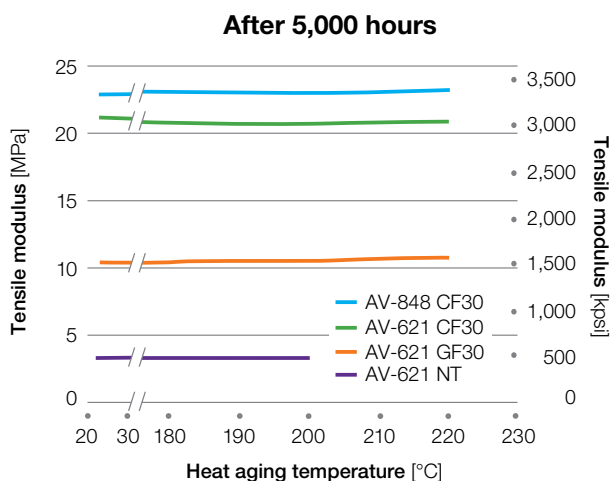
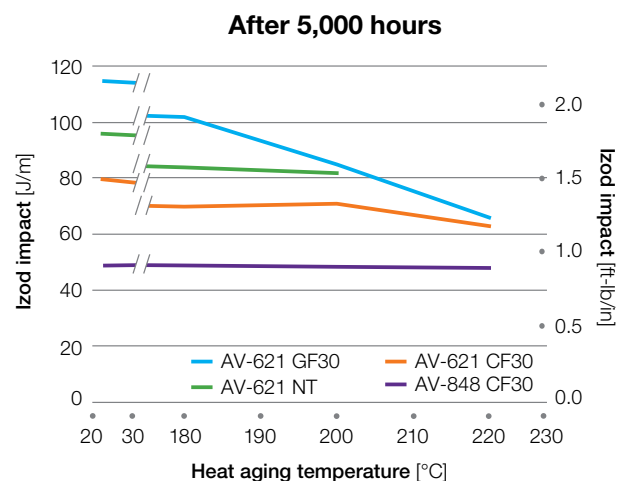

Figure 5.8 Notched Izod impact¹



¹ Values shown at 23 °C are unaged, as molded and annealed controls.

Thermogravimetric Analysis (TGA)

Thermogravimetric analysis is performed by increasing the temperature of a small sample of the test material at a constant rate while monitoring its weight. The atmosphere is controlled and the test can be performed using air or an inert atmosphere, such as nitrogen.

The instrument usually consists of a high-precision balance with a pan (generally platinum) loaded with the sample. The sample is placed in a small electrically heated oven with a thermocouple to accurately measure the temperature. The output of the analysis is a weight versus temperature plot.

Figures 5.9 through 5.12 shows the weight loss versus temperature (TGA) plots for AvaSpire® PAEK grades when heated in air. Figures 5.13 through 5.18 show the TGA curves when heated in a nitrogen atmosphere. Table 5.7 gives a summary of the weight loss temperatures for all the grades tested. The data show that AvaSpire® PAEK is thermally stable to temperatures well above those used for processing the material or those expected in service.

Figure 5.9 TGA AV-621 NT in Air

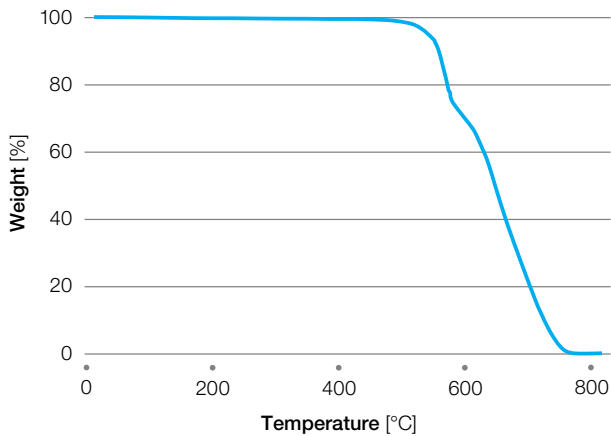

Figure 5.10 TGA AV-630 NT in Air

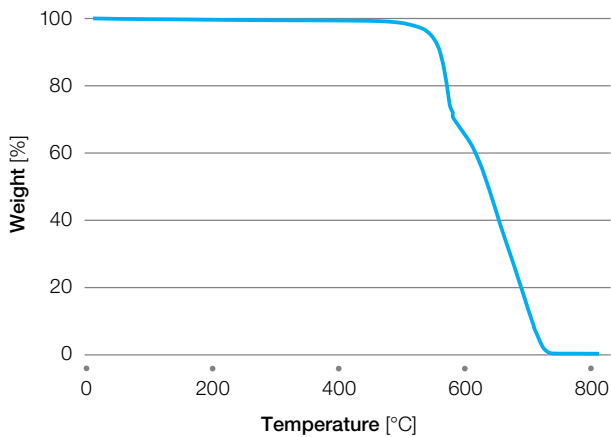

Figure 5.11 TGA AV-651 BG15 in Air

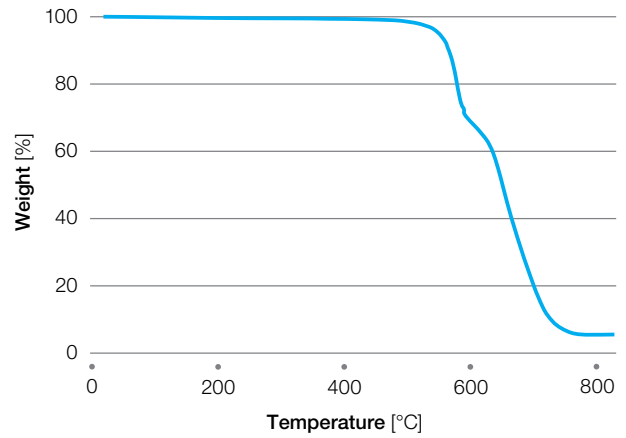

Figure 5.12 TGA AV-722 BG20 in Air

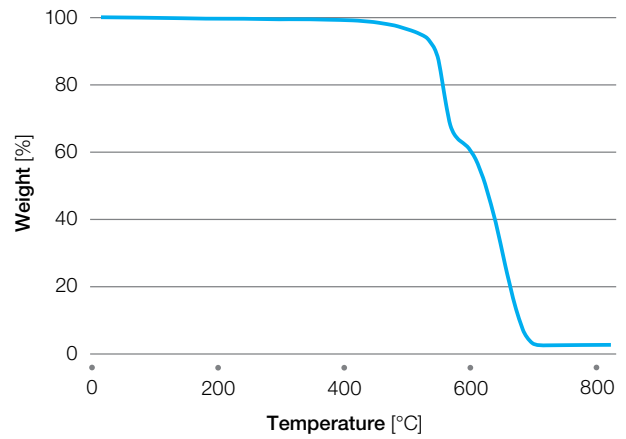

Figure 5.13 TGA AV-848 NT in Air

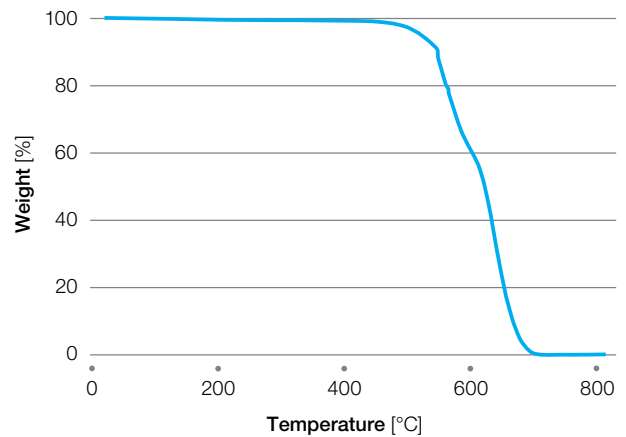

Figure 5.14 TGA AV-621 NT in N2

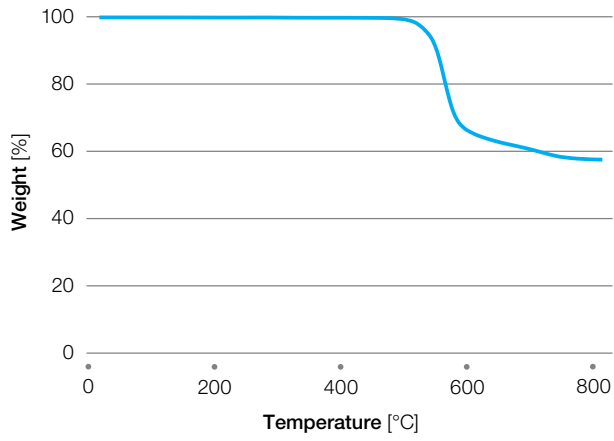

Figure 5.17 TGA AV-722 BG20 in N2

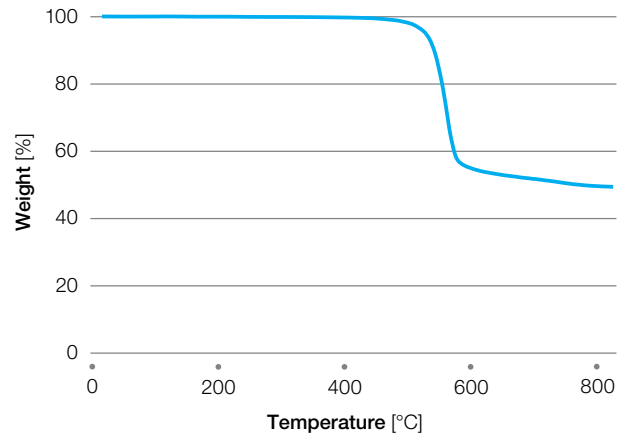

Figure 5.15 TGA AV-630 NT in N2

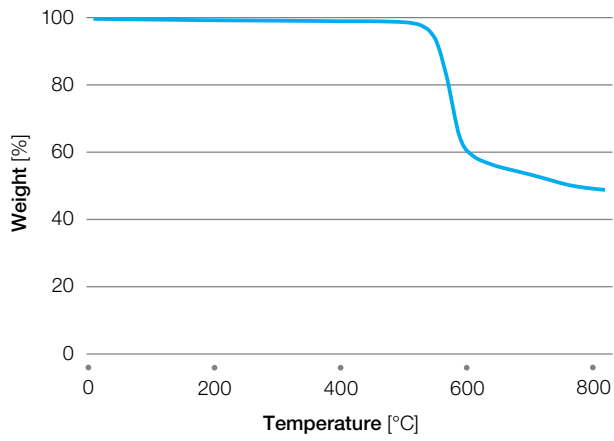

Figure 5.18 TGA AV-848 NT in N2

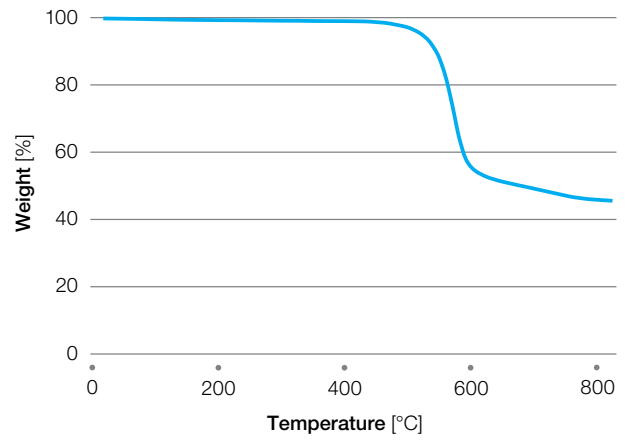

Figure 5.16 TGA AV-651 BG15 in N2

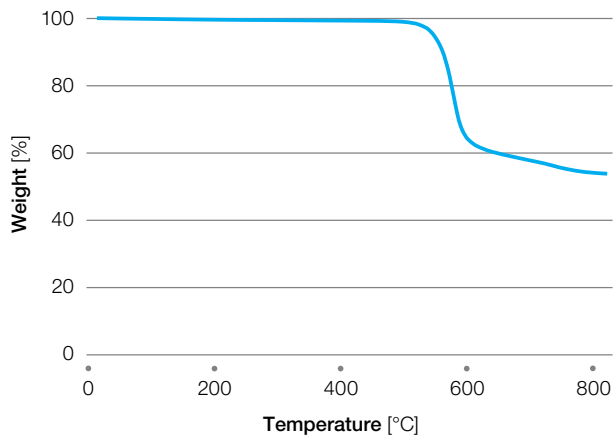

Table 5.7 TGA Summary

AvaSpire® Grade	Atm	Weight Loss Temperature [°C (°F)]			
		1 %	2 %	5 %	10 %
AV-621 NT	Air	463 (865)	505 (941)	532 (990)	550 (1022)
AV-630 NT	Air	480 (896)	514 (957)	542 (1008)	555 (1031)
AV-651 BG15	Air	430 (806)	498 (928)	532 (990)	548 (1018)
AV-722 BG20	Air	398 (748)	457 (855)	508 (946)	532 (990)
AV-848 NT	Air	408 (766)	475 (887)	512 (954)	539 (1002)
PEEK	Air	513 (955)	536 (997)	551 (1024)	559 (1038)
AV-621 NT	N ₂	503 (937)	515 (959)	531 (988)	544 (1011)
AV-630 NT	N ₂	475 (887)	518 (964)	538 (1000)	549 (1020)
AV-651 BG15	N ₂	455 (851)	512 (954)	534 (993)	548 (1018)
AV-722 BG20	N ₂	465 (869)	490 (914)	514 (957)	527 (981)
AV-848 NT	N ₂	409 (768)	471 (880)	510 (950)	531 (988)
PEEK	N ₂	523 (973)	530 (986)	542 (1008)	551 (1024)

Combustion Properties

When a polymeric material, such as AvaSpire® polyaryletherketone (PAEK), is exposed to a flame in the presence of air, some combustion or burning can occur. The extent and nature of the combustion varies as a function of the material, the ignition source, and the atmosphere. A variety of tests have been developed to evaluate combustion behavior. The data reported in this document include the results of Glow-Wire, UL 94, Oxygen Index, and FAA 25.853 tests.

Glow Wire Testing

The glow wire test determines the relative resistance to ignition of a plastic insulating material from an electrically heated wire. This test simulates conditions present when an exposed, current carrying conductor contacts an insulating material during faulty or overloaded operation. This test is part of UL 746A, section 34, but references IEC test method 60695-2-12, -13.

The glow wire test apparatus consists of a loop of heavy gauge nickel-chromium resistance wire, a thermocouple, and a sample mounting bracket. During the test, an electrical current is passed through a nickel-chromium loop in order to obtain a predetermined temperature. The sample is then brought in contact with the wire for 30 seconds. If after withdrawal, the sample displays no flame or glowing, or if so, it is self-extinguishing after 30 seconds, then the sample is given a passing rating.

The test can be applied at one or more recommended temperatures and at any wall thickness needed. Recommended temperatures are 550 °C (1022 °F), 650 °C (1202 °F), 750 °C (1382 °F), 850 °C (1562 °F), and 960 °C (1760 °F). Thickness is usually mandated by the design or the requirements of the device. It is most difficult to resist ignition at the high glow wire temperature and thinner wall sections.

Glow wire ignitability temperature (GWIT) is defined as the temperature (in °C), which is 25 °C hotter than the maximum temperature of the tip of the glow wire that does not cause ignition of the material during three subsequent tests.

Glow wire flammability temperature (GWFI) is defined as the highest temperature (in °C) at which during three subsequent tests, flaming or glowing of the test specimen extinguishes within 30 seconds after removal of the glow wire without ignition of the indicator by burning drips or particles.

Table 5.8 Glow wire flammability of AvaSpire® PAEK

Grade	Thickness [mm (in.)]	GWIT [°C]	GWFI [°C]
AV-651 GF30	0.9 (0.035)	825	960
	1.5 (0.059)	850	960
	3.0 (0.118)	850	960

Vertical Flammability per UL 94

The UL 94 flammability standard established by Underwriters' Laboratories is a system by which plastic materials can be classified with respect to their ability to withstand combustion. The flammability rating given to a plastic material is dependent upon the response of the material to heat and flame under controlled laboratory conditions and serves as a preliminary indicator of its acceptability with respect to flammability for a particular application. The actual response to heat and flame of a thermoplastic depends on other factors such as the size, form, and end-use of the product using the material. Additionally, characteristics in end-use application such as ease of ignition, burning rate, flame spread, fuel contribution, intensity of burning, and products of combustion will affect the combustion response of the material.

Three primary test methods comprise the UL 94 standard: the Horizontal Burning Test, the 50 W (20 mm) Vertical Burning Test, and the 500 W (125 mm) Vertical Burning Test.

Horizontal burning test

For a 94HB classification rating, injection molded test specimens are limited to a 125 mm (5.0 in.) length, 13 mm (0.5 in.) width and the minimum thickness for which the rating is desired. The samples are clamped in a horizontal position with a 20 mm (0.79 in.) blue flame applied to the unclamped edge of the specimen at a 45 degree angle for 30 seconds or as soon as the combustion front reaches a premarked line 25 mm (0.98 in.) from the edge of the bar. After the flame is removed, the rate of burn for the combustion front to travel from the 25 mm (0.98 in.) line to a premarked 100 mm (3.94 in.) line is calculated. At least three specimens are tested in this manner. A plastic obtains an HB rating by not exceeding a burn rate of 40 mm/min (1.57 in./min) for specimens having a thickness greater than 3 mm (0.12 in.) or 75 mm/min (2.95 in./min) for bars less than 3 mm (0.12 in.) thick. The rating is also extended to products that do not support combustion to the 100 mm (3.94 in.) reference mark.

50 W (20 mm) Vertical burn test

Materials can be classified V-0, V-1, or V-2 on the basis of results obtained from the combustion of samples clamped in a vertical position. The 50 W (20 mm) Vertical Burn Test is more aggressive than the HB test and is done on samples that measure 125 mm (4.92 in.) long, 13 mm (0.51 in.) wide, and the minimum thickness at which the rating is desired, typically 0.8 mm (0.3 in.) or 1.57 mm (0.06 in.). The samples are clamped in a vertical position with a 20 mm (0.79 in.) high blue flame applied to the lower edge of the clamped specimen. The flame is applied for 10 seconds and removed. When the specimen stops burning, the flame is reapplied for an additional 10 seconds and then removed. A total of five bars are tested in this manner.

Table 5.9 lists the criteria by which a material is classified in this test.

Table 5.9 UL criteria for classifying materials V-0, V-1, or V-2

Criteria Conditions	V-0	V-1	V-2
Afterflame time for each individual specimen (t1 or t2)	≤ 10s	≤ 30s	≤ 30s
Total afterflame time for any condition set (t1 + t2 for the 5 specimens)	≤ 50s	≤ 250s	≤ 250s
Afterflame plus afterglow time for each individual specimen after the second flame application (t2 + t3)	≤ 30s	≤ 60s	≤ 60s
Afterflame or afterglow of any specimen up to the holding clamp	No	No	No
Cotton indicator ignited by flaming particles or drops	No	No	Yes

500 W (125 mm) Vertical burning test

A material which passes the flammability requirements established by the 500 W (125 mm) Vertical Burning Test earns either a 5VA or 5VB rating. This particular test is the most severe of the three described. The dimensions of the molded bars used in this test are identical to those used for the 50 W (20 mm) Vertical Burning Test. Additionally, plaques are required that measure 150 mm (5.9 in.) by 150 mm (5.9 in.) by the minimum and maximum thicknesses required for the application. The bars are clamped in a vertical position with a 125 mm (4.92 in.) high flame applied five times for five seconds each time with a five second interval between each application. The plaques are clamped in a horizontal, flat position with a 125 mm (4.92 in.) high flame applied to the bottom surface at a 2 degree angle using the same burn times described for the bars. Table 6 lists the criteria that must be met to obtain a 5VA or 5VB rating.

Table 5.10 UL criteria for classifying materials 5VA or 5VB

Criteria Conditions	5VA	5VB
Afterflame time plus afterglow time after fifth flame application for each individual bar specimen	≤ 60s	≤ 60s
Cotton indicator ignited by flaming particles or drops from any bar specimen	No	No
Burn-through (hole) of any plaque specimen	No	Yes

The UL 94 ratings of AvaSpire® PAEK grades at the time of publication are shown in Table 5.11. These ratings are provided by UL and may change. Please visit the UL website for the current ratings.

Table 5.11 UL 94 ratings of AvaSpire® PAEK

Grade	Thickness, [mm (in.)]	UL 94 Rating
AV-621	3.0 (0.118)	V-0
	1.5 (0.059)	V-0
	0.86 (0.034)	V-0
AV-621 GF30 BG20	3.0 (0.118)	V-0
	1.5 (0.059)	V-0
	0.75 (0.030)	V-1
AV-651	3.0 (0.118)	V-0
	1.5 (0.059)	V-0
	0.75 (0.030)	V-0
AV-651 GF30 BG20	3.0 (0.118)	V-0
	1.5 (0.059)	V-0
	0.9 (0.035)	V-1
	0.75 (0.030)	V-1
AV-651 GF30 BK	3.0 (0.118)	V-0
	1.5 (0.059)	V-0
	0.9 (0.035)	V-0
	0.75 (0.030)	V-0
AV-750 GF40	3.0 (0.118)	V-0
	1.5 (0.059)	V-0
	0.75 (0.030)	V-1

Oxygen Index

Oxygen Index is defined in ASTM D2863 as the minimum concentration of oxygen, expressed as volume percent, in a mixture of oxygen and nitrogen that will support flaming combustion of a material initially at room temperature under the conditions of this method. Since air typically contains around 21 percent oxygen, materials whose oxygen index is appreciably higher than 21 are considered flame-resistant.

The oxygen index value was determined according to ASTM test method D2863 using a Type IV test specimen, which has dimensions of 70 mm to 150 mm (2.75 in. to 5.90 in.) in length by 6.5 mm (0.25 in.) in width by 3.2 mm (0.125 in.) in thickness. Procedure A which uses top surface ignition was used. The test method claims that only results using similar specimens and thickness can be compared. The method also notes that the Type IV specimen will eventually be discontinued in favor of the Type I specimen which can be obtained from the central portion of the ISO 527 tensile bar.

The oxygen indices of AvaSpire® PAEK resins are shown in Table 5.12. These values should only be compared to other values obtained using the same specimen and thickness.

Table 5.12 Oxygen index of AvaSpire® PAEK

Grade	Oxygen Index [%]
AV-621 NT	34
AV-630 NT	38
AV-722 BG20	40

Commercial Aircraft Tests

The Federal Aviation Administration (FAA) regulates aircraft safety and has issued regulations regarding the flammability of components used for aircraft interiors. The applicable regulation is FAR 25.853. The specific test methods for certification of compliance to this regulation are found in Appendix F of Part 25 of CFR Title 14. (For brevity in the rest of this section, this document will simply be referred to as Appendix F.)

Because AvaSpire® PAEK is being considered for components of commercial aircraft by aircraft manufacturers, it has been tested according to Appendix F to show compliance with FAR 25.853, as well as some commercial aircraft manufacturers' specifications. The applicable tests are vertical burn, smoke density, toxic gas emissions, and heat release.

Vertical burn

The details of this test are given in Part 1 of Appendix F. A vertical specimen is exposed to a burner flame for 60 seconds. The flame is removed and the flame time, burn length, and flaming time of drippings, if any, are recorded. The test specimen used had dimensions of 76 x 305 x 2 mm (3 x 12 x 0.080 in.).

The results are shown in Table 5.13. The burn length requirement for some interior panels is less than 2.4 cm (6.0 in.), and for some other components less than 3.1 cm (8.0 in.). The burning length of the AvaSpire® grades tested was about 0.8 cm (2.0 in.) or less, easily meeting the requirement.

Table 5.13 Vertical burn of AvaSpire® PAEK

Grade	Burning Time [sec]	Burning Length [inches]	Longest Burning Particle [sec]	Rating
AV-651 BG15	0	1.4	None	Pass
AV-651 GF30	0	2.1	None	Pass

Smoke density

This test is discussed in Part V of Appendix F. The testing is to be carried out in accordance with the flaming mode of ASTM E662. The test chamber was developed at the National Bureau of Standards (NBS) and was first described in 1967. The test and the chamber are often referred to as the NBS smoke density test and chamber. The maximum acceptable value for specific optical smoke density at 4 minutes is 200.

This test uses an electrically heated radiant energy source mounted within an insulated ceramic tube. The test method allows sample thicknesses up to 25 mm (1 in.). The specimen that was used was a square with nominal dimensions of 76 x 76 x 2 mm (3 x 3 x 0.08 in.). The specimen holder covers the edges of the specimen so the exposed area is 65 mm x 65 mm (2.56 in. x 2.56 in.). A six tube burner is used to apply a row of flamelets across the lower edge of the exposed specimen area. The light transmission is measured with a photometric system using a vertical light path. The specific optical smoke density is calculated from the measured light transmission. The values obtained are specific to the specimen thickness and the specimen assembly and are only useful for comparisons with similar specimens.

Three specimens of each material were tested and the values shown in Table 7 are the average of the three values.

Table 5.14 Smoke density of AvaSpire® PAEK

Grade	Ds at 1.5	Ds at 4.0	Ds Max	Dmax Time [min]	Rating
AV-651 BG15	0	0	0	0	Pass
AV-651 GF30	1	2	2	2.3	Pass

Toxic gas emissions

The measurement and control of toxic gas emissions is not addressed in FAR 25.853. However, two major aircraft manufacturers have established tests to measure toxic gas emissions. Both use the gases generated during the smoke density test run in the NBS smoke chamber. After 4 minutes of flaming mode, the off gases are collected and tested for six toxins.

The results of toxic gas testing on AvaSpire® PAEK are shown in Table 5.14. All values are well below limits prescribed by major aircraft manufacturers.

Heat release rate (OSU)

The test for OSU (Ohio State University) heat release rate appears in Part IV of Appendix F. The requirements for conforming to FAR 25.283 is that the average total heat release does not exceed 65 kilowatt-minutes per square meter and the average peak heat release rate does not exceed 65 kilowatts per square meter.

In this test method, a test specimen is injected into an environmental chamber through which a constant flow of air passes. A radiant heat source is adjusted to produce a heat flux of 3.5 W/cm². With the specimen vertical, combustion is initiated by piloted ignition. The combustion products leaving the chamber are monitored to calculate the release rate of heat.

The apparatus is a modified version of the heat release apparatus in ASTM E906. The test specimens used were nominally 150 x 150 x 2 mm (6 x 6 x 0.080 in.) and three specimens of each material was tested.

The results shown in Table 5.16 suggest that AvaSpire® AV-651 GF30, a 30 % glass fiber reinforced grade, will meet the requirement consistently.

Table 5.15 Toxic gas results for AvaSpire® PAEK

Grade	HCN	CO	NO/ NO ₂	SO ₂	HF	HCl
AV-651 BG15	< 1	50	3	< 1	< 1	< 1
AV-651 GF30	< 1	100	1	< 1	< 1	< 1

Table 5.16: OSU heat release results for AvaSpire® PAEK

Grade	Total Heat Release [kW-min/m ²]	Peak Heat Release Rate [kW/m ²]	Rating
AV-651 BG15	NR	NR	
AV-651 GF30	2	28	Pass

NR = Not Recommended

Electrical Properties

Many applications for thermoplastic resins depend upon their ability to function as electrical insulators, but there are also applications where the ability to dissipate a static charge is desirable. While most base polymers are electrical insulators, additives are available that can be used to provide a range of electrical properties. A wide variety of tests have been developed to measure specific aspects of material performance in electrical applications. A brief description of some of the more common tests are covered here.

Dielectric Breakdown Voltage and Strength

Dielectric strength is a measure of the ability of a material to resist high voltage without dielectric breakdown. It is measured by placing a specimen between two electrodes and increasing the applied voltage until dielectric breakdown occurs. The data in this document was obtained using ASTM Test Method D149 Method A – Short Time Test – with a voltage increase rate of 500 volts per second. The dielectric strength is calculated by dividing the breakdown voltage by the specimen thickness and expressed as kV/mm or volts/mil. Although the results are reported in units of kV/mm (volts/mil), the dielectric strength is not a linear function of thickness. In addition, moisture content and temperature also affect the results. Therefore, data on different materials are comparable only for equivalent sample thickness, moisture content, and test temperature.

The International Electrotechnical Commission (IEC) test method 60243 is essentially an equivalent method.

The dielectric strength of several grades of AvaSpire® polyaryletherketone (PAEK) are shown in Table 6.1. The effect of thickness is clearly seen, with a greater than tenfold increase when the thickness was reduced from 3 mm to 0.05 mm.

Table 6.1 Dielectric strength of AvaSpire® PAEK

Grade	Thickness [mm (inch)]	Dielectric Strength [kV/mm (V/mil)]
AV-621 NT	3.2 (0.125)	16.6 (422)
AV-621 NT	0.05 (0.002)	191 (4,850)
AV-630 NT	0.05 (0.002)	184 (4,680)
AV-651 BG15	3.2 (0.125)	15.8 (403)
AV-722 BG20	3.2 (0.125)	19.3 (491)
AV-722 BG20	0.05 (0.002)	169 (4,300)
AV-848 NT	3.2 (0.125)	19.9 (506)
AV-621 GF30 BG20	3.2 (0.125)	15.0 (383)
AV-651 GF30 BG20	3.2 (0.125)	17.0 (433)
AV-750 GF40 NT	3.2 (0.125)	18.7 (476)
AV-848 GF30 NT	3.2 (0.125)	17.6 (446)

Volume Resistivity

The volume resistivity of a material is defined as the electrical resistance of a unit cube of material. Materials with higher volume resistivity are more effective at electrically isolating components. The test method used was ASTM D257 which is appropriate for highly insulative materials. The dielectric resistance depends on the applied voltage and the time of electrification. The data in this document used the standard conditions of an applied voltage of 500 volts DC and an electrification time of 60 seconds.

Grades containing carbon fiber reinforcement were not tested by this method because they may be moderately conductive and a different test method is specified for this type of material.

Volume resistivity is particularly sensitive to changes in temperature and humidity. Data on different materials are comparable only for equivalent moisture content and temperatures. Materials with resistivities above 10^8 ohm-cm are considered insulators, while those with values of 10^3 to 10^8 ohm-cm are partial conductors.

IEC test method 60093 is essentially an equivalent method and should give comparable results for equivalent electrode geometry, applied voltage, electrification time, moisture content, and temperature.

The volume and surface resistivities of several grades of AvaSpire® PAEK are shown in Table 6.2.

Table 6.2 Volume and surface resistivity of AvaSpire® PAEK

Grade	Volume Resistivity [ohms-cm]	Surface Resistivity [ohms]
AV-621 NT	6.2×10^{17}	$> 1.9 \times 10^{17}$
AV-630 NT	6.2×10^{17}	$> 1.9 \times 10^{17}$
AV-651 BG15	5.0×10^{17}	$> 1.9 \times 10^{17}$
AV-722 BG20	3.1×10^{17}	$> 1.9 \times 10^{17}$
AV-848 NT	6.0×10^{16}	$> 1.9 \times 10^{17}$
AV-621 GF30 BG20	2.1×10^{17}	$> 1.9 \times 10^{17}$
AV-651 GF30 BG20	2.0×10^{17}	$> 1.9 \times 10^{17}$
AV-750 GF40 NT	1.8×10^{17}	$> 1.9 \times 10^{17}$
AV-848 GF30 NT	1.8×10^{17}	$> 1.9 \times 10^{17}$

Surface Resistivity

The surface resistivity of a material is the electrical resistance between two electrodes on the surface of the specimen. The same test method used for volume resistivity, ASTM D257, is used for surface resistivity. The material is subjected to 500 volts DC for 1 minute, and the current along the surface of the material is measured. Although some finite thickness of material is actually carrying the current, this thickness is not measurable, therefore, this property is an approximate measure. Surface resistivity is affected by surface contamination and is not considered a basic material property. Data from this test are best used to compare materials for use in applications where surface leakage is a concern.

As stated earlier, IEC test method 60093 is essentially an equivalent method and should give comparable results for equivalent electrode geometry, applied voltage, electrification time, moisture content, and temperature.

Dielectric Constant

Insulating materials are used in two very distinct ways. The first is to support and insulate components from each other and the ground; the second is to function as a capacitor dielectric. The dielectric constant or relative permittivity of a material is defined as the ratio of the capacitance of a condenser using the test material as the dielectric to the capacitance of the same condenser with a vacuum replacing the dielectric. In the first case, it is desirable to have a low dielectric constant. In the second case, a high dielectric constant allows the capacitor to be physically smaller.

The measurement of the dielectric constant was done according to ASTM D150. Capacitance and AC resistance measurements are made on a specimen. The test is performed at several frequencies. Dielectric constants have been found to change rapidly with increasing temperature or moisture content, hence data on different materials are comparable only at equivalent moisture content and temperature.

IEC 60250 test method is quite similar to ASTM D150 and if the same electrode type, electrode geometry, and capacitance measurement apparatus are used, similar results should be obtained.

Dissipation Factor

Dissipation factor (also referred to as loss tangent or tan delta) is a measure of the dielectric loss, or energy dissipated, when alternating current loses energy to an insulator. In general, low dissipation factors are desirable because they correspond to a better dielectric material.

The same ASTM test method used for dielectric strength, D150, is used for dissipation factor. It is also measured at several frequencies. Again, IEC 60250 appears to be an equivalent test method.

Contamination, testing frequency, temperature, and humidity can affect the dissipation factor.

The dielectric constants and dissipation factors measured at room temperature of several AvaSpire® PAEK grades are shown in Table 6.3.

Table 6.3 Dielectric constants and dissipation factors of AvaSpire® PAEK

Grade	Frequency	Dielectric Constant	Dissipation Factor
AV-621 NT	60 Hz	3.10	0.001
	10^3 Hz	3.12	0.001
	10^6 Hz	3.07	0.004
AV-651 BG15	60 Hz	3.10	0.001
	10^3 Hz	3.12	0.001
	10^6 Hz	3.10	0.004
AV-722 BG20	60 Hz	3.12	0.001
	10^6 Hz	3.06	0.004
AV-848 NT	60 Hz	3.21	0.002
	10^3 Hz	3.23	0.001
	10^6 Hz	3.18	0.006
AV-621 GF30 BG20	60 Hz	3.52	0.001
	10^3 Hz	3.53	0.001
	10^6 Hz	3.48	0.005
AV-651 GF30 BG20	60 Hz	3.61	0.002
	10^3 Hz	3.63	0.000
	10^6 Hz	3.58	0.004
AV-750 GF40 NT	60 Hz	3.68	0.002
	10^3 Hz	3.69	0.001
	10^6 Hz	3.66	0.003
AV-848 GF30 NT	60 Hz	3.74	0.002
	10^6 Hz	3.69	0.006

UL 746A Short-Term Properties

Certain electrical properties are included in the Underwriters' Laboratories (UL) Standard 746A entitled Standard for Polymeric Materials Short-Term Property Evaluations. Many of these properties are reported by "Performance Level Category" (PLC). For each property, UL has specified test result ranges and corresponding Performance Level Categories. Desired or best performance is assigned to a PLC of 0; therefore, the lower the PLC, the better the performance in that test. The properties and assigned PLC's are described in the following section. Values and PLC's for AvaSpire® PAEK are shown in Table 6.10.

High-voltage, low-current, dry arc resistance – ASTM D495

This test measures the time, in seconds, that a 12,500 volt arc can travel between two tungsten rod electrodes on the surface of a material, following a specified test sequence of increasing severity, until a conductive path or track is formed. This test is intended to approximate service conditions in alternating-current circuits operating at high voltage with currents generally limited to less than 0.1 ampere. Table 6.4 shows the relationship between the arc resistance and the UL assigned Performance Level Categories.

Table 6.4 High-voltage, low-current, dry arc resistance performance level categories

Value Range [sec]		Assigned PLC
≥	<	
420		0
360	420	1
300	360	2
240	300	3
180	240	4
120	180	5
60	120	6
0	60	7

Comparative Tracking Index (CTI) – ASTM D3638

The Comparative Tracking Index is defined as the voltage that causes the formation of a permanent electrically conductive carbon path when 50 drops of electrolyte are applied at a rate of 1 drop every 30 seconds. This test measures the susceptibility of an insulating material to tracking. Table 6.5 shows the relationship between the voltage obtained and the PLC.

Table 6.5 Comparative tracking index performance level categories

Value Range [Volts]		Assigned PLC
≥	<	
600	X	0
400	600	1
250	400	2
175	250	3
100	175	4
0	100	5

High-Voltage Arc Tracking Rate (HVTR)

This test measures the susceptibility of an insulating material to form a visible carbonized conducting path (track) over its surface when subjected to repeated high-voltage, low-current arcing. The high-voltage arc tracking rate value is the rate, in mm/minute, at which a conducting path is produced on the surface of a material under standardized test conditions. This test simulates a malfunctioning high-voltage power supply with lower values indicating better performance. Table 6.6 shows the HVTR values and the corresponding PLC.

Table 6.6 High-voltage arc tracking rate performance level categories

Value Range [mm/min]		Assigned PLC
>	≤	
0	10	0
10	25.4	1
25.4	80	2
80	150	3
150		4

Hot Wire Ignition (HWI) - ASTM D3874

This test measures the relative resistance of plastic materials to ignition by an electrically heated wire. A portion of a test specimen is wrapped with a heater wire under specified conditions and a current is passed through the wire at a linear power density of 0.26 W/mm (6.5 W/inch). The current flow is maintained until ignition occurs, and the time to ignition is recorded.

Under certain operational or malfunction conditions, components become abnormally hot. If these overheated components are in intimate contact with the insulating materials, the insulating material may ignite. The intention of this test is to determine relative resistance of insulating materials to ignition under these conditions. Table 6.7 shows the hot wire ignition times and the assigned PLC.

Table 6.7 Hot wire ignition performance level categories

Value Range [sec]		Assigned PLC
<	≥	
	120	0
120	60	1
60	30	2
30	15	3
15	7	4
7	0	5

High-Current Arc Ignition (HAI)

This test measures the relative resistance of insulating materials to ignition from arcing electrical sources. Under certain conditions, insulating materials may be in proximity to arcing. If the intensity and duration of the arcing are severe, the insulating material can ignite. This test measures the number of 240-volt, 32.5 ampere arcs on the surface of a material required to cause ignition or a hole. The distance between the electrodes is increased at a rate of 254 mm (10 inches) per second. The maximum number of arcs to be used is 200.

Table 6.8 shows the relationship between the high-current arc ignition value and the UL assigned performance level categories.

Table 6.8 High-current arc ignition performance level categories

Mean Number of Arcs to Cause Ignition		Assigned PLC
<	>	
	120	0
120	60	1
60	30	2
30	15	3
15	7	4
7	0	5

Table 6.10 UL 746A property values and performance level categories of AvaSpire® PAEK

AvaSpire® Grade	Minimum Thickness [mm (inch)]	HWI [sec (PLC)]	HAI [sec (PLC)]	CTI [PLC]	HVTR [mm/min (PLC)]	HVLCAR D495 [sec (PLC)]
AV-651	0.75 (0.030)	18 (3)	143 (1)			
	1.5 (0.059)	22 (3)	150 (1)			
	3.0 (0.118)	49 (2)	119 (1)	4	39 (2)	
AV-651 GF30	0.75 (0.030)	17 (3)	24 (3)			
	1.5 (0.059)	41 (2)	34 (2)			
	3.0 (0.118)	99 (1)	29 (3)	4	138 (3)	130 (5)

High-voltage arc resistance to ignition

This test measures the susceptibility of a material to resist ignition or form a visible carbonized conducting path when subjected to high-voltage, low-current arcing. The application of the high-voltage arc is continued until ignition, a hole is burned through the specimen, or 5 minutes. If ignition occurs, the time to ignition is reported. If ignition does not occur the value > 300 is reported.

The relationship between the mean time to ignition and the performance level categories is given in Table 6.9.

Table 6.9 High-voltage arc resistance to ignition performance level categories

Mean Time to Ignition [sec]		Assigned PLC
<	>	
	300	0
300	120	1
120	30	2
30	0	3

Environmental and Chemical Resistance

AvaSpire® polyaryletherketone (PAEK) is a family of proprietary polymers that provide new and unique combinations of performance and value. These products are compatible with a wide variety of chemicals and end-use environments and, like other high-performance polyketones, are considered to be among the most chemically-resistant polymers commercially available. This feature along with its versatility and distinctive attributes has made AvaSpire® PAEK attractive for applications in aerospace, automotive, chemical processing, medical, oil and gas, electrical, electronic, energy, and other industries.

This bulletin summarizes the results of several testing programs that confirm the material's broad chemical and environmental resistance. Included test media are organic solvents, acids and bases, industrial fluids, aircraft fluids, automotive fluids, several sterilization methods (from gamma radiation to autoclaving), and accelerated outdoor weathering.

Chemical Resistance

AvaSpire® PAEK has excellent chemical resistance and is compatible with many common reagents and industry-specific fluids. The chemical compatibility was evaluated in both stressed and unstressed conditions.

Table 7.1 Compatibility rating system

A	Excellent	Little or no effect
B	Good	No significant loss of properties
C	Fair	Some negative effects, some useful properties retained
D	Poor	Severe attack or rupture

Immersion Testing

To evaluate the unstressed chemical compatibility, tensile bars conforming to ASTM D638 Type 1 were weighed and then immersed in the fluids for 30 days at room temperature. After 30 days, the bars were removed from the environment, rinsed, wiped off, and reweighed. The bars were conditioned according to ASTM D618, then the tensile strength and elongation was then measured and compared to the unexposed value. Any change in appearance was also noted.

In the unstressed condition, AvaSpire® PAEK is similar to PEEK in that it has the excellent chemical resistance of PEEK in most environments, but it is affected by chlorinated hydrocarbons.

The results of the unstressed testing, shown in Table 7.2, indicate that this material has exceptional chemical resistance at room temperature to all the reagents tested, except for methylene chloride.

Stress Testing

Some plastic materials show increased sensitivity to chemical attack when they are stressed. This phenomenon is often a concern with polymers that may have high residual stresses due to molding conditions or may encounter high stress during service. The stress levels in this evaluation are much higher than those typically encountered from molding.

To evaluate the effect of applied external stress upon the chemical resistance of AvaSpire® PAEK, the variable radius strain fixture shown in Figure 7.1 was used. The fixture is marked with numbers that correlate position on the fixture to the radius of curvature at that point. Using the numbers on the fixture and the specimen thickness, the strain at any point can be calculated. From the strain and the tensile modulus of the material, the corresponding stress can be calculated.

Figure 7.1 Variable radius fixture



Prior to testing, the bars were annealed for 2 hours at 200 °C (392 °F). Test specimens were clamped to the fixture and the assembly was immersed in the test solution for 24 hours. After 1 hour and 24 hours the specimens were examined for crazing using strong illumination and magnification. The specimens used for this testing were 127 x 12.7 x 3.2 mm (5 x 0.5 x 0.125 in.).

For this specimen the maximum strain possible with this fixture is 2 %. If no crazing was observed then the critical strain was judged to be greater than 2 %, which for practical purposes means no stress cracking will occur with that reagent.

If crazing is seen, the lowest number on the fixture at which it occurs is noted. From this value and the specimen thickness the applied strain was calculated and defined as the critical strain. From that strain and the elastic modulus, the resultant critical stress was calculated. For strains below the critical strain, crazing will not be observed.

The results of this testing are shown in Table 7.3.

Table 7.2 Unstressed compatibility of AvaSpire® AV-651 BG15 at room temperature

Environment	Weight Change [%]	Retention of Yield Tensile Strength [%]	Retention of Modulus [%]	Rating
Aqueous Acids and Bases				
Hydrochloric acid [37 %]	0.60	99	103	A ⁽¹⁾
Nitric acid [10 %]	0.59	98	101	A ⁽¹⁾
Nitric acid [30 %]	0.52	98	101	A ⁽¹⁾
Sulfuric acid [20 %]	0.55	98	103	A
Sulfuric acid [50 %]	0.24	95	97	A
Potassium hydroxide [45 %]	0.14	101	103	A
Organic Solvents				
Acetone	0.21	93	104	A
Cyclohexane	0.04	101	103	A
Ethanol	0.10	103	105	A
Ethyl acetate	0.21	100	100	A
Methylene chloride	34.1	52	1	F ⁽²⁾
Methyl ethyl ketone	0.20	101	103	A ⁽³⁾
Toluene	0.06	102	100	A
1,1,1-Trichloroethane	0.03	102	100	A
Industrial Fluids				
Dexron III auto trans fluid	0.01	105	103	A
Brake fluid (DOT 3)	0.13	105	103	A
CaCl ₂ brine with SAFE-COR	0.07	105	103	A
Gasoline	0.11	104	105	A
Jet fuel A	0.08	104	102	A
Motor oil (10W-30)	0.17	105	101	A

⁽¹⁾ Slight discoloration⁽²⁾ Swollen⁽³⁾ Surface dulled**Table 7.3** Chemical compatibility under stress

Reagent	AvaSpire® AV-651 BG15		AvaSpire® AV-621 NT		AvaSpire® AV-722 BG20	
	Critical Strain [%]	Critical Stress [MPa (kpsi)]	Critical Strain [%]	Critical Stress [MPa (kpsi)]	Critical Strain [%]	Critical Stress [MPa (kpsi)]
Organic Solvents						
Acetone	1.03 ⁽¹⁾	32 (4.6)	1.03	32 (4.6)	> 2 No effect	> 73 (10.6)
Cyclohexane	> 2 No effect	> 62 (9.0)	> 2 No effect	> 62 (9.0)	> 2 No effect	> 73 (10.6)
Ethanol	> 2 No effect	> 62 (9.0)	> 2 No effect	> 62 (9.0)	> 2 No effect	> 73 (10.6)
Ethyl acetate	0.86 ⁽¹⁾	27 (3.9)	0.86	27 (3.9)	> 2 No effect	> 73 (10.6)
Methylene chloride	0.91 ⁽²⁾	28 (4.1)	0.91 ⁽²⁾	28 (4.1)	> 2 No effect	> 73 (10.6)
Methyl ethyl ketone	0.91 ⁽¹⁾	28 (4.1)	0.91	28 (4.1)	> 2 No effect	> 73 (10.6)
Toluene	0.91 ⁽¹⁾	28 (4.1)	0.91	28 (4.1)	> 2 No effect	> 73 (10.6)
1,1,1-Trichloroethane	> 2 No effect	> 62 (9.0)	> 2 No effect	> 62 (9.0)	> 2 No effect	> 73 (10.6)
Aqueous Acids and Bases						
Sulfuric acid, 20 %	> 2 No effect	> 62 (9.0)	> 2 No effect	> 62 (9.0)	> 2 No effect	> 73 (10.6)
Sulfuric acid, 50 %	> 2 No effect	> 62 (9.0)	> 2 No effect	> 62 (9.0)	> 2 No effect	> 73 (10.6)
Hydrochloric acid, 37 %	> 2 No effect	> 62 (9.0)	> 2 No effect	> 62 (9.0)	> 2 No effect	> 73 (10.6)
Potassium hydroxide, 45 %	> 2 No effect	> 62 (9.0)	> 2 No effect	> 62 (9.0)	> 2 No effect	> 73 (10.6)

⁽¹⁾ Light surface crazing⁽²⁾ Surface etching and dissolution

Transportation Fluid Resistance

The compatibility of AvaSpire® PAEK with various fluids used in the transportation industry was evaluated to comply with specific end use requirements. The results of these evaluations are shown in this section. Obviously not every fluid of interest is included here, nor are all the PAEK grades. In general, AvaSpire® PAEK was not degraded by the transportation fluid tested under the conditions specified. For compatibility to other fluids or for information on other grades, please contact your Solvay representative.

Aircraft Fluids

Skydrol® LD-4 hydraulic fluid

The compatibility of AvaSpire® AV-651 BG15 and AV-651 GF30 BG20 PAEK with Skydrol® LD-4 phosphate ester hydraulic fluid was verified using a commercial aircraft protocol. The results of the evaluation are shown in Table 7.4. Both AvaSpire® PAEK grades show no detrimental effects from exposure to Skydrol® LD-4 and can therefore be considered compatible with Skydrol® LD-4.

Test procedures

Tensile properties were tested by immersing injection-molded ASTM D638 Type 1 test specimens in Skydrol® LD-4 for 7 days at room temperature. After 7 days, the samples were removed, rinsed with water, towel dried, conditioned according to ASTM D618, then tested for tensile strength and modulus according to ASTM D638.

Flexural properties were also evaluated in a similar manner using injection molded bars, 127 x 12.7 x 3.2 mm (5 x 0.5 x 0.125 in.), and testing for strength and modulus according to ASTM D790.

Chemical resistance under stress was verified by clamping unannealed test bars, 127 x 12.7 x 3.2 mm (5 x 0.5 x 0.125 in.), to a fixture having a 127 mm (5 in.) radius. The surface of the bar was swabbed with the reagent. The application of the reagent was repeated after one hour and again after two hours. After 24 hours the test bar was visually inspected for breakage, cracking, or swelling.

Table 7.4 Skydrol® LD-4 compatibility

Property	AvaSpire® AV-651 BG15		AvaSpire® AV-651 GF30 BG20	
	Control	Exposed	Control	Exposed
Tensile strength at yield [MPa (kpsi)]	88.3 (12.8)	88.3 (12.8)	NA	NA
Tensile strength at break [MPa (kpsi)]	68.9 (10.0)	71.7 (10.4)	159.3 (23.1)	158.6 (23.0)
Tensile modulus [GPa (kpsi)]	3.0 (442)	3.0 (442)	10.1 (1470)	10.1 (1470)
Flexural strength [MPa (kpsi)]	126 (18.2)	126 (18.2)	249 (36.1)	246.8 (35.8)
Flexural modulus [GPa (kpsi)]	3.1 (455)	3.1 (455)	9.6 (1390)	9.4 (1370)
Chemical resistance under stress		no effect		no effect

Jet Fuel A/A-1 (ASTM D1655)

The compatibility of AvaSpire® AV-651 BG15 and AV-651 GF30 BG20 PAEK with jet fuel A/A-1 was verified using a commercial aircraft protocol. Table 7.5 contains the results of the evaluation. Both AvaSpire® PAEK grades show no detrimental effects from exposure to jet fuel A/A-1 and can therefore be considered compatible with jet fuel A/A-1 at room temperature.

Table 7.5 Jet fuel A/A-1 compatibility

Property	AvaSpire® AV-651 BG15		AvaSpire® AV-651 GF30 BG20	
	Control	Exposed	Control	Exposed
Tensile strength at yield [MPa (kpsi)]	88.3 (12.8)	87.6 (12.7)	NA	NA
Tensile strength at break [MPa (kpsi)]	68.9 (10.0)	72.4 (10.5)	159.3 (23.1)	158.6 (23.0)
Tensile modulus [GPa (kpsi)]	3.0 (442)	3.0 (442)	10.1 (1470)	10.2 (1480)
Flexural strength [MPa (kpsi)]	126 (18.2)	126 (18.2)	249 (36.1)	247 (35.9)
Flexural modulus [GPa (kpsi)]	3.1 (455)	3.1 (455)	9.6 (1390)	9.4 (1370)
Chemical resistance under stress		no effect		no effect

Table 7.6 AvaSpire® AV-722 BG20 in ATF

Property	Hours				
	0	500	1,000	2,000	3,000
Tensile strength at yield [MPa (kpsi)]	94 (13.6)	101 (14.7)	101 (14.7)	101 (14.7)	103 (14.9)
Tensile elongation at yield [%]	5.0	4.6	4.6	4.6	4.7
Tensile strength at break [MPa (kpsi)]	80 (11.6)	81 (11.8)	82 (11.9)	82 (11.9)	82 (11.9)
Nominal strain at break [%]	20.3	15.8	12.3	13.8	16.4
Tensile modulus [GPa (kpsi)]	3.7 (535)	3.8 (554)	3.9 (566)	3.9 (566)	3.9 (566)
Flexural strength [MPa (kpsi)]	154 (22.3)	164 (23.8)	165 (24.0)	165 (24.0)	165 (24.0)
Flexural modulus [GPa (kpsi)]	4.0 (583)	4.2 (612)	4.3 (617)	4.3 (617)	4.2 (612)

Table 7.7 AvaSpire® AV-722 CF30 in ATF

Property	Hours				
	0	500	1,000	2,000	3,000
Tensile strength at break [MPa (kpsi)]	208 (30.2)	212 (30.7)	210 (30.4)	209 (30.3)	210 (30.4)
Nominal strain at break [%]	1.4	1.4	1.3	1.2	1.3
Tensile modulus [GPa (kpsi)]	22.3 (3,230)	22.7 (3,290)	22.6 (3,280)	23.3 (3,380)	22.5 (3,260)
Flexural strength [MPa (kpsi)]	305 (44.2)	314 (45.6)	311 (45.1)	297 (43.1)	302 (43.8)
Flexural modulus [GPa (kpsi)]	20.7 (3,000)	21.3 (3,085)	21.7 (3,140)	21.1 (3,070)	21.2 (3,070)

Test procedures

Tensile properties were tested by immersing injection-molded ASTM D638 Type 1 test specimens in the jet fuel for 7 days at room temperature. After 7 days, the samples were removed, rinsed with water, towel dried, conditioned according to ASTM D618, then tested for tensile strength and modulus according to ASTM D638.

Flexural properties were also evaluated in a similar manner using injection-molded bars, 127 x 12.7 x 3.2 mm (5 x 0.5 x 0.125 in.), and testing for strength and modulus according to ASTM D790.

Chemical resistance under stress was verified by clamping unannealed test bars, 127 x 12.7 x 3.2 mm (5 x 0.5 x 0.125 in.), to a fixture having a 127 mm (5 in.) radius. The surface of the bar was swabbed with the jet fuel. The application of the jet fuel was repeated after one hour and again after two hours. After 24 hours the test bar was visually inspected for breakage, cracking, or swelling.

Automotive Fluids**Automatic transmission fluid**

The long-term high-temperature compatibility of AvaSpire® PAEK with automotive automatic transmission fluid (ATF) was evaluated using Dexron® VI ATF fluid at 150 °C (302 °F). AvaSpire® AV-722 BG20 and AV-722 CF30 were evaluated. The results are shown in Tables 7.6 and 7.7. Examination of the data shows that neither AvaSpire® PAEK grade was degraded by soaking in transmission fluid at 150 °C (302 °F) for up to 3,000 hours or 125 days.

Test procedures

Injection molded bars, 127 x 12.7 x 3.2 mm (5 x 0.5 x 0.125 in.) and injection molded bars conforming to Type 1 of ASTM D638 were immersed in Dexron® VI ATF fluid from Chrysan Industries. Prior to immersion, the bars were annealed for 3.5 hours at 150 °C (302 °F). The fluid was heated to 150 °C (302 °F) and the temperature was controlled at 150 °C (302 °F) ± 5 °C (9 °F) until the specified number of hours. After 500 hours, the fluid was cooled to room temperature and bars were removed. The fluid was then reheated and the clock restarted when the temperature of the fluid reached the set point. This process was repeated at 1,000 hours and 2,000 hours. At 3,000 hours, the fluid was again cooled to room temperature and the remaining samples were removed.

At each time interval, the bars were towed off and then conditioned according to ASTM D618. Tensile properties were measured using ASTM test method D638. When testing for test properties, extensometers were used for relatively low elongation values. The elongation of some samples exceed the capability of the extensometer and the elongation values were taken from the crosshead separation. In those cases, the value is shown as nominal strain at break.

Flexural properties were measured using ASTM test method D790. A representative sample of the test specimens were weighed and their thickness measured to check for absorption of the fluid. The values obtained from the immersed samples were compared to the values of unexposed samples. The weight change was less than 0.1 % indicating no significant absorption of the ATF.

Automotive brake fluid

The compatibility of AvaSpire® AV-722 BG20 and AV-722 CF30 PAEK with automotive brake fluid was evaluated using Hydraulac 404 DOT 4 Brake Fluid at 150 °C (302 °F). The results are shown in Tables 7.8 and 7.9. After 3,000 hours, there is no degradation of the mechanical properties of the AvaSpire® PAEK resins.

Table 7.8 AvaSpire® AV-722 BG20 in brake fluid

Property	Hours			
	0	1,000	2,000	3,000
Tensile strength at yield [MPa (kpsi)]	96 (13.9)	95 (13.8)	94 (13.6)	91 (13.2)
Tensile elongation at yield [%]	5.4	4.3	3.9	3.9
Tensile strength at break [MPa (kpsi)]	83 (12.0)	74 (10.7)	75 (10.9)	78 (11.3)
Tensile elongation at break [%]	10.9	16.1	19.6	16.9
Tensile modulus [GPa (kpsi)]	3.7 (537)	4.0 (580)	4.2 (609)	4.0 (580)
Flexural strength [MPa (kpsi)]	118 (17.1)	123 (17.8)	123 (17.8)	120 (17.4)
Flexural modulus [GPa (kpsi)]	3.6 (522)	3.7 (537)	3.8 (551)	3.7 (537)
Notched Izod [kJ/m ² (ft-lb/in ²)]	8.2 (3.9)	5.0 (2.4)	6.1 (2.9)	6.9 (3.3)

Table 7.9 AvaSpire® AV-722 CF30 in brake fluid

Property	Hours			
	0	1,000	2,000	3,000
Tensile strength at break [MPa (kpsi)]	226 (32.8)	231 (33.5)	229 (33.2)	229 (33.2)
Tensile elongation at break [%]	1.5	1.4	1.4	1.6
Tensile modulus [GPa (kpsi)]	24.9 (3,610)	24.9 (3,610)	26.2 (3,800)	26.8 (3,890)
Flexural strength [MPa (kpsi)]	354 (51.3)	346 (50.2)	343 (49.7)	350 (50.8)
Flexural modulus [GPa (kpsi)]	22.6 (3,280)	22.6 (3,280)	22.8 (3,310)	22.6 (3,280)
Notched Izod [kJ/m ² (ft-lb/in ²)]	8.3 (3.9)	7.6 (3.6)	7.3 (3.5)	7.1 (3.4)

Test procedures

To evaluate the compatibility of AvaSpire® PAEK with automotive brake fluid, a testing program utilizing Hydraulac® 404 DOT 4 Brake Fluid was performed. Test bars conforming to the dimensions of ISO Test Method 527 were immersed in the fluid and the fluid was heated to 150 °C (302 °F). After 1,000 hours the fluid was cooled to room temperature, bars were removed, towed off, and tested for tensile properties using ISO test method 527, for flexural properties by ISO test method 178, and for impact by ISO test method 180. Bars were also weighed and measured. The data obtained was compared to that obtained on samples that had not been immersed in the brake fluid. The fluid was then reheated to 150 °C (302 °F) and the clock restarted. After 2,000 hours the fluid was cooled again to room temperature and bars were removed for testing. The fluid was then reheated and held for an additional 1,000 hours at which time the fluid was cooled and the remaining bars removed.

Biodiesel fuel

Biodiesel is a domestic, renewable fuel for diesel engines derived from natural oils like soybean oil, and which meets the specifications of ASTM D 6751. The compatibility of AvaSpire® PAEK with a particular biodiesel blend identified as B30B was evaluated. The results are shown in Table 7.10, immersion in biodiesel fuel at 90 °C (194 °F) even for 3,000 hours has little to no effect on the properties of AvaSpire® AV-621 PAEK.

Table 7.10 AvaSpire® AV-621 NT in biodiesel

Property	Hours		
	0	1,500	3,000
Tensile strength at yield [MPa (kpsi)]	88 (12.8)	89 (12.9)	89 (12.9)
Tensile elongation at yield [%]	6.2	6.0	6.0
Tensile strength at break [MPa (kpsi)]	76 (11.0)	71 (10.3)	73 (10.6)
Tensile elongation at break [%]	100	78	92
Flexural strength [MPa (kpsi)]	96 (13.9)	101 (14.6)	101 (14.6)
Flexural modulus [GPa (kpsi)]	2.9 (420)	3.0 (435)	3.0 (435)
Notched Charpy [kJ/m ² (ft-lb/in ²)]	10.1 (4.8)	10.9 (5.2)	9.3 (4.4)
Unnotched Charpy [kJ/m ² (ft-lb/in ²)]	NB	NB	NB

NB = no break

Test Procedures

Injection molded bars conforming to the dimensional requirements of ISO 527 were immersed in the biodiesel fuel at the fuel was heated to 90 °C (194 °F). Prior to immersion, the bars were not annealed. Bars were removed periodically and tested for mechanical properties. Tensile properties were tested according to ISO 527, flexural properties according to ISO 178, and Charpy impact according to ISO 179.

Motor oil

The compatibility of AvaSpire® AV-722 BG20 PAEK to typical automotive motor oil at 165 °C (329 °F) was evaluated by immersion for 1,000 hours. The results, shown in Table 7.11, indicate that the PAEK was not degraded by the exposure.

Table 7.11 AvaSpire® AV-722 BG20 in motor oil

Property	Hours		
	0	500	1,000
Tensile strength at break [MPa (kpsi)]	71 (10.3)	74 (10.7)	79 (11.4)
Tensile elongation at break [%]	20	14	11
Flexural strength [MPa (kpsi)]	117 (17.0)	125 (18.1)	129 (18.7)
Flexural modulus [GPa (kpsi)]	3.5 (507)	3.6 (522)	3.8 (551)
Notched Charpy 23 °C (73 °F) [kJ/m ² (ft-lb/in ²)]	7.7 (3.6)	6.0 (2.8)	6.0 (2.8)
Notched Charpy -40 °C (-40 °F) [kJ/m ² (ft-lb/in ²)]	6.5 (3.1)	6.2 (2.9)	6.2 (2.9)

Test procedures

The motor oil chosen was Exxon-Mobil 5W-30 SM/GF4. Test specimens conforming to ISO 527 were immersed in the motor oil and the temperature was raised to 165 °C (329 °F). The test duration was 1,000 hours. Samples were removed periodically and the mechanical properties measured at room temperature. Tensile properties were tested according to ISO 527, flexural properties according to ISO 178, and Charpy impact according to ISO 179.

Oil and Gas Fluids Resistance

The oil and gas industry offers challenging applications for polymers. The well fluids and gases encountered are often corrosive, chemically aggressive, toxic, flammable, hot and under pressure. The industry often uses polymers for sealing components, such as piston rings, seals, back-up structures, valve plates and valve seats. Also, polymers used for mechanical or electrical applications by the industry are often exposed to this hostile environment. The exceptional thermal stability, chemical resistance and mechanical properties of AvaSpire® PAEK make it an appropriate candidate for oil and gas applications.

Often the fluids and gases encountered contain significant concentrations of hydrogen sulfide (H₂S), and these are characterized as sour. The same stream with little or no hydrogen sulfide is considered sweet.

The need to understand the performance capability of polymers used in sour service has increased in recent years. Many hydrocarbon producing regions of the world are sour and because the demand for sulfur is dropping, the sour gas is not being processed to remove the sulfur. Instead, it is being re-injected to reduce costs and comply with environmental and safety regulations, thus increasing the amount of sour production streams. Compliance with environmental and safety regulations pertaining to sour gas re-injection along with increased production and reduced maintenance costs continue to become more critical.

Test Procedure

The Norwegian Oil Industry Association in collaboration with others has established a standard for the qualification of non-metallic sealing materials used in oilfield environments, designated NORSOK M-710. This standard is widely used by the oil and gas industry for screening and selection of polymeric materials for use in oilfield applications. The standard provides a testing protocol and sets acceptance criteria. In addition to setting baseline criteria, it suggests that service life be determined from an Arrhenius equation.

The Materials Engineering Research Laboratory Limited in Hitchin, Hertfordshire, UK, completed a long-term study (MERL JIP SOUR2) of the effects of sour environments on a variety of materials, including AvaSpire® PAEK.

Because the purpose of this work was to conduct a more aggressive and longer term test than required by the NORSOK M-710 standard, the test conditions were modified. The organic liquid component specified by the standard is a volumetric mixture containing 70 % heptane, 20 % cyclohexane, and 10 % toluene. This mixture is commonly called NORSOK oil and it was used as 60 % of the simulated production fluid. The aqueous liquid component specified is distilled water. For this program, the aqueous component consisted of water containing 15 % salt and it was used as 10 % of the simulated production fluid. The final component, the gas phase, is specified for sour service as 3 % carbon dioxide, 2 % H₂S and 95 % methane. For this program, the H₂S was increased to 20 % and nitrogen was used for the balance instead of the mixture of carbon dioxide and methane. The sweet service gas component used in this program was simply nitrogen. In both sweet and sour conditions, the simulated production fluid consisted of 60 % NORSOK oil, 10 % aqueous phase and 30 % gas phase. The M-710 protocol requires a pressure of 100 bar (1,450 psi). This program was done at a pressure of 20 to 30 bar (290 to 435 psi).

AvaSpire® AV-621 NT and AvaSpire® AV-621 CF30 were injection molded into test bars conforming to the dimensional requirements of ASTM D638 Type 1. These bars were weighed and measured prior to exposure. Tensile properties were determined on a representative sample prior to exposing the balance of the bars, which were aged in both sweet and sour simulated production fluids at 170 °C (338 °F), 200 °C (392 °F) and 215 °C (419 °C). The aging at 170 °C (338 °F) was continued for about 1 year, while the aging at the higher temperatures was done for about 45 days. In both cases, bars were removed at defined time intervals, cooled to room temperature, weighed, measured and tested for tensile properties according to ASTM D638.

Results

AvaSpire® AV-621 NT and AV-621 CF30 demonstrated robust performance in sweet and sour environments at 20 % H₂S at 170 °C (338 °F). Similar behavior was observed in sour environments at 200 °C (392 °F) and 215 °C (419 °F).

Weight and volume changes measured during the test are given in Table 11, and the changes are less than the maximum allowable by M-710 of 5 %. Figure 7.2 shows the tensile strength of AvaSpire® AV-621 NT after aging at 170 °C (338 °F) in both sweet and sour simulated production fluids. Figures 7.3 and 7.4 show this information for tensile elongation and tensile modulus, respectively. Figures 7.5 through 7.7 give the tensile strength, elongation, and modulus of AV-621 CF30 after similar aging.

Figures 7.8 through 7.10 show the tensile properties of AV-621 NT after aging in the sour environment at 200 °C (392 °F) and 215 °C (419 °F). Figures 7.11 through 7.13 show the tensile properties of AV-621 CF30 after aging in the sour environment at 200 °C (392 °F) and 215 °C (419 °F).

Due to inadequate chemical aging, it was not feasible to make statistically relevant service life predictions with this data. Negative slopes describing a decrease in properties with time could not be established for the materials at all temperatures, and the Arrhenius method for extrapolation of service life could not be applied with confidence. Linear regressions based on the 170 °C (338 °F) aging indicate that these materials offer robust performance in the highly sour environment. The predicted time to reach 50 % of initial properties is 5-17 years.

Conclusions

AvaSpire® AV-621 NT and AV-621 CF30 offer robust performance in sweet and sour environments at concentration of 20 % H₂S at 170 °C (338 °F). These products fulfill the NORSOK M-710 acceptance criteria for the sour aging in the described test environment. Service life predictions cannot be made because AvaSpire® PAEK properties did not degrade enough. The Arrhenius equation is only useful when a clear degradation versus time and temperature relationship is demonstrated during the duration of the test.

Table 7.12 Weight and volume change after aging

Simulated Production Fluid Type	Temperature [°C (°F)]	AV-621 NT	AV-621 CF30
Volume Change [%]			
Sweet	170 (338)	3.9	4.2
Sour	170 (338)	4.0	4.8
Sour	200 (392)	4.6	5.4
Sour	215 (419)	4.4	6.1
Weight Change [%]			
Sour	200 (392)	4.4	3.8
Sour	215 (419)	3.8	4.4

Figure 7.2 Tensile strength of AV-621 NT exposed at 170 °C (338 °F)

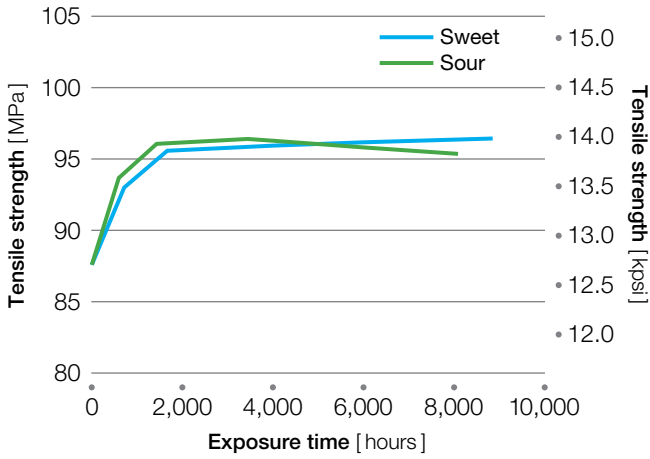

Figure 7.5 Tensile strength of AV-621 CF30 exposed at 170 °C (338 °F)

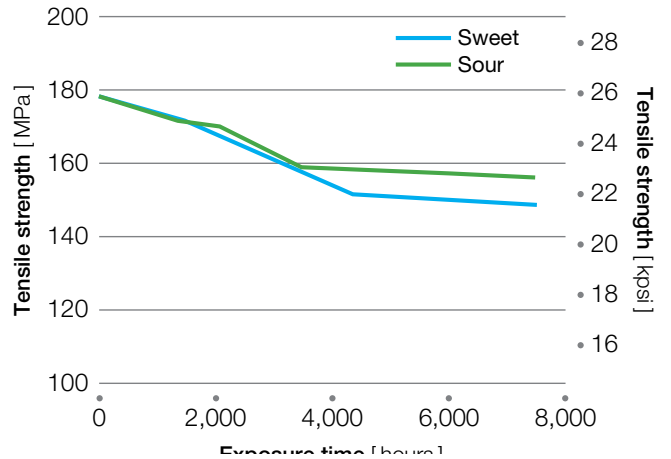

Figure 7.3 Tensile elongation of AV-621 NT exposed at 170 °C (338 °F)

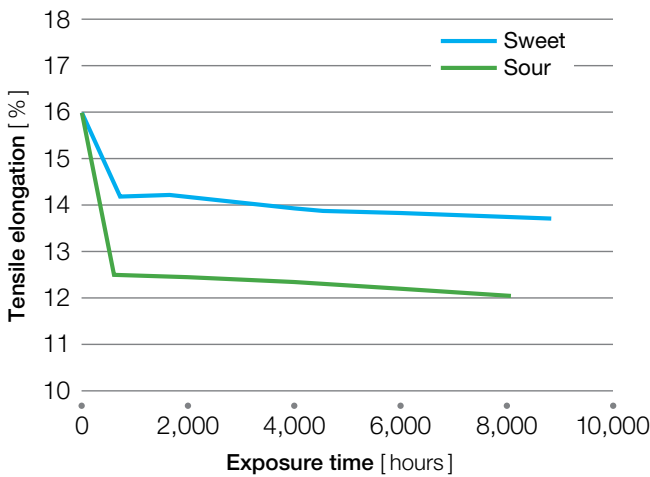

Figure 7.6 Tensile elongation of AV-621 CF30 exposed at 170 °C (338 °F)

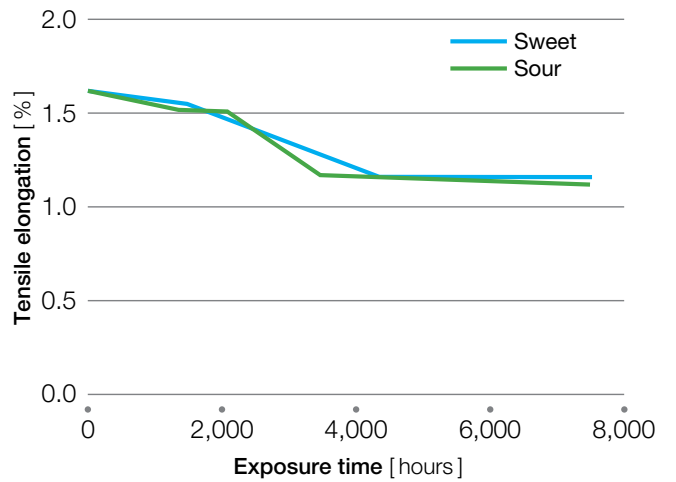

Figure 7.4 Tensile modulus of AV-621 NT exposed at 170 °C (338 °F)

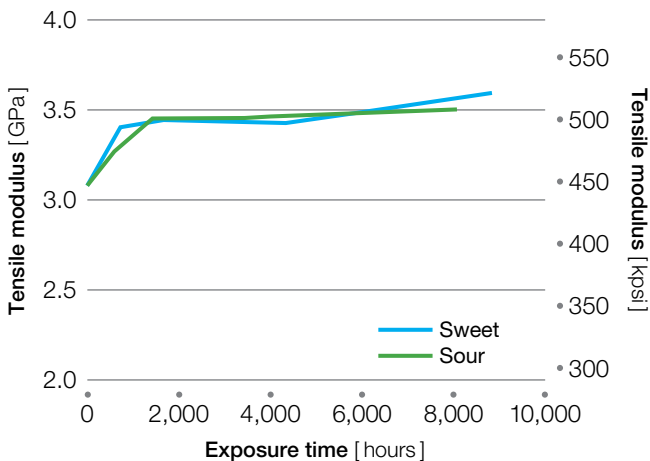

Figure 7.7 Tensile modulus of AV-621 CF30 exposed at 170 °C (338 °F)

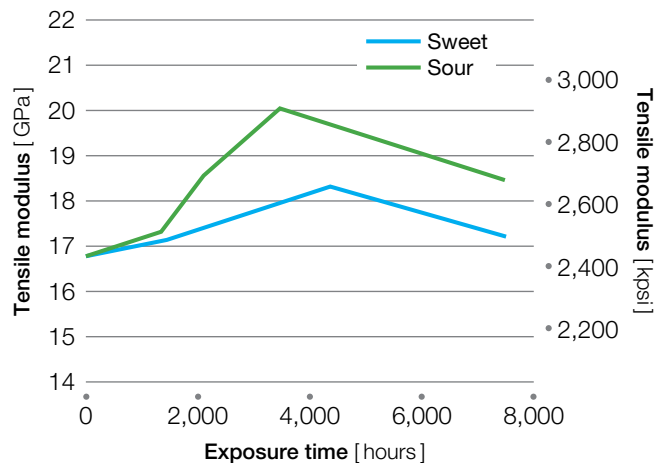

Figure 7.8 Tensile strength of AV-621 NT after high-temperature aging

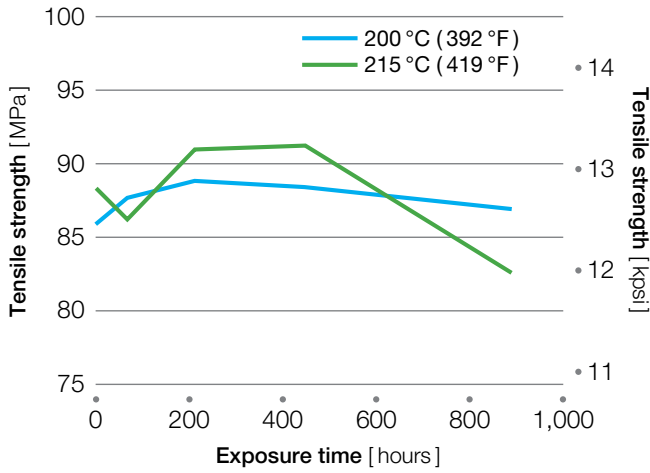

Figure 7.9 Tensile elongation of AV-621 NT after high-temperature aging

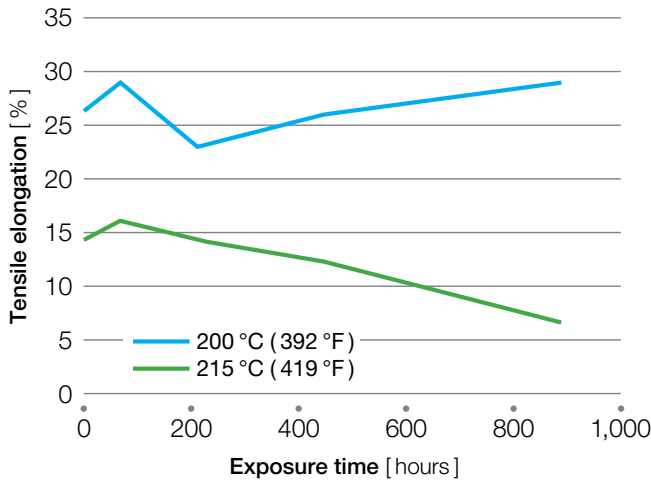

Figure 7.10 Tensile modulus of AV-621 NT after high-temperature aging

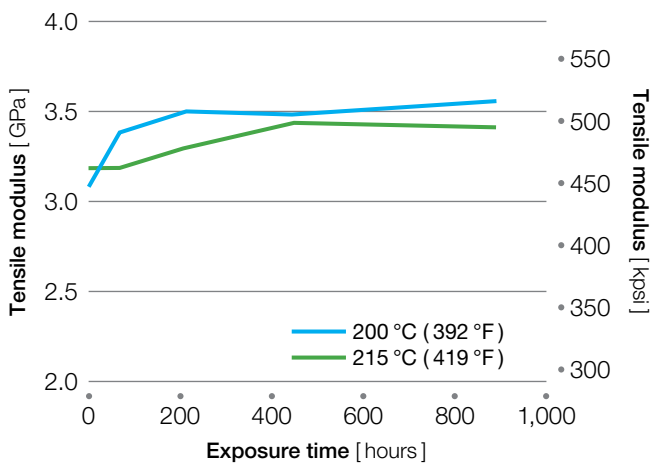

Figure 7.11 Tensile strength of AV-621 CF30 after high-temperature aging

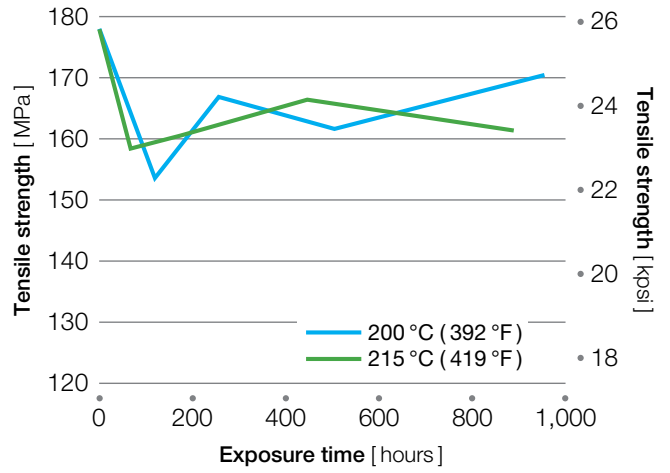

Figure 7.12 Tensile elongation of AV-621 CF30 after high-temperature aging

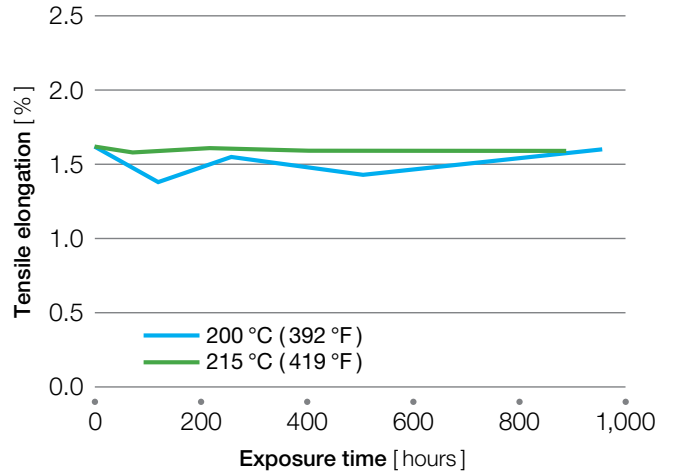
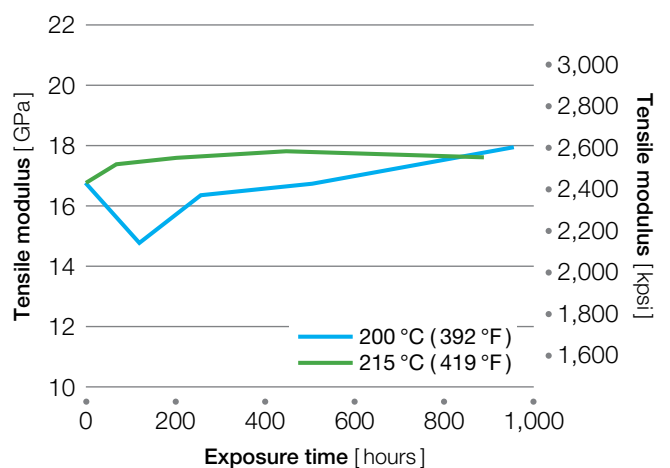

Figure 7.13 Tensile modulus of AV-621 CF30 after high-temperature aging



Sterilization Resistance

Several grades of AvaSpire® PAEK were tested for compatibility with a variety of sterilization techniques. In all cases, PAEK was exposed to multiple sterilizations or higher levels of the sterilizing agent to verify compatibility for repeated use. The techniques investigated include gamma radiation, electron beam (E-beam), ethylene oxide, vaporized hydrogen peroxide plasma (VHP), and steam autoclaving. None of these techniques resulted in any serious loss of properties for any of the grades tested. AvaSpire® PAEK can be considered compatible with all of the common sterilization methods.

Gamma Radiation

Gamma Radiation is an effective low-temperature sterilizing method. Gamma processing is a highly reliable procedure, that penetrates deep leaving no area with uncertain sterility.

Gamma rays are emitted from radioactive materials such as Cobalt 60 and Cesium 137. The product being sterilized is placed near the radiation source until the required dose is absorbed.

Two grades of AvaSpire® PAEK were evaluated for gamma sterilization suitability. Injection molded samples were sent to a firm that specializes in contract sterilization. Some samples were exposed to gamma radiation until they adsorbed 20 kGy, and some until they adsorbed 40 kGy. The properties of the exposed samples were measured and compared to unexposed samples. The results are shown in Table 7.13 for the 40 kGy samples. Even at this high dose, there is essentially no loss of properties.

Table 7.13 Property retention after 40 kGy gamma radiation exposure

Property	AvaSpire® AV-651 BG15	AvaSpire® AV-651 GF30 BG20
Tensile strength [%]	100	101
Tensile elongation at break [%]	67	93
Tensile modulus [%]	100	110
Dynatup max load [%]	98	104
Dynatup max energy [%]	96	112
Dynatup total energy [%]	99	115

Test procedures

After irradiation, the samples were conditioned according to ASTM D618 and tensile properties were measured according to ASTM D638. The unfilled grade, AV-651 NT15, was tested at a crosshead speed of 50 mm/min (2 in./min) and the glass-fiber reinforced grade, AV-651 GF30 NT20, was tested at a crosshead speed of 5 mm/min (0.2 in./min). Instrumented impact testing (Dynatup) was performed according to ASTM D3763.

Electron Beam

Electron beam sterilization, commonly called E-beam sterilization, is a commercially successful technology for sterilizing disposable medical devices. E-beam sterilizes by the same mechanism as gamma radiation and the dose requirements are similar. AvaSpire® AV-651 BG15 was evaluated for E-beam resistance and the results are shown in Table 7.14. The typical dose for sterilization is about 25 kGy and this test was run at about 10 to 20 times the normal dose. The PAEK was essentially unaffected even at this high dose level. The tensile elongation at break at the highest dose was reduced, but it is still in the ductile range and the other properties measured are unchanged.

Table 7.14 Effect of E-beam radiation on mechanical properties of AvaSpire® AV-651 BG15

Property	E-Beam Dose		
	0 kGy	240 kGy	480 kGy
Tensile strength [MPa (kpsi)]	88 (12.8)	89 (12.9)	88 (12.8)
Tensile modulus [GPa (kpsi)]	3.18 (462)	3.32 (482)	3.16 (459)
Tensile elongation at yield [%]	6.4	6.3	6.4
Tensile elongation at break [%]	86	85	32

Test procedures

Test specimens conforming to ASTM D638 Type 1 were treated with E-beam radiation at 240 and 480 kGy doses. After radiation, the samples were conditioned according to ASTM D618 and tested using ASTM test method D638.

Ethylene Oxide

Ethylene oxide (ETO) sterilization is commonly used to sterilize objects sensitive to temperatures greater than 60 °C (140 °F) such as optics and electronics. Ethylene oxide is an alkylating agent that disrupts the DNA of microorganisms, which prevents them from reproducing. It can kill all known viruses, bacteria, and fungi, including bacterial spores. However, it is highly flammable, toxic and carcinogenic. The resistance of AvaSpire® AV-650 BG15 was evaluated by exposing samples to 100 cycles of ETO sterilization and pulling samples periodically. The results are shown in Table 7.15. The properties after 100 cycles are essentially the same as unexposed samples.

AvaSpire® AV-650 BG15 has been discontinued and AV-651 BG15 is the suggested improved replacement.

Table 7.15 Effect of ethylene oxide on AvaSpire® AV-650 BG15

Property	Control	After 100 Cycles
Tensile strength [MPa (kpsi)]	81 (11.7)	83 (12.0)
Tensile elongation at break [%]	99	85
Tensile modulus [GPa (kpsi)]	2.72(395)	2.78 (404)
Dynatup impact		
Max load [N (lb)]	6,720 (1,510)	7,160 (1,610)
Energy at max load [J (ft-lb)]	62 (46)	68 (50)
Total energy [J (ft-lb)]	69 (51)	74 (54)

Test procedures

Test samples conforming to ASTM D638 Type 1 and plaques 100 x 100 x 3 mm (4 x 4 x 0.12 in.) were sterilized. The conditions for the ETO sterilization were ETO concentration of 883 mg/L, temperature of 55 °C (131 °F), exposure time of 60 minutes, relative humidity of 70 %, and aeration time of 60 minutes. After the desired number of cycles, the samples were removed, cooled to room temperature, conditioned according to ASTM D618. Tensile properties were tested according to ASTM D638. The impact testing was done according to ASTM D3763.

Low-Temperature Hydrogen Peroxide Sterilization

Another alternative for low-temperature sterilization is hydrogen peroxide gas. In this process a concentrated aqueous solution of hydrogen peroxide (H₂O₂) is vaporized and injected into an evacuated chamber containing devices. This gas diffuses through the chamber exposing all of the surfaces to be sterilized. After a final venting step, devices are ready to use as no aeration is needed.

Two grades of AvaSpire® PAEK were tested, unfilled AV-651 BG15 and glass fiber reinforced AV-651 GF30 BG20. The results of the evaluation are summarized in Table 7.16. None of the AvaSpire® grades tested show any degradation of properties after 200 cycles. The only change seen was in the color of the samples. For more detailed information about this study, please visit the Solvay Specialty Polymers website.

Table 7.16 Effect of VHP sterilization

Property	AvaSpire® AV-651 BG15		AvaSpire® AV-651 GF30 BG20	
	0 Cycles	200 Cycles	0 Cycles	200 Cycles
Tensile strength [MPa (kpsi)]	89 (12.9)	90 (13.1)	153 (22.2)	155 (22.5)
Tensile modulus [GPa (kpsi)]	3.2 (464)	3.1 (450)	10.4 (1508)	10.0 (1450)
Elongation at break [%]	59	56	3.1	3.5
Flexural strength [MPa (kpsi)]	128 (18.6)	130 (18.9)	251 (36.4)	258 (37.4)
Flexural modulus [MPa (kpsi)]	3.2 (464)	3.3 (479)	9.5 (1378)	10 (1450)
Dynatup impact				
Energy at maximum load [N (lb)]	6,160 (1,385)	6,350 (1,428)	1,440 (324)	1,380 (311)
Total energy [J (ft-lb)]	62 (46)	70 (52)	11 (8)	11 (8)
Color retention [Δ E]		2.5		3.1

Test procedures

Injection molded tensile bars conforming to ASTM D638 Type 1, bars 127 x 12.7 x 3.2 mm (5 in. x 0.5 in. x 0.125 in.) conforming to ASTM D790, and plaques 100 x 100 x 3 mm (4 x 4 x 0.12 in.) of each grade were sent to an equipment manufacturer for gas plasma sterilization

Sterilization was performed via gas plasma hydrogen peroxide sterilization in a STERRAD® 100NX® sterilization system. The samples were placed on edge and separated to maximize sterilant exposure around each sample. The prepared trays were then double wrapped with polypropylene CSR wrap. The trays were placed on both shelves of the STERRAD® 100NX® sterilization chamber and processed using the standard cycle. The test samples were processed for 25 cycles, 100 cycles, and 200 cycles with approximately 30 minutes or longer rest between cycles. Every 10 cycles the samples were wiped down with a lint free wipe moistened with deionized water and allowed to dry before continuing.

Samples were returned and mechanical property testing was conducted in Solvay’s Test Labs in Alpharetta, GA. Samples were conditioned according to ASTM D618 prior to testing. Tensile properties were tested according to ASTM D638, flexural properties according to D790, and impact testing according to ASTM D3763.

Steam Autoclaving

Steam autoclaving is a fast, reliable, and inexpensive method of sterilizing. Table 7.17 shows the effects of steam autoclaving for 1,000 cycles on AvaSpire® AV-621 NT and AV-651 BG15. Tensile strength, tensile modulus, and impact resistance are not diminished by 1,000 cycles of steam sterilization. In fact, some slight increases in strength are seen. Elongation at break is reduced, but it is still high enough to show that the material has not lost its ductility.

Table 7.17 Effect of steam sterilization

Property	AvaSpire® AV-621 NT		AvaSpire® AV-651 BG15	
	Cycles			
	0	1,000	0	1,000
Tensile strength at yield [MPa (kpsi)]	85 (12.3)	93 (13.5)	81 (11.7)	92 (13.3)
Elongation at yield [%]	6.3	5.4	6.1	4.7
Elongation at break [%]	50	32	91	36
Tensile modulus [GPa (kpsi)]	3.1 (451)	3.2 (463)	3.0 (428)	3.1 (451)
Dynatup Impact				
Max load [N (lb)]	6,320 (1,420)	6,660 (1,500)	6,040 (1,360)	6,260 (1,410)
Max energy [J (ft-lb)]	59 (44)	61 (45)	56 (41)	58 (43)
Total energy [J (ft-lb)]	71 (52)	73 (54)	61 (45)	66 (49)

Table 7.18 Steam autoclave sterilization conditions

Equipment	Amsco® Century® Sterilizer SV-136H
Cycle	Pre-vac
Temperature	134 °C (273 °F)
Pressure	2.1 – 2.3 bar (31 – 33 psi)
Vacuum	686 mm Hg (27 in. Hg)
Sterilization time	18 minutes/cycle
Drying time	10 minutes/cycle
Conditioning time	5 minutes/cycle
Total time	33 minutes/cycle

Table 7.19 UV spectral power distribution for Xenon arc with daylight filters

Spectral Bandpass Wavelength λ [nm]	Minimum [%]	Maximum [%]
$\lambda < 290$		0.15
$290 \leq \lambda \leq 320$	2.6	7.9
$320 \leq \lambda \leq 360$	28.3	40.0
$360 \leq \lambda \leq 400$	54.2	67.5

Test procedures

Injection molded tensile bars conforming to ASTM D638 Type 1 and plaques 100 x 100 x 3 mm (4 x 4 x 0.12 in.) were subjected to steam autoclave sterilization at the conditions shown in Table 7.18. Samples were removed after 250, 500, and 1,000 sterilization cycles. Samples were conditioned according to ASTM D618 prior to testing. Tensile properties were tested according to ASTM D638 using a testing speed to 50 mm/min (2 in./min). The impact testing was done according to ASTM D3763.

Table 7.20 Color change after 8,000 hours exposure

Parameter	AvaSpire® AV-651 BG15	AvaSpire® AV-651 GF30 BG20	AvaSpire® AV-750 GF40
	Initial value L	72.6	80.1
ΔL	- 0.6	- 8.7	- 0.9
Initial value a	1.4	0.4	3.5
Δa	2.6	9.5	7.5
Initial value b	5.8	9.2	9.2
Δb	23.1	31.7	17.1
ΔE	23.2	34.2	18.7

Weathering

Most materials are affected by exposure to weather. The effects of exposure of high levels of ultraviolet radiation such as found in sunlight were evaluated using an Atlas water-cooled weathering test instrument using a Xenon arc light.

Test Method

Test specimens conforming to ASTM D638 Type 1 and plaques for color measurement were exposed in a Ci4000 Xenon Weather-Ometer® for up to 8,000 hours. The size of the plaques was 50 x 75 x 2 mm (2 x 3 x 0.079 in.).

The exposure was performed according to cycle 1 of ASTM G 155. Cycle 1 consists of 102 minutes of light with a black panel temperature of 63 °C (145 °F) followed by 18 minutes of light and water spray. The daylight filter was used to simulate terrestrial sunlight exposure. The specification for spectral power distribution for Xenon arc with daylight filters is shown in Table 7.19. The Xenon arc irradiance level was 0.35 W/m²-nm at a wavelength of 340 nm. Periodically specimens were removed and tested for tensile strength, modulus, and elongation according to ASTM test method D 638. The specimens were also visually inspected for appearance and the color was measured using a BYK Gardner spectrophotometer according to ASTM E1164.

Results

Appearance and color

The color measurements are shown in Table 7.20. The parameters shown correspond to CIE (International Commission on Illumination) standard practices. The L value shows position on the light/dark scale. Positive ΔL indicates the sample has gotten lighter. The a value shows position on the red/green axis. Positive Δa indicates redder. The b value shows position on the yellow/blue axis. Positive Δb indicates yellower. ΔE is the square root of the sum of ΔL squared + Δa squared + Δb squared. If ΔE is very low, < 2, then the two colors are a match or are very close. Large ΔE values indicate large color differences.

The values in Table 7.19 show that there was significant color change for three AvaSpire® PAEK grades. The data indicate that the color of the bars became yellower and darker. In addition, a loss of gloss was seen by visual inspection.

Color measurements on AvaSpire® AV-722 BG20 are not available at this time, but visual inspection of exposed bar indicated yellowing and loss of gloss similar to the other grades.

Mechanical properties

AvaSpire® AV-651 and AV-722 are ductile polymers and specimens tested for tensile strength exhibit a yield point before breaking. AvaSpire® AV-651 GF30 and AV-750 GF40 are reinforced grades and they do not yield.

Unlike PEEK, AvaSpire® AV-651 and AV-722 PAEK retain much of their ductility after weathering. As shown in Figure 7.14, both of these materials after 8,000 hours still have yields strengths greater than 95 % of the unexposed value.

Another measure of ductility is the elongation, both at yield and at break. Typically when a material becomes brittle, the samples break before yielding and the elongation at break is reduced. Figure 7.15 shows the change in elongation at yield as a function of hours of exposure. Both grades continue to show a yield point even after 8,000 hours of simulated weathering.

Figure 7.14 Tensile strength at yield

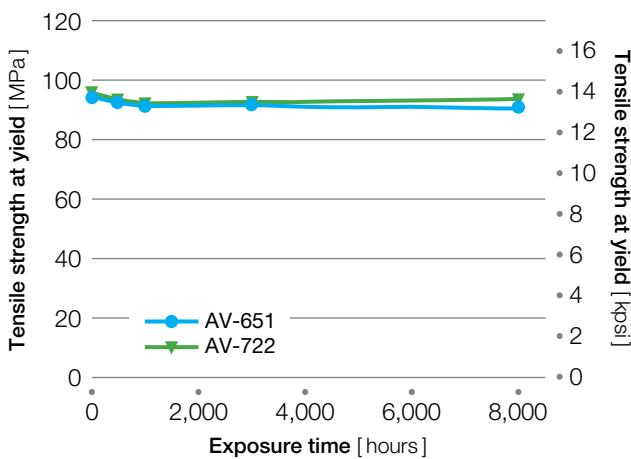

Figure 7.15 Tensile elongation at yield

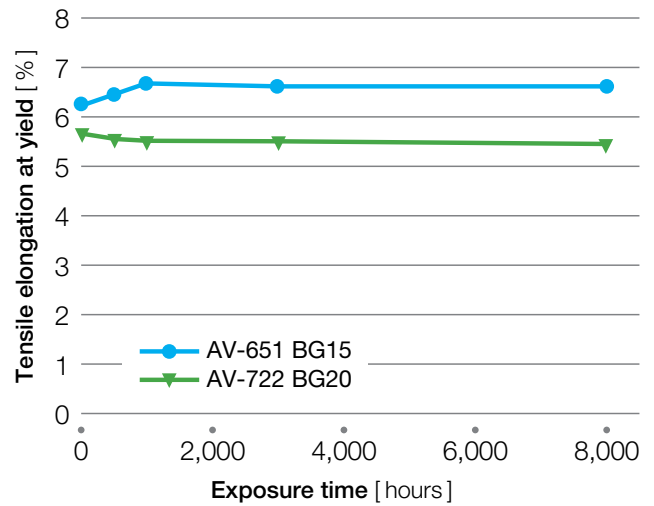

Figure 7.16 Tensile modulus

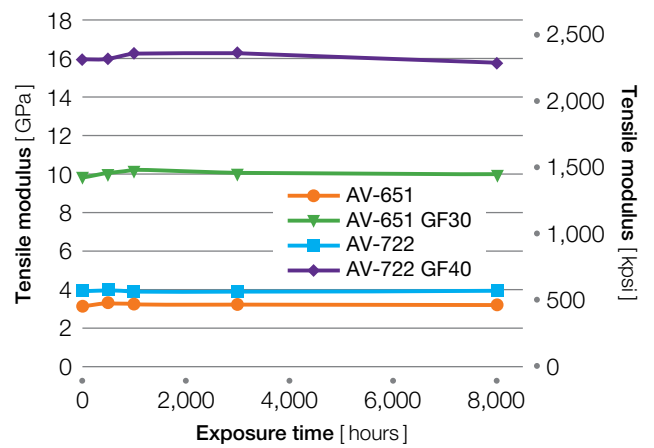
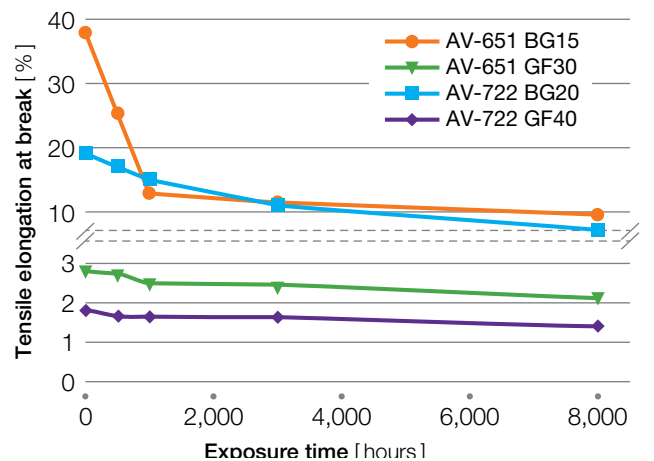

Figure 7.17 Tensile elongation at break



Conclusions

The four AvaSpire® PAEK grades tested, AV-651 BG15, AV-651 GF30 BG20, AV-722 BG20, and AV-750 GF40 NT, showed better retention of mechanical properties than PEEK. They retain some ductility even after 8,000 hours of exposure.

All grades showed significant yellowing. Therefore, for appearance applications that will be exposed to direct sunlight, it is recommended that parts be painted or pigmented black. If appearance is not critical, AvaSpire® PAEK has sufficient resistance to weathering for many applications.

Water Absorption

Since moisture is ubiquitous, knowledge of the effects of moisture on the properties of a material is critical to the design engineer trying to meet end-use requirements. While the mechanical properties of metals are essentially unaffected by short-term exposure to water, the response of plastics varies considerably depending on the polymer chemistry. PAEK resins do not absorb much water and the absorbed water has little effect on the mechanical properties of the resin.

To measure the amount of moisture that AvaSpire® PAEK would absorb, weighed specimens 3.2 x 12.7 x 127 mm (0.125 x 0.5 x 5 in.) were immersed in de-ionized water at room temperature. At weekly intervals, some specimens were removed and weighed. The change in weight was ascribed to water absorption and the percent change was calculated. Figure 7.19 shows the weight change for unfilled AvaSpire® AV-621 NT PAEK and Figure 7.20 shows the weight change for AvaSpire® AV-621 GF30 which is 30 % glass-fiber reinforced PAEK.

Steam autoclave studies show the properties of AvaSpire® AV-621 PAEK are not affected by 1,000 cycles of pressurized steam at elevated temperature.

The available data indicate that the design engineer does not need to be concerned with water absorption when designing with AvaSpire® AV-621 PAEK, even if the exposure is at elevated temperatures.

AvaSpire® AV-848 NT appears to be reaching an equilibrium level of about 1.5 %. While this value is higher than the AV-621 NT, it is still low compared to many polymers and no deleterious effects have been identified.

Figure 7.18 Water absorption of AvaSpire® AV-621

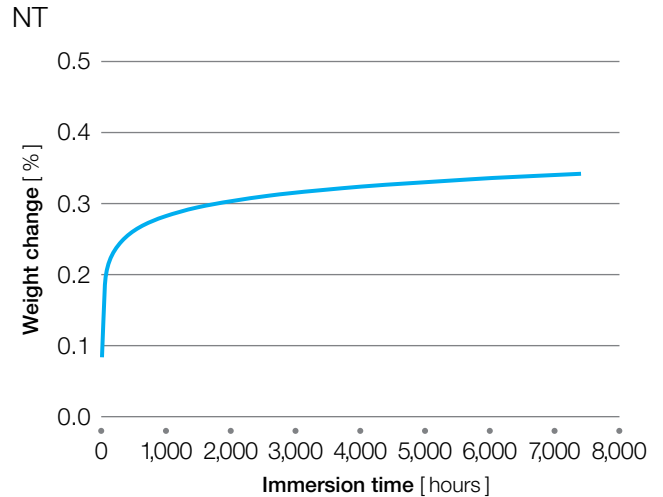

Figure 7.19 Water absorption of AvaSpire® AV-621 GF30 BG20

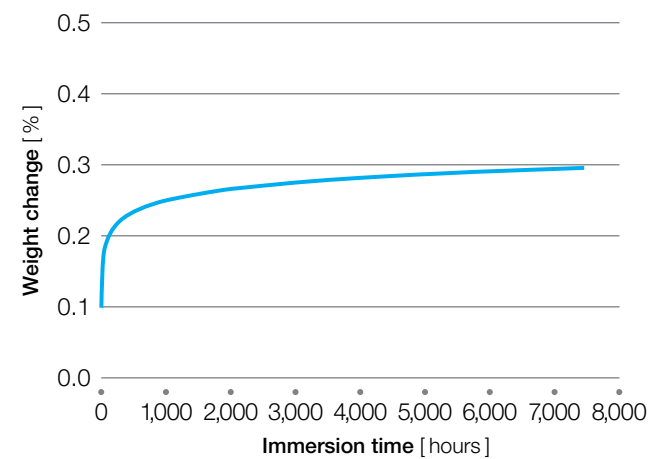
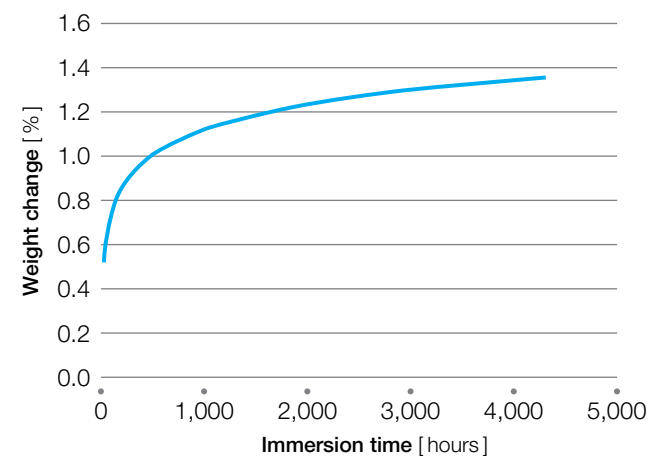

Figure 7.20 Water absorption of AvaSpire® 848 NT



Design Principles

In this document, basic design principles and general recommendations are presented to assist design engineers in designing components using AvaSpire® polyaryletherketone (PAEK) that meet the cost/performance requirements of their applications. Guidelines are given on the effects of stresses caused by assembly, temperature changes, environmental factors, and time as it relates to creep.

Ultra-performance polymers, such as AvaSpire® PAEK, are ideal candidates for metal-to-plastic conversion due to their superior mechanical and thermal properties and higher specific strength. For many applications, weight reduction has many benefits, such as reduced friction, lower energy usage, lower dynamic stress on the assembly, and lower system cost.

The concept of material efficiency can be illustrated by calculating specific strength and modulus. Specific strength is the material's strength divided by its density and can be related to the weight of material required to support a load. Table 8.1 lists the specific strength and modulus of several common metals and selected grades of AvaSpire® PAEK; specific strength data is graphed in Figure 1. Specific strength can be used to compare the mass of material required to support a load. For example, AvaSpire® AV-621 GF30 has a specific strength of 95 kNm/kg (385 klpf-in/lb) and carbon steel's is 35 kNm/kg (140 klpf-in/lb), suggesting that for equivalent strength the PAEK part would weigh about 37 % of the weight of the steel part.

For a successful conversion it is highly desirable to understand the differences between metals and plastics and the design flexibility of injection molding.

At times, designing with plastics may appear more complicated than with metals. But the diversity of products, conversion processes, and secondary operations (welding, inserts, printing, painting, metalizing) that are available with plastics give the designer unprecedented freedom.

Figure 8.1 Specific strength comparison

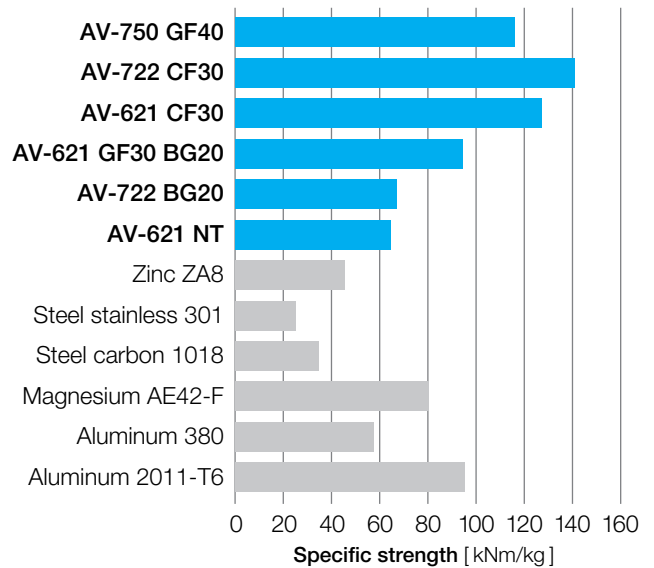

A designer may be tempted to make a PAEK part that merely duplicates the dimensions of a metal part without taking advantage of the versatility of the material or the design freedom offered. This approach can lead to inefficient designs, parts that are difficult to produce, or parts with less than optimal performance.

The following sections discuss those areas of mechanical design and stress analysis that relate to designing with plastics, comparing metal to plastics and discussing factors that are specific to plastics alone.

Mechanical Design

The use of classical stress and deflection equations may provide starting points for part design. Mechanical design calculations for AvaSpire® PAEK will be similar to those used with any engineering material. As with all plastics, however, the analysis used must reflect the viscoelastic nature of the material. In addition, the material properties can vary with strain rate, temperature, and chemical environment or with fiber orientation for fiber-reinforced plastics. Therefore, the analysis must be appropriate for all anticipated service conditions. For example, if the service condition involves enduring load for a long period of time, then the apparent or creep modulus should be used instead of the short-term elastic modulus. If the loading is cyclical and long term, the fatigue strength at the design life will be the limiting factor.

The initial step in any part design analysis is the determination of the loads to which the part will be subjected and calculation of the resultant stress and deformation or strain. The loads may be externally applied or result from stresses due to temperature changes or assembly.

An example of an externally applied load is the weight of medical instruments on a sterilizer tray. Examples of assembly loads are the loads on a housing flange when it is bolted to an engine or the load on the hub of a pulley when a bearing is pressed into it. Thermally induced stresses can arise when the temperature of the assembly increases and the dimensions of the plastic part change more or less than the metal part to which it is attached.

Using Classical Stress-Strain Equations

To use the classical equations, the following simplifying assumptions are necessary:

- The part can be analyzed as one or more simple structures
- The material can be considered linearly elastic and isotropic
- The load is a single concentrated or distributed static load gradually applied for a short time
- The part has low residual or molded-in stresses

While all of these assumptions may not be strictly valid for a particular situation, the classical equations can provide a starting point for analysis. The design engineer can then modify the analysis to take into consideration the effects of the simplifying assumptions.

A variety of parts can be analyzed using a beam bending model. Figure 8.2 lists the equations for maximum stress and deflection for some selected beams.

The maximum stress (σ) occurs at the surface of the beam furthest from the neutral surface and is given by:

$$\sigma = \frac{Mc}{I} = \frac{M}{Z}$$

Where:

M = Bending moment, Nm (lbf-in)

c = Distance from neutral axis, m (in)

I = Moment of inertia, m⁴ (in⁴)

Z = $\frac{I}{c}$ = Section modulus, m³ (in³)

Figure 8.3 gives the cross-sectional area (A), the moment of inertia (I), the distance from the neutral axis (c), and the section modulus (Z) for some common cross sections. For other cross sections and/or geometries, the design engineer can consult stress analysis handbooks or employ finite element analysis.

Table 8.1 Specific strength and modulus of common metals and AvaSpire® PAEK

Material	Density [g/cm ³]	Tensile Strength [MPa (kpsi)]	Specific Strength [kNm/kg (klbf-in/lb)]	Tensile Modulus [GPa (kpsi)]	Specific Modulus [MNm/kg (Mlbf-in/lb)]
Aluminum 2011-T6	2.83	270 (39.2)	95 (383)	70.0 (10,200)	24.7 (99.3)
Aluminum 380	2.76	159 (23.1)	58 (231)	71.0 (10,300)	25.7 (103.3)
Magnesium AE42-F	1.80	145 (21.0)	81 (323)	45.0 (6,500)	25.0 (100.4)
Steel carbon 1018	7.87	275 (39.9)	35 (140)	205.0 (29,700)	26.0 (104.6)
Steel stainless 301	8.03	205 (29.7)	26 (102)	212.0 (30,700)	26.4 (106.0)
Zinc ZA8	6.30	290 (42.1)	46 (185)	86.0 (12,500)	13.7 (54.8)
AvaSpire® PAEK					
AV-621 NT	1.29	84 (12.2)	65 (261)	3.0 (440)	2.3 (9.3)
AV-722 BG20	1.32	89 (12.9)	67 (271)	3.8 (550)	2.9 (11.6)
AV-621 GF30 BG20	1.55	147 (21.3)	95 (381)	10.0 (1,450)	6.5 (25.9)
AV-621 CF30	1.42	181 (26.3)	127 (512)	17.2 (2,490)	12.1 (48.6)
AV-722 CF30	1.42	200 (29.0)	141 (565)	22.0 (3,190)	15.5 (62.2)
AV-750 GF40	1.65	191 (27.7)	116 (465)	15.1 (2,190)	9.2 (36.7)

Figure 8.2 Maximum stress and deflection equations

Simply supported beam
Concentrated load at center

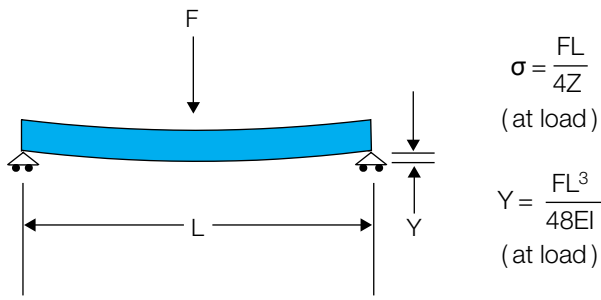

Cantilevered beam (one end fixed)
Concentrated load at free end

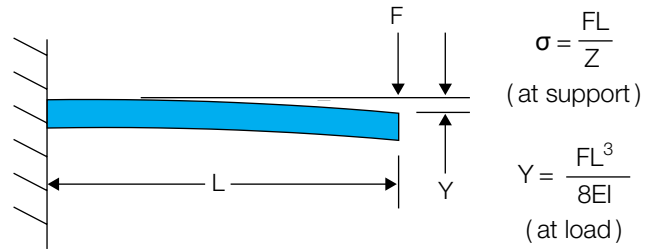

Simply supported beam
Uniformly distributed load

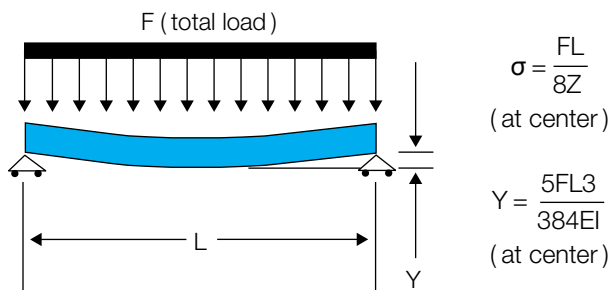

Cantilevered beam (one end fixed)
Uniformly distributed load

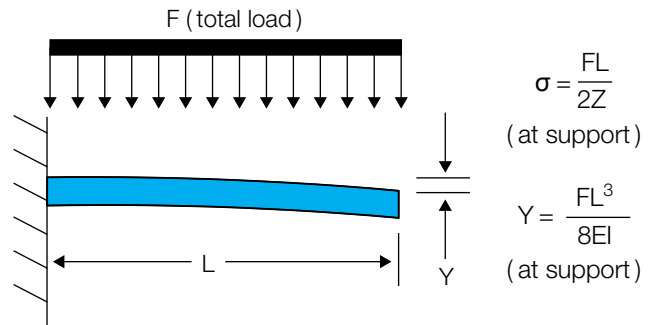

Both ends fixed
Concentrated load at center

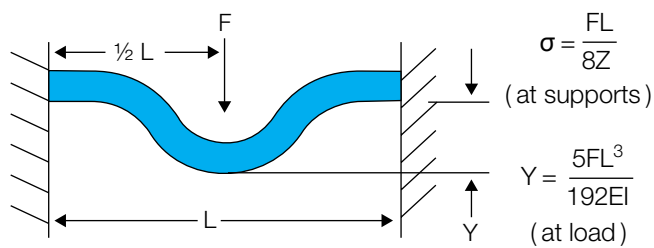

Both ends fixed
Uniformly distributed load

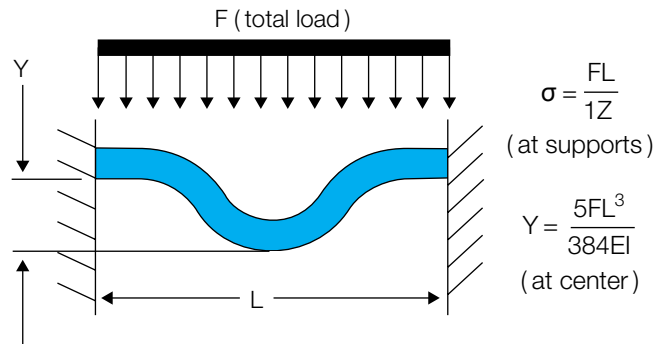
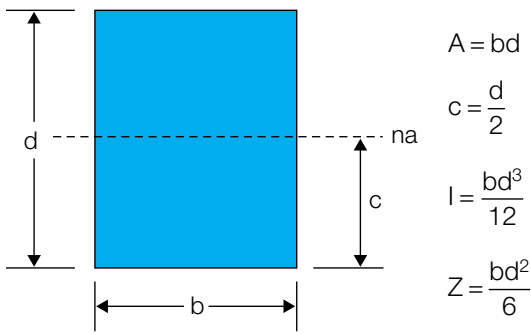
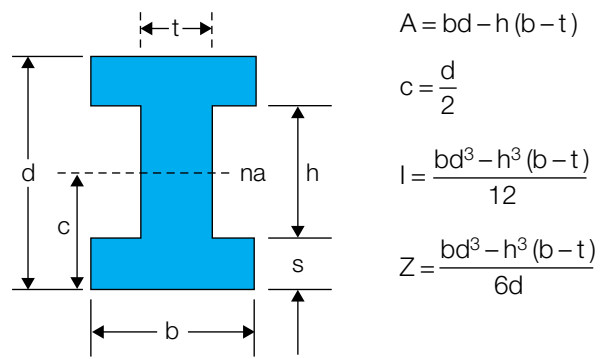

Figure 8.3 Area and moment equations for selected cross sections

Rectangular



I-beam



Circular

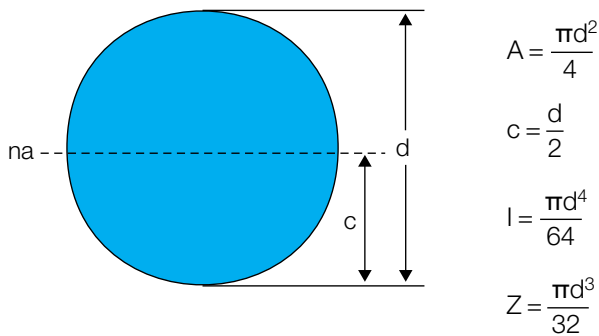

H-beam

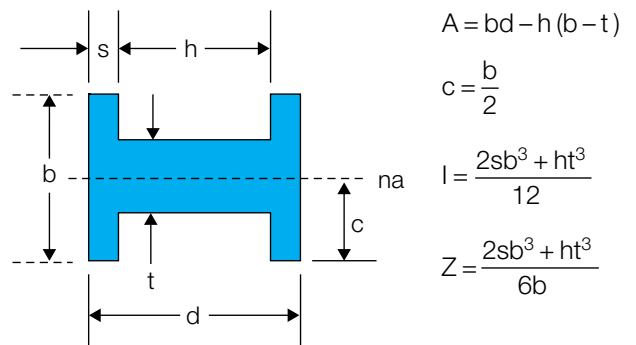

Tube

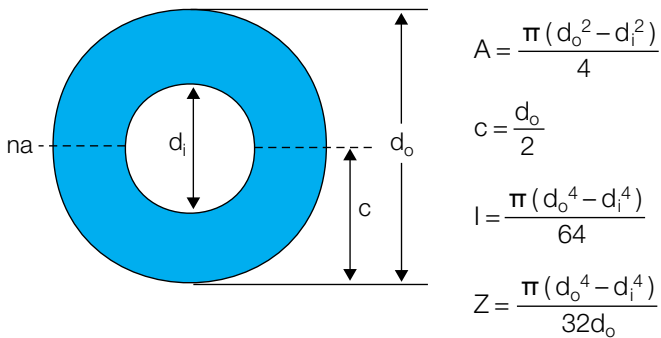

Hollow rectangular

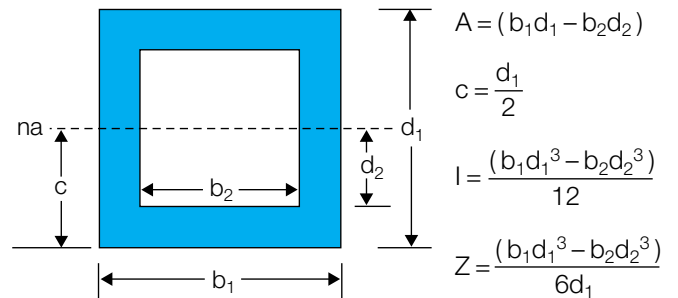

T-beam or rib

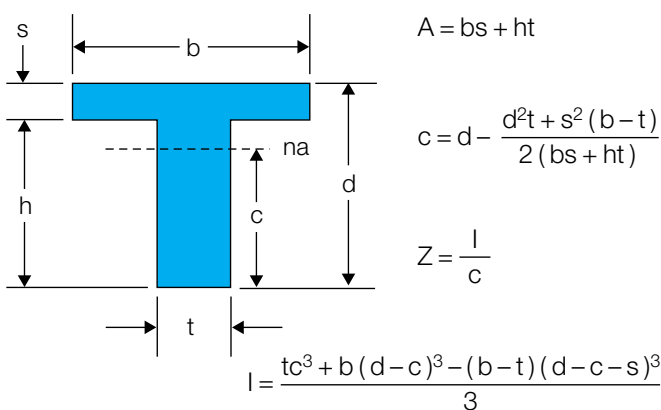

U-beam

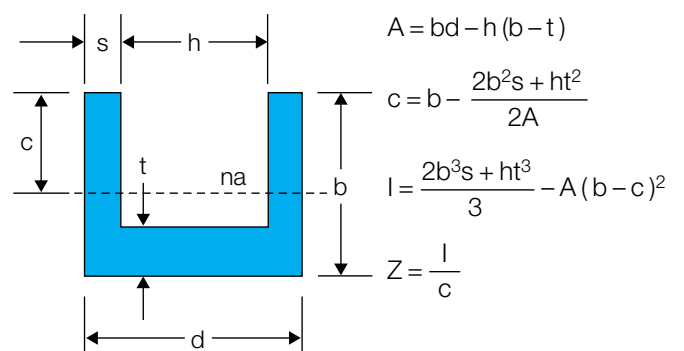

Limitations of Design Calculations

For stress calculations, the application of the classical mechanical design equations are useful as starting points, but some critical factors are simply not adequately considered by these analyses. The viscoelastic behavior of polymeric materials limits application of some of the design equations to, for example, low deflection cases. Often the calculation of maximum stress contains a number of simplifying assumptions.

Also, the impact resistance of a design is directly related to its ability to absorb impact energy without fracture. It is difficult to predict the ability of a design to absorb energy. In addition, even armed with the energy absorption requirements, practical toughness constants for engineering resins don't exist. The results of laboratory testing vary with the type and speed of the impact test, even for fixed geometries. Therefore, the ability of the design to withstand impact must be checked by testing the impact of prototype parts.

Similarly, fatigue test results will vary depending on the cyclic rate chosen for the test, the dynamics of the test, and the test specimen used. Therefore, they should only be used as a rough indication of a material's ability to perform in a fatigue application.

Deflection Calculations

To determine the deflection of a proposed part design using classical equations, a modulus of elasticity value is required. It is important that the appropriate value be used. The value must represent the modulus of the material at or near the temperature and humidity expected in the application. Room and elevated temperature values can be found in the property tables. If the load is sustained, then the apparent or creep modulus should be used. Please contact your Solvay representative for details.

Stress Calculations

After the designer has calculated the maximum stress, the value is then compared to the appropriate material property, i.e., tensile, compressive, or shear strength. The comparison should be appropriate in terms of temperature and humidity to the requirements of the application.

To illustrate the use of the equations in Figures 8.2 and 8.3, the following examples are presented.

The case chosen for the examples is a cantilever beam with one end fixed and a concentrated load at the free end as shown in Figure 8.4.

Figure 8.4 Beam used for examples

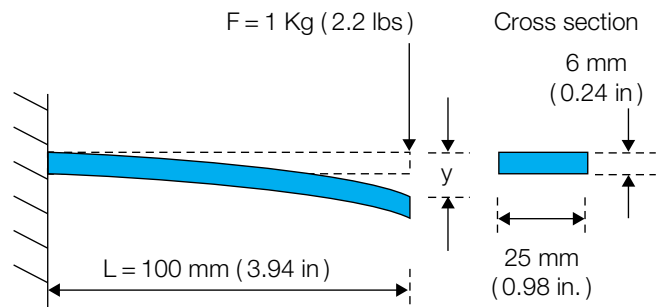

From Figure 8.2, for a cantilevered beam with rectangular cross section, the deflection is given by:

$$Y = \frac{FL^3}{3EI}$$

Where:

Y = Deflection

F = Force on the free end of the beam

L = Length of the cantilever

E = Modulus of the beam material

I = Moment of inertia of the beam

From Figure 8.3, the moment of inertia of a rectangular cross section is given by:

$$I = \frac{bd^3}{12}$$

Where:

I = The moment of inertia

b = Width of the beam

d = Thickness of the beam

For the beam shown in Figure 8.4:

$$\text{The moment of inertia} = \frac{25 \times 6^3}{12} = 450 \text{ mm}^4$$

To calculate the deflection, a value for E, the modulus, is required. In this case, the beam will bend under load and the most appropriate modulus is the flexural modulus. Values for the flexural modulus of AvaSpire® PAEK grades can be found in the Typical Properties Tables or the product data sheets on our website at www.specialtypolymersdatasheets.com. There are two values of flexural modulus shown for each grade, one obtained by testing according to ASTM D790 and one obtained by testing according to ISO 178. Although these test methods measure the same property, they vary in some of the details, and the values obtained are not identical. For this exercise, the value obtained by ISO 178 was arbitrarily chosen.

For this example, the deflection at room temperature will be calculated for AV-651 BG15, the high-flow, unreinforced grade.

The value for flexural modulus by ISO 178 is 3.20 GPa. Assuming a load of 1 kg on the free end, the force becomes 9.8 N. Substituting these values into the deflection equation:

$$Y = \frac{(1 \text{ kg} \times 9.8)(0.1 \text{ m})^3}{3(3.90 \text{ GPa})(450 \text{ mm}^4)} = 2.27 \text{ mm (0.089 in)}$$

Repeating the calculation using the moduli of the glass-fiber reinforced and carbon-fiber reinforced grades, the deflections are shown in Table 8.2.

Table 8.2 Deflections for a 1 kg load on a cantilever beam

AvaSpire® Grade	Flexural Modulus by ISO 178 [GPa (kpsi)]	Deflection [mm (inch)]
AV-651 BG15	3.20 (460)	2.27 (0.089)
AV-651 GF30 BG20	9.70 (1,410)	0.75 (0.029)
AV-651 CF30	19.1 (2,770)	0.38 (0.015)

Table 8.2 shows that the calculated values for deflection are inversely proportional to the flexural modulus. The highest modulus AV-651 CF30 grade has the lowest deflection under this load or in other words has the greatest stiffness.

As stated previously, the properties of plastic materials are a function of the temperature at which they are measured. To provide guidance regarding the behavior at elevated temperatures, the modulus of AvaSpire® PAEK has been measured at several temperatures. The deflections at elevated temperature can be calculated by using these moduli.

For this example, AvaSpire® grades AV-621 NT and AV-621 GF30 BG20 were chosen, and the values of flexural modulus obtained using ASTM D790 were used.

The results of these calculations are shown in Table 8.3. Unfilled AvaSpire® PAEK resists serious deflection until the temperature exceeds 150 °C (302 °F). The calculated deflection at 200 °C (392 °F) indicates a serious loss of stiffness suggesting that the unfilled grade may not be suitable for highly stressed applications at 200 °C (392 °F). However, the glass-fiber reinforced grade continues to resist serious deflection even at 200 °C (392 °F).

Table 8.3 Deflection as a function of material and temperature

Temperature [°C (°F)]	Flexural Modulus [GPa (kpsi)]	Deflection [mm (inch)]
AV-621 NT		
23 (73)	3.28 (476)	2.21 (0.087)
100 (212)	2.98 (432)	2.44 (0.096)
150 (302)	2.63 (382)	2.76 (0.109)
200 (392)	0.58 (85)	12.52 (0.493)
AV-621 GF30 BG20		
23 (73)	8.96 (1,300)	0.81 (0.032)
100 (212)	8.40 (1,220)	0.86 (0.034)
150 (302)	7.90 (1,150)	0.92 (0.036)
200 (392)	2.44 (354)	2.98 (0.117)

Reinforcing Fiber Orientation Considerations

When designing with plastics, especially filled plastics, the designer must be cognizant of the effects of the fillers and reinforcing fibers on the mechanical properties of the plastic. The processing of filled plastics tends to cause orientation of fibers or high-aspect-ratio fillers parallel to the direction of flow.

Since the design of the part and the processing are interrelated, the designer should consider what portions of the part are likely to be oriented and how the properties will be affected. Shrinkage, strength, stiffness, and coefficient of thermal expansion will differ depending on the aspect ratio of the fiber (the ratio of its length to its diameter) and the degree of fiber orientation. Perpendicular to the fiber orientation, the fibers act more like fillers than reinforcing agents.

When molding polymers, there are instances where melt fronts meet (commonly known as weld lines) such as when the plastic melt flows around a core pin. However, the reinforcement in the plastic, if present, often does not cross the weld line. Thus, the weld line does not have the strength of the reinforced polymer and at times can even be less than the matrix polymer itself. These factors must be taken into account when designing parts with reinforced plastics.

Designing for Equivalent Part Stiffness

Sometimes, a design engineer wants to replace a metal part with one made of plastic, but still wants to retain the rigidity of the metal part. From Table 8.1, it is apparent that the modulus of the listed metals is much higher than the modulus of the polymers. Depending upon the polymer grade and the metal, the metal modulus is from 2 to 20 times higher than the polymer modulus at room temperature. When the temperature is increased, the modulus of the polymer will decrease, while the metal's modulus is essentially constant causing the ratio to become even higher.

According to structural mechanics, the deflection of the part is inversely proportional to modulus. That means the deflection of a plastic part would be greater than the deflection of a metal part in the same design. Naturally, the difference in modulus has to be managed to achieve the same deflection. It is easy to compensate for the modulus difference by changing the geometry of the part. Ribs offer a very economical way to stiffen the part. In short, it is essential to redesign a plastic part for a structural application.

There are two fairly simple ways to maintain the stiffness of a part when substituting one material with another material, even though the materials have different moduli of elasticity.

In the first method, the cross-sectional thickness is increased to provide stiffness. In the second, ribs are added to achieve greater stiffness. An example of each approach follows.

Changing section thickness

In reviewing the deflection equations in Figure 2, the deflection is always proportional to the load and length and inversely proportional to the modulus of elasticity and moment of inertia.

For example, when both ends are fixed with a uniformly distributed load, the deflection is determined by:

$$Y = \frac{FL^3}{384EI}$$

Therefore, to equate the stiffness using two different materials, the deflections are equated as follows:

$$\left[\frac{FL^3}{384EI} \right]_{\text{metal}} = Y = \left[\frac{FL^3}{384EI} \right]_{\text{plastic}}$$

Since the load and length are to remain the same, the FL^3 becomes a constant. Removing the constants from both sides of the equation yields:

Equation 1

$$[EI]_{\text{metal}} = [EI]_{\text{plastic}}$$

If the metal part were magnesium with a modulus of elasticity E of 45 GPa (6.5 Mpsi) and the thermoplastic chosen to replace it was AvaSpire® AV-621 CF30 with a modulus of elasticity of 17.2 GPa (2.49 Mpsi), then the moment of inertia must be increased to maintain equivalent deflection under load. The moment of inertia can be increased by increasing the thickness or adding ribs. Substituting the E values in equation 1:

$$(45 \times 10^9) I_{\text{metal}} = (17.2 \times 10^9) I_{\text{AvaSpire® PAEK}}$$

For equivalent deflection, I must be increased by a factor of 2.61.

The moment of inertia for a rectangular section is:

$$I = \frac{bd^3}{12}$$

where b is the width and d is the thickness of the section, substituting into our equation to determine the required thickness yields:

$$2.61 d_{\text{metal}}^3 = d_{\text{AvaSpire® PAEK}}^3$$

If d for the original metal part is 2.54 mm (0.10 inch), then the required thickness in AvaSpire® PAEK is given by:

$$d = \sqrt[3]{2.61(2.54)^3}$$

$$d = 3.45 \text{ mm (0.135 inch)}$$

To achieve equivalent deflection, the thickness has to be increased by approximately 36 %. However, ribs can be used to effectively increase the moment of inertia more efficiently as discussed in the next section.

Adding ribs to maintain stiffness

In the last section, it was determined that if a metal part were to be replaced with a part molded of AvaSpire® AV-621 CF30, a part thickness of 3.45 mm (0.135 inch) would be required to equal the stiffness of a 2.54 mm (0.10 inch) thick magnesium part.

By incorporating ribs into the AvaSpire® PAEK design, the wall thickness and weight can be reduced very efficiently and yet be as stiff as the magnesium part.

To demonstrate this, the moment of inertia (I) of the new rib design can be equated with that of the 3.45 mm (0.135 inch) thick plate design. Selecting the same material, AvaSpire® AV-621 CF30, the modulus of elasticity remains 17.2 GPa (2.49 Mpsi) in both cases; therefore, if the moment of inertia of the ribbed design is equal to the plate design, the parts will have equivalent deflection and/or stiffness.

From Figure 3, the I for a ribbed section is selected. By assuming that the section width “b” is the same for both, the I_{rib} has to be equal or greater than the I_{plate} .

Assigning a section width “b” = 25.4 mm (1.0 inch), the moment of inertia of a ribbed construction that will satisfy that condition can be calculated.

The moment of inertia for the plate design is:

$$I_{plate} = \frac{bh^3}{12} = \frac{25.4 \times (34)^3}{12} = 86.9 \text{ mm}^4$$

By choosing the arbitrary rib design shown in Figure 8.5, and working through the calculations, the moment of inertia is found to be:

$$I_{rib} = 1379 \text{ mm}^4$$

Figure 8.5 Rib design example

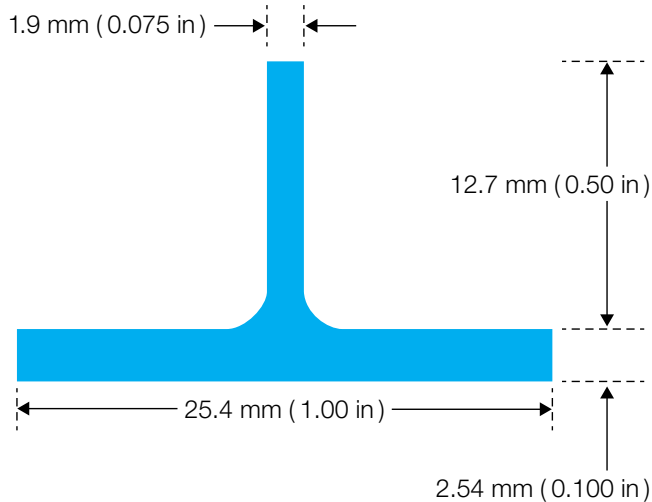

Placing one rib every 25.4 mm (1.0 inch) will increase the moment of inertia approximately 17 times. The designer can alter the rib height and rib width as well as the number and spacing of the ribs.

Designing for Sustained Load

Up to this point, the stress-strain calculations and examples have dealt with immediate stress-strain response and therefore short-term properties. If the part in question must sustain loads for long periods of time or at elevated temperatures, apparent (creep) modulus values must be used to account for the additional strain and part deflection that may occur.

Outside corners should have a radius equal to the sum of the radius of the inside corner and the wall thickness to maintain a uniform wall thickness.

Considering Stress Concentrations

Classical mechanical design may result in a component design which fails prematurely or at a much lower stress than predicted due to stress concentration. Stress concentrations may occur at sharp corners, around holes, or other part features. Impact and fatigue situations are especially sensitive to stress concentrations.

Minimizing sharp corners reduces stress concentrations and results in parts with greater structural strength.

To avoid stress concentration problems, inside corner radii should be equal to at least half of the nominal wall thickness. A fillet radius of 0.4 mm (0.015 inch) should be considered minimum.

Figure 8.6 shows the effect of inside corner radius on the stress concentration factor. For example, if the nominal wall thickness is 2 mm (0.080 inch) and an inside corner radius is 0.5 mm (0.020 inch), then the radius to thickness ratio is 0.25 and the stress concentration factor will be over two. A stress of x will have the effect of over 2x on the part.

Figure 8.6 Stress concentration at inside corners

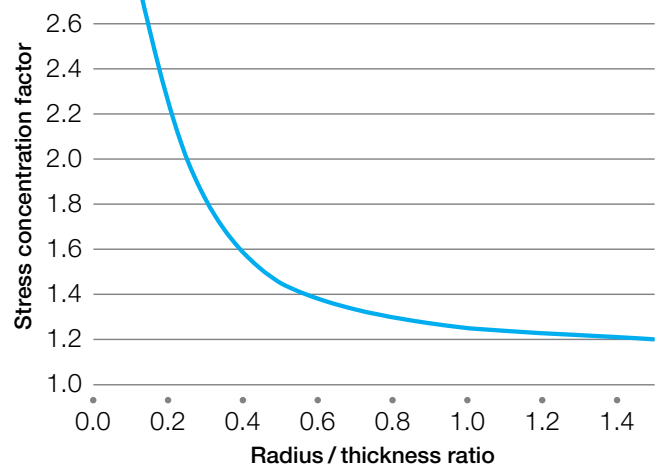

Outside corners should have a radius equal to the sum of the radius of the inside corner and the wall thickness to maintain a uniform wall thickness.

Computer Aided Engineering (CAE)

Designers can take advantage of the flexibility offered by injection molding to develop plastic parts with complex shapes and functions. Modern CAD tools allow designers to put flexibility into practice by building virtual models of the parts instead of building real prototypes. CAE tools add the capability to perform various types of numerical simulations on these virtual prototypes, such as injection molding simulations or mechanical stress analysis.

Using CAE to design a plastic part can provide more efficient use of the polymer, better moldability, and better performance of the final product. Cost savings can be achieved by reduced development time. More efficient design results in a lower cost part that costs less to produce.

The basic CAE package for the polymer industry includes injection molding and mechanical simulation by finite element analysis (FEA). For more complex cases, software exists that is capable of bridging the gap between the injection molding and the mechanical simulation for filled polymers by using predicted fiber orientations in the FEA. This allows simulation of the effect of different molding options (gate position, injection time, etc.) on the mechanical behavior of the final part, hence further improving the accuracy of the numerical models.

Injection Molding Simulation

The application of injection molding software for a plastic part has become a standard practice at a number of manufacturers and suppliers. Such software provides an understanding of mold filling, packing, and cooling before the tool is designed and built. Using the software, one can evaluate gate positions, weld line locations, air traps, and fiber orientation. It can also predict the injection pressure required to fill and pack the part along with many other critical issues that impact part moldability and part quality.

Some of the most common results of a flow analysis are the flow of the plastic vs. time (fill pattern), the pressure required to fill the part (pressure profile), weld line locations, and fiber orientation. Often, a warpage analysis that incorporates the effects of crystallinity, cooling, and fiber orientation is also performed. This type of analysis takes into account many important aspects of the molding process, such as temperatures, packing efficiency, shrinkage data, and fiber orientations, and ultimately allows an estimation of the final dimensions and shape of a molded part.

It is critical to recognize that the simulation of the injection molding process includes complex equations involving thermodynamics, fluid dynamics, and heat transfer. The analysis is based on a number of assumptions and simplifications. Correlating simulation results with experimental evidence is recommended to gain a better insight of the accuracy that can be expected from such simulation and achieve higher confidence.

Finite Element Analysis (FEA)

Mechanical simulations using FEA estimate the stresses and strains of a part under a given set of service conditions. There are many limitations regarding the use of textbook formulae to calculate the mechanical response of a complex part.

The FEA involves building a numerical model of a particular mechanical testing situation. This process requires the knowledge and availability of different data:

- CAD model of the studied component(s)
- Material properties: The mechanical behavior model of the chosen polymer material, taking into account the temperature, moisture content and time-scale of loading (quasi-static, long term or dynamic); thermal expansion information is also often needed if elevated service temperatures are to be considered.
- Boundary conditions of the test case to be simulated, which covers fixation points, contact area, etc.
- Loads, such as forces, moments or temperature fields

The material properties of the plastic part are extremely dependent on the molding process. For filled polymers, fiber orientation during the flow leads to anisotropic mechanical properties in the molded component. However, the classical approach for the mechanical analysis of such parts is based on the assumption that the material properties are isotropic in the part (identical everywhere and in all directions). The tensile data typically available for this simulation is generated using standardized molded tensile bars. Indeed, these molded tensile bars exhibit very good fiber orientation, hence leading to favorable mechanical properties along the test direction.

The use of this tensile data as such to define isotropic behavior of a real molded component typically leads to an over-estimation of the mechanical response; therefore, it is common to weight the published tensile stress-strain curves obtained from testing by a factor close to 0.7 for isotropic numerical simulations. For filled polymers, the isotropic assumption and the choice of the weighting factor is arbitrary and very much dependent on the type of part, the injection process parameters and material formulations.

Another important aspect linked to the material behavior is the choice of the material model: Is a linear elastic assumption valid or is a nonlinear material model needed? This is very much dependent on the polymer and the test conditions. For instance, a highly filled polymer used at low temperatures and low strains usually exhibits a linear stress-strain response. In that case, performing linear elastic FEA is sufficient and allows quick evaluations of different design options. However, for unfilled grades or materials in high temperature or moisture conditions, one can easily observe that the stress-strain curves become more and more nonlinear. This usually means that

the linear elastic assumption is still valid but only within a reduced range of low strains and low stresses. In that case, it is advisable to use nonlinear FEA packages that permit more accurate modeling of the material, capturing the nonlinearity (for instance elasto-plasticity). This covers the commonly used short-term, quasi-static simulations.

More complex simulations can also involve creep (long-term deformation) or strain-rate dependent response to rapid loading such as impact or drop testing. Nonlinear simulation packages generally offer material models that allow more accurate representations of polymer behavior in a molded part.

Coupling the Injection Molding and Mechanical Simulations

New sophisticated micromechanical simulation software based on homogenization rules offers an interesting alternative to the isotropic mechanical assumption. These tools allow the fiber orientation data to be imported to the FEA package from the injection molding simulation. This software allows the definition of an anisotropic nonlinear behavior model using this fiber orientation data. To access this technology, one needs to perform appropriate and specific material characterization based on real testing for different sets of orientation and reverse engineering techniques. Please contact your Solvay representative to access data and simulation assistance.

Designing for Assembly

Interference or Press Fits

One of the most economical methods that can be used to assemble two parts is a press fit. The joint is achieved by pressing or forcing the shaft into a hole whose diameter is smaller than the diameter of the shaft. The difference in diameter between the hole and shaft is referred to as the diametrical interference. The force maintaining the joint is primarily a compressive stress on the shaft resulting from the hoop stress in the hub created by the insertion of the shaft. Depending upon the relative moduli of the shaft and hub materials, the compressive stress in the shaft can also contribute to maintaining the joint. The stress holding an interference fit will exhibit relaxation over time in a manner that is analogous to creep because the apparent modulus of the polymeric material decreases over time.

Calculating the Allowable Interference

The allowable interference between a shaft and a hub can be determined by using the general equation:

$$I = \frac{S_d D_s}{F} \left[\frac{F + \nu_h}{E_h} + \frac{1 - \nu_s}{E_s} \right]$$

And the geometry factor, F, is given by:

$$F = \frac{1 + \left(\frac{D_s}{D_h}\right)^2}{1 - \left(\frac{D_s}{D_h}\right)^2}$$

Where:

I = Diametrical interference

S_d = Working stress

D_h = Outside diameter of the hub

D_s = Diameter of the shaft

E_h = Modulus of the hub material

E_s = Modulus of the shaft material

ν_h = Poisson's ratio of the hub material

ν_s = Poisson's ratio of the shaft material

F = Geometry factor

If the shaft and hub are made from the same resin grade, then:

$$E_h = E_s = E$$

and the interference is:

$$I = \frac{S_d}{E} D_s \left(\frac{F + 1}{F} \right)$$

If the hub is made of AvaSpire® PAEK and the shaft is made of metal, then the interference is:

$$I = \frac{S_d D_s}{F} \frac{F + \nu_h}{E_h}$$

When a press fit is used with dissimilar materials, the differences in thermal expansion can increase or decrease the interference between two mating parts. This could increase or reduce the stress affecting joint strength.

A press fit can creep or stress relax over time. This could cause a decrease in the retention force of the assembly. Therefore, testing the assembly under its expected operating conditions is highly recommended.

Mechanical Fasteners

Mechanical fasteners provide an economical method of joining dissimilar materials together. Fasteners frequently used with injection molded plastic parts include screws, bolts, nuts, lock washers and lock nuts. When using metal mechanical fasteners, good design practice should be used to prevent the plastic parts being assembled from becoming overstressed.

The most obvious procedure for preventing a highly stressed assembly is to control the tightening of the mechanical fasteners with torque limiting drivers. When torque cannot be controlled, as might be the case with field assembly, shoulder screws will limit compression on the plastic part. Other alternatives may be to use flange-head screws, large washers or shoulder washers. Figure 8.7 presents some preferred designs when using mechanical fasteners.

Figure 8.7 Designing for mechanical fasteners

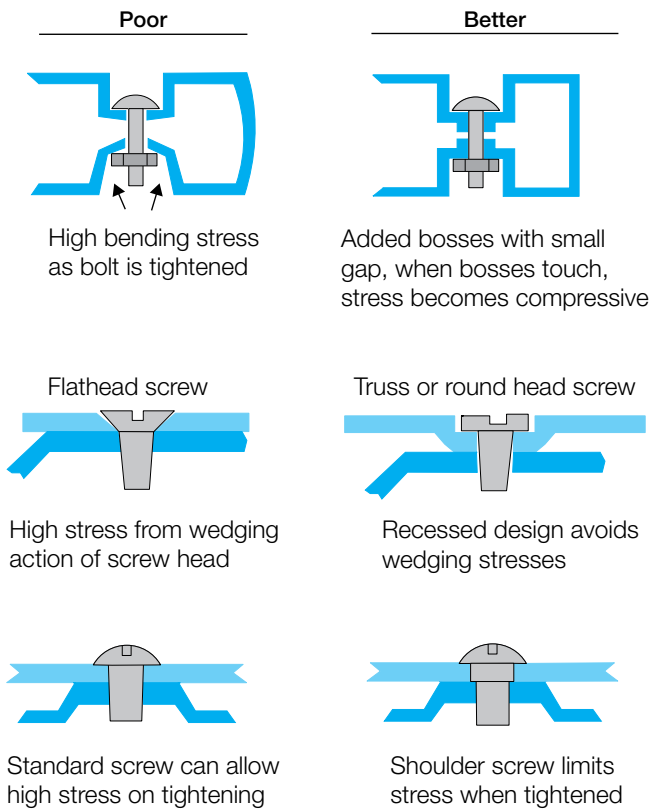

Self-tapping screws

A common type of mechanical fastener used with plastics is a self-tapping screw. A self-tapping screw cuts or forms threads as it is inserted into the plastic and eliminates the need for molding internal threads or the secondary operation of tapping the thread form by machining. The major types are thread-forming and thread-cutting.

The modulus of elasticity of the plastic material plays an important role in deciding what type of self-tapping screw is most suitable for the application. For plastic materials with a modulus less than 3.0 GPa (440 kpsi), such as most unreinforced resins, thread-forming screws are best since the plastic is ductile enough to be deformed without cracking or shearing. For glass and mineral filled grades, thread-cutting screws are preferred.

For optimum strip-out torque, the hole diameter of the boss should be equal to the pitch diameter of the screw. The outer diameter of the boss should be equal to two or three times the hole diameter and the boss height should be more than twice the thickness of the boss.

Figure 8.8 illustrates the basic boss design for use with self-tapping screws.

Figure 8.8 Boss design for self-tapping screws

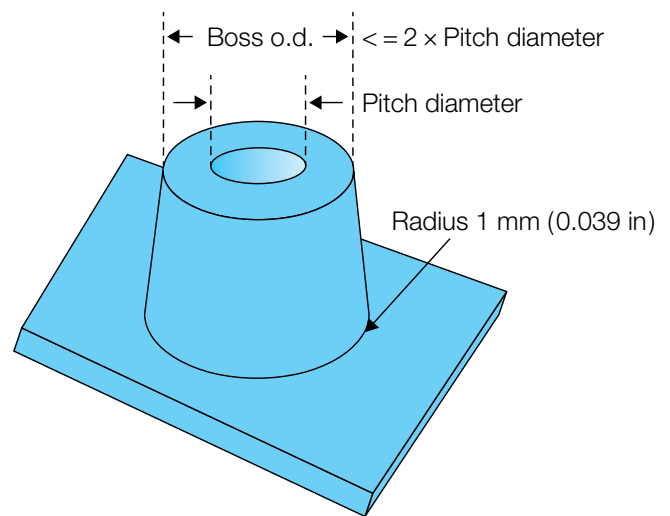

To avoid stripping or high stress assemblies, torque controlled drivers should be used on assembly lines.

Improving torque retention

To minimize the loss of torque due to creep, reduce the compressive stress under the screw head by:

- Increasing the screw head diameter
- Using a large-diameter flat washer
- Reducing the clamping torque
- Using a spring or spiral washer
- Using shoulder bolt to reduce stresses on plastic part
- Using a metal bushing

Tightening torque

Figure 8.9 shows how torque changes as a function of screw penetration. Tightening torque is the recommended installation torque for a given application. It must be high enough to fully engage the screw threads and develop clamp load but lower than the torque that would cause failure of the threads, known as the stripping torque.

Figure 8.9 Torque developed during screw installation

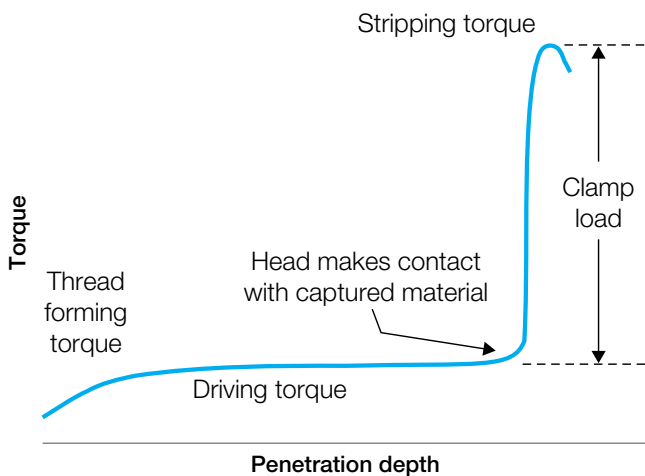

The optimum tightening torque value can be calculated from the average driving torque and the average stripping torque using the following equation.

$$T_T = \frac{1}{2} \left(\frac{3}{2} T_D + \frac{1}{2} T_s \right)$$

Where:

- T_T = Tightening torque
- T_D = Average driving torque
- T_s = Average stripping torque

Some self-tapping screws have been designed specifically for use with plastics and these have the advantage of having a greater difference between driving and stripping torque than the typical screws designed for metal. These special fasteners can provide an additional safety factor for automated assembly.

Pull-out force calculation

The strength of a joint can be characterized by the amount of force required to pull-out a screw. The pull out force can be estimated by using the following equation:

$$F = \pi S D L$$

Where:

- F = Pull out force
- S = Shear strength
- D = Pitch diameter
- L = Thread engagement length

When repeated assembly and disassembly are required or expected, threaded metal inserts should be used instead of self-tapping screws.

Threaded inserts

Threaded metal inserts can be used to provide permanent metal threads in a plastic part; a wide variety of sizes and types are available. Inserts are usually installed in molded bosses whose internal diameter is designed for the insert. The most commonly used metal inserts are either molded-in or ultrasonically placed in the part as a secondary operation. In the case of the molded-in insert, the insert is placed in the mold and the plastic is injected around it. Stress will develop when the plastic cools around the insert. To reduce this stress, heat the inserts to the temperature of the mold.

The ultrasonic insert is pressed into the plastic by melting the plastic with high frequency vibrations, generated by an ultrasonic welding machine. The ultrasonic welding melts material around the metal insert as it is being installed, forming a bond between the insert and the plastic that is usually strong and relatively free of stress.

Figure 8.10 depicts the recommended insert and boss designs for use with AvaSpire® PAEK resin.

Figure 8.10 Boss design for ultrasonic inserts

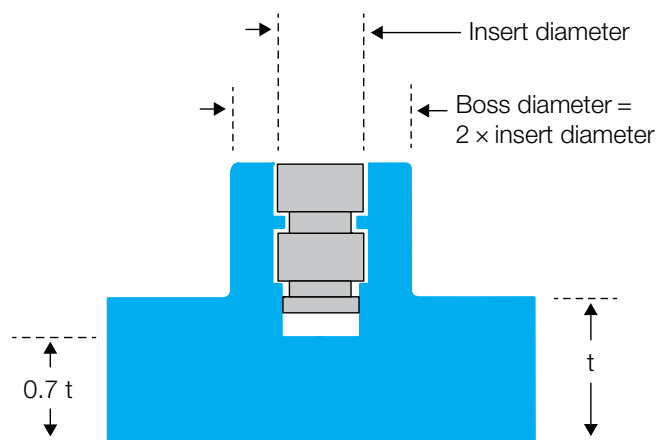

Molded-in threads

One of the benefits of using plastic materials instead of metals is the ability to mold thread forms directly into the part. This eliminates the secondary machining operations needed with metal parts to form the threads. molded-in threads can be either external or internal. In the case of internal threads, some type of unscrewing or collapsible core is required. External threads can be formed more easily if the parting line of the mold is perpendicular to the thread.

Designing with Snap Fits

The use of snap fits in plastics is very prevalent. All snap fit designs require the plastic to flex like a cantilever spring as it moves past an interference that is designed on the mating part. Once the flexible arm moves past the interference, it returns to its normal unflexed, unstressed position. Usually a step or protrusion has been designed on the cantilever that engages and locks into the mating part, creating a simple assembly method without additional parts. This is shown in Figure 8.11.

Each cantilever arm must deflect a distance “Y” in order to be inserted. The key to proper snap design is to not exceed the strain/stress limits of the material being used. A snap fit design that has been used for a ductile, low modulus plastic will probably not be suitable for a highly reinforced, very rigid plastic.

For rigid materials, the length of the cantilever may be increased or the interference deflection “Y” reduced. Adding a “stop” can prevent over deflection of the cantilever during assembly.

Figure 8.11 Cantilever type snap fit

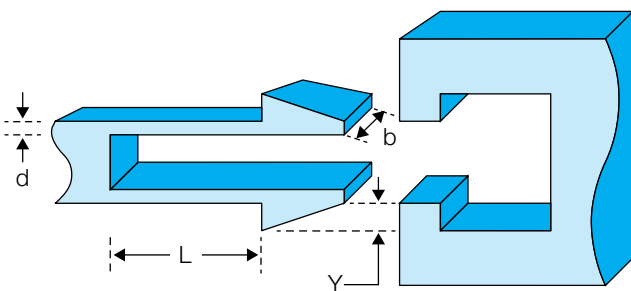
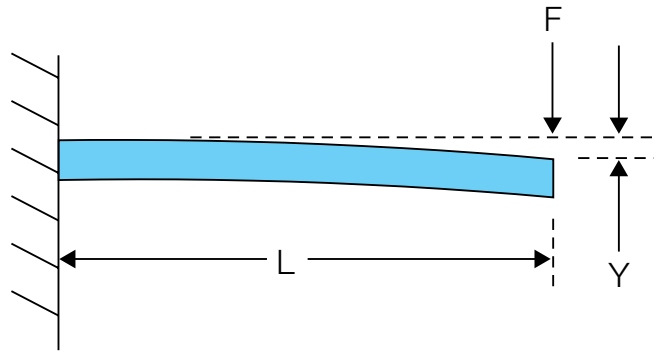

Figure 8.12 Cantilever beam with concentrated load at free end



Since this beam has a rectangular cross section,

$$Z = \frac{bd^2}{6} \text{ and}$$

$$I = \frac{bd^3}{12}$$

Therefore:

$$\sigma = \frac{FLd}{2I}$$

The deflection of the beam, Y, is given by:

$$Y = \frac{FL^3}{3EI}$$

Solving the deflection equation for F, the force needed to deflect the beam can be calculated as follows:

Equation 1

$$F = \frac{3YEI}{L^3}$$

The modulus of elasticity, E, is defined as:

$$E = \frac{\sigma}{\epsilon} \text{ and therefore } \epsilon = \frac{\sigma}{E}$$

substituting that in the cantilever stress equation:

Equation 2

$$\epsilon = \frac{FLd}{2EI}$$

Using the relationship of equation 1 and substituting for F in equation 2 the relationship between strain and deflection is derived:

Table 8.4 Strain recommendations for cantilever snap fits

AvaSpire® Grade	One-Time Assembly Max. Design Strain [%]	Multiple Assembly Max. Design Strain [%]
AV-621 NT	6.0	3.0
AV-651 NT	6.0	3.0
AV-722 NT	5.0	2.5
AV-848 NT	6.0	3.5
AV-621 GF30	2.0	1.5
AV-651 GF30	2.0	1.5
AV-848 GF30	1.5	1.2
AV-621 CF30	1.5	1.2
AV-651 CF30	1.0	0.8
AV-722 CF30	1.0	0.8
AV-848 CF30	1.0	0.8

Equation 3

$$\epsilon = \frac{3Yd}{2L^2}$$

This equation allows the designer to calculate the strain required from the maximum deflection of a design. Table 8.4 summarizes maximum strain recommendations for several grades of AvaSpire® PAEK resins.

Once a suitable grade of AvaSpire® PAEK has been selected, the basic equations can be used to find the load, F , needed to deflect the cantilever the required amount.

In a cantilever snap fit, the stress and strain are maximum at the base of the cantilever and become proportionately lower toward the tip where the load is applied. In fact the stress and strain at any point can be calculated by substituting a different L , the distance from the load toward the fixed end. Therefore, if the cantilever thickness was gradually reduced from fixed end to tip, the beam will be able to deflect more than in the fixed thickness cantilever without incurring higher maximum stresses. In this way, the capability of the material can be maximized.

Tapered Cantilever Beam Equation

For the tapered design shown in Figure 8.13, h_L is the thickness at the free end. The value of the proportionality constant, K , for a tapered beam design can be found in Figure 8.14. The maximum strain can be calculated from:

Equation 4

$$\epsilon = \frac{3Yh_0}{2L^2K}$$

For example, if the beam thickness has been gradually reduced to half its fixed end thickness; the ratio of h_L to h_0 would be 0.5 and K (from Figure 8.14) would be 1.6. Therefore, the maximum strain and the corresponding stress would be multiplied the reciprocal of K , 0.625. The strain will be reduced by about 40 % of the strain of a constant thickness cantilever beam design with equal deflection.

Figure 8.13 Snap fit design using tapered beam

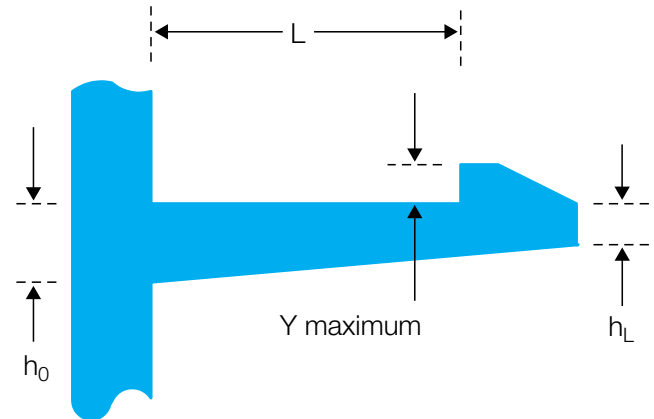
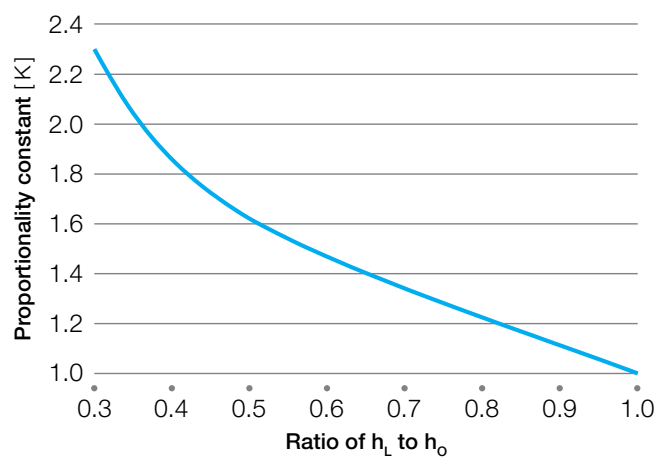

Figure 8.14 Proportionality constant (K) for tapered beam



Designing for Injection Molding

Many of the applications for AvaSpire® PAEK resins will be manufactured using the injection molding process. An engineer who has designed a part to meet the performance requirements of the application must also take into account the fact that there are elements in the part design that can influence moldability. These factors include wall thickness and wall thickness transitions, draft, ribs, bosses, and coring. The effect of these factors on moldability should be considered by the design engineer before a mold is built to make the part.

Wall Thickness

In general, parts should be designed with the thinnest wall that will have sufficient structural strength to support the expected loads, keep deflection within design criteria limits, have adequate flow, and meet flammability and impact requirements. Parts designed in this manner will have the lowest possible weight, and therefore the lowest material cost, and the shortest molding cycle.

Wall Thickness Variation

Part designs that contain uniform wall thicknesses are ideally suited for the injection molding process. They minimize molded-in stress, reduce the potential for sink marks on the surface of the part, and eliminate the potential for voids in a molded part. However, structural, appearance, and draft considerations may require varying wall thicknesses. When changes in wall section thickness are necessary, the designer should consider a gradual transition, such as the tapered or gradual designs shown in Figure 8.15.

Sharp transitions may create problems in appearance and dimensional stability, because they may result in differential cooling and turbulent flow. A sharp transition may also result in a stress concentration, which may adversely affect part performance under loading or impact.

Draft Angle

To aid in the release of the part from the mold, parts are usually designed with a taper. The taper creates a clearance as soon as the mold begins to move, allowing the part to break free from its mold cavity. The taper is commonly referred to as draft, and the amount of taper as draft angle, as shown in Figure 8.16.

Adequate draft angle should be provided to allow easy part removal from the mold. Generally, the designer should allow a draft angle of 0.5° to 1° per side for both inside and outside walls for AvaSpire® PAEK. However, in some special cases, smaller draft angles, as low as 1/8° to 1/4°, have been used with draw polish on the mold surface.

More draft should be used for deep draws or when cores are used. Textured finishes increase draft requirements by a minimum of 1° per side for each 0.025 mm (0.001 in.) of texture depth.

Ribs

The stiffness of a part design can be increased with properly designed and located ribs, without creating thick walls. Proper rib design will allow for decreased wall thickness. This will save material and weight, and shorten molding cycles. It will also eliminate thick walls, which can cause molding problems like sink marks on the surface of parts or voids on the inside of parts. Ribs that are correctly positioned may also function as internal runners, assisting plastic melt flow during molding.

Figure 8.15 Wall thickness transition

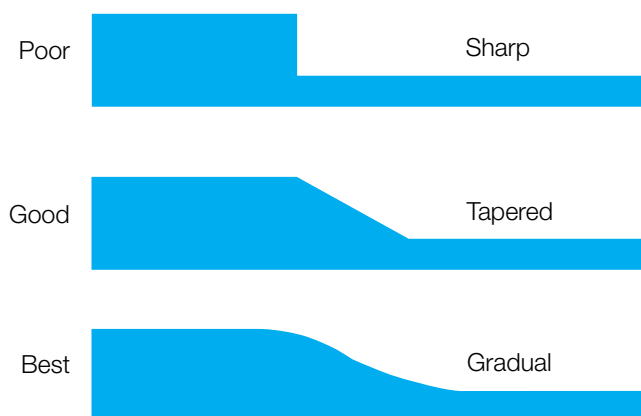

Figure 8.16 Draft – designing for mold release

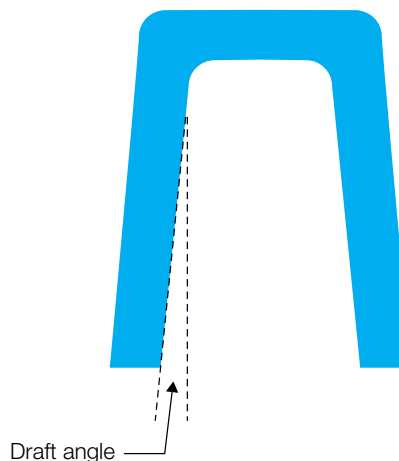
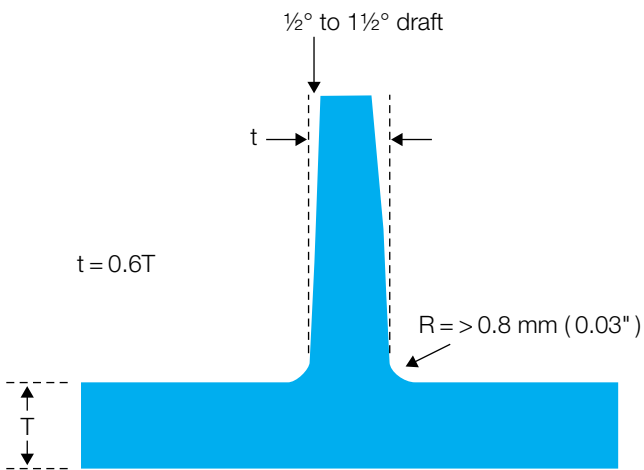

Figure 8.17 Draft – recommended rib design



In general, the following guidelines should be used when designing with ribs. The thickness at the rib base should be no greater than 60 % of the adjacent wall thickness. When ribs are opposite appearance areas, the width should be kept as thin as possible. If there are areas in the molded part where structure is more important than appearance, then ribs are often 75 %, or even 100 %, of the outside wall thickness. Whenever possible, ribs should be smoothly connected to other structural features such as side walls, bosses, and mounting pads. If there are several ribs in a part, they need not be constant in height or width, and are often matched to the stress distribution in the part. All ribs should have a minimum of $\frac{1}{2}^\circ$ of draft per side and should have a minimum radius of 0.8 mm (0.03 in.) at the base to reduce stress concentrations and sink marks.

Figure 8.17 shows the recommended rib size relationships.

Coring

Proper design practice should include uniform wall thickness throughout a part. Heavy sections in a part can extend cycle time, cause sink marks on the part surface, cause voids within the part and increase molded-in stresses.

Heavy sections should be cored to provide uniform wall thickness. For simplicity and economy in injection molds, cores should be parallel to the line of draw of the mold. Cores placed in any other direction usually create the need for some type of side action or manually loaded and removed loose cores.

Cores which extend into the cavity will be subject to high pressure. For blind cores (cores that are unsupported) that have diameters greater than 1.5 mm (0.060 in.) the core lengths should not exceed three times the diameter, while blind cores with diameters less than 1.5 mm (0.060 in.) should not exceed twice their diameter in length. These recommendations may be doubled for through cores (cores that telescope into or shut off with the opposite side of the mold). Draft should be added to all cores, and all tooling draw polished for best ejection.

Bosses

Bosses are projections from the nominal wall of a part that will eventually be used as mounting or fastening points. The design of bosses is largely dependent upon their role in a given part. Cored bosses can be used for press fits, self-tapping screws, and ultrasonic inserts. Each of these will exert stress on the wall of the boss.

As a general guideline, the outside diameter of a boss should be twice the inside diameter of the hole, and the wall thickness at the base of the boss should not exceed 60 % of the part wall thickness unless structural concerns override appearance requirements. Figure 8.18 illustrates these guidelines.

Additional forces imposed on bosses may tend to be transmitted down the boss and into the nominal wall. For this reason, a minimum radius of 25 % of the wall thickness is required at the base of the boss to provide strength and reduce stress concentration. A boss can be further strengthened by using gusset-plate supports around the boss, or attaching it to a nearby wall with a properly designed rib. Bosses should be designed in the same manner as ribs. Heavy sections should be avoided to prevent the occurrence of sink marks on the surface and voids in the interior of the part.

Figure 8.18 Boss design – general guidelines

O.D. = 2 × I.D.

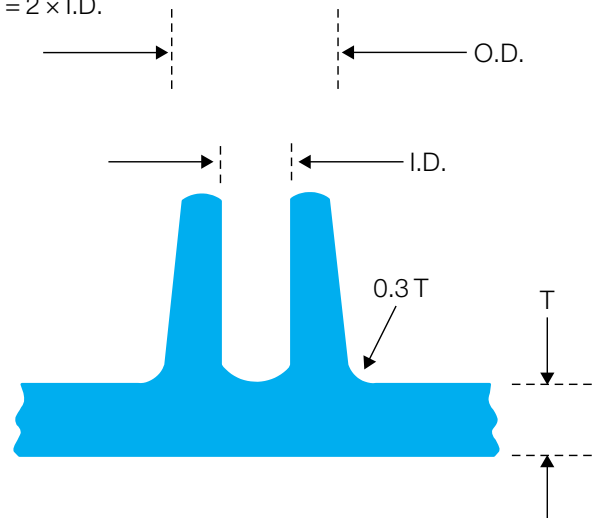

Processing

Rheological Properties

The fabrication of thermoplastic materials, such as AvaSpire® polyaryletherketone (PAEK), often involves melting the material and subjecting it to a force that causes the material to flow into a mold or die where it is cooled. To provide basic rheological data to fabricators and designers, the viscosity of various

grades of AvaSpire® PAEK were measured at a variety of temperatures and shear rates. The data were collected using an LCR capillary rheometer according to ASTM test method D3835 using a 300-second melt time.

The results are shown in Table 9.1 and Figures 9.1 through 9.13.

Table 9.1 Viscosity vs. shear rate of AvaSpire® PAEK

Grade	Shear Rate [sec ⁻¹]	Apparent Viscosity [Pa · s (Poise = Pa · s × 10)]		
		370 °C (698 °F)	385 °C (725 °F)	400 °C (752 °F)
AV-621 NT	100	1,291	1,047	916
	1,000	524	464	402
	10,000	157	135	128
AV-651 BG15	100	514	434	318
	1,000	310	259	214
	10,000	111	99	92
AV-621 GF30	100	2,510	2,096	1,786
	1,000	916	763	661
	10,000	509	274	200
AV-651 GF30	100	1,204	993	850
	1,000	530	448	403
	10,000	166	142	141
AV-722 BG20	100	1,559	1,537	
	1,000	577	587	
	10,000	196	172	
AV-750 GF40	100	999	975	
	1,000	381	371	
	10,000	150	128	
AV-722 CF30	100	3,092	2,983	
	1,000	951	842	
	10,000	502	294	

Apparent Viscosity [Pa · s (Poise = Pa · s × 10)]

Grade	Shear Rate [sec ⁻¹]	370 °C (698 °F)	385 °C (725 °F)	400 °C (752 °F)
AV-722 SL30	100	2,729	2,418	
	1,000	547	475	
	10,000	212	141	
AV-742 SL30	100	1,550	1,134	
	1,000	432	281	
	10,000	89	75	
AV-755 SL45	100	4,096	3,795	
	1,000	967	909	
	10,000	228	188	
AV-848 BK95	100	1,847	1,450	1,161
	1,000	672	588	483
	10,000	292	190	150
AV-848 GF30	100	1,786	1,220	1,030
	1,000	577	483	408
	10,000	219	173	147
AV-848 CF30	100	1,877	1,581	1,198
	1,000	740	602	515
	10,000	225	158	141

Figure 9.1 AvaSpire® AV-621 NT

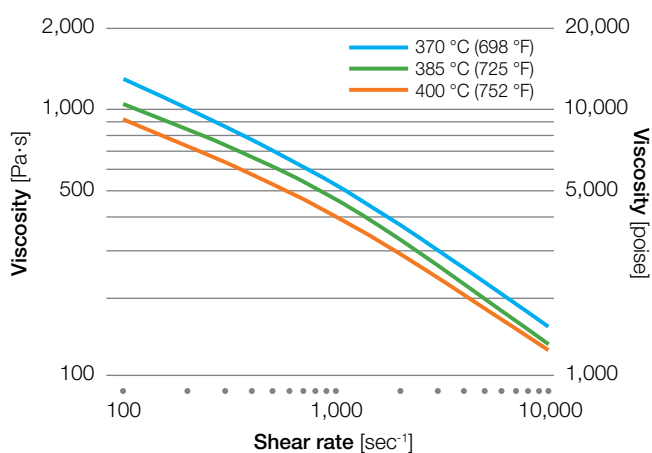

Figure 9.3 AvaSpire® AV-621 GF30

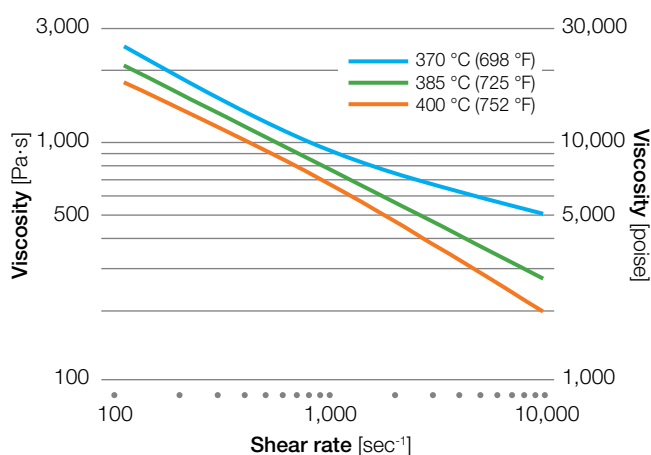

Figure 9.2 AvaSpire® AV-651 BG15

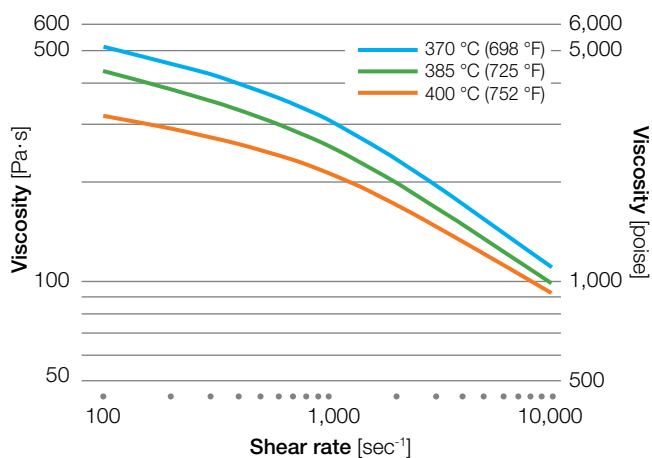

Figure 9.4 AvaSpire® AV-651 GF30

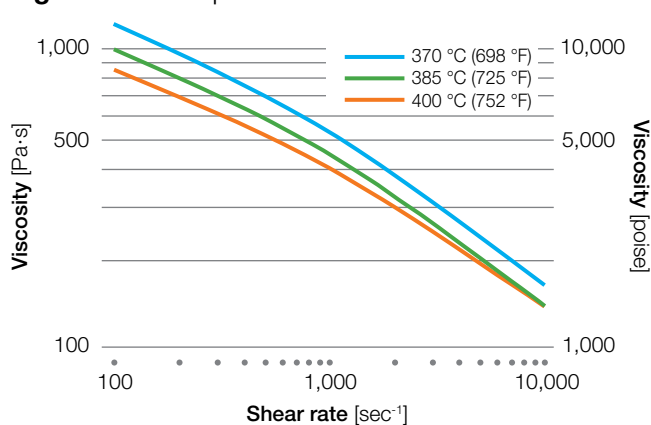

Figure 9.5 AvaSpire® AV-722 BG20

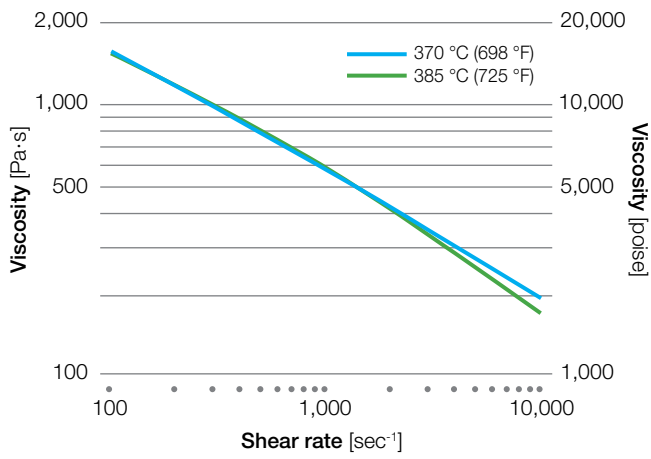

Figure 9.8 AvaSpire® AV-722 SL30

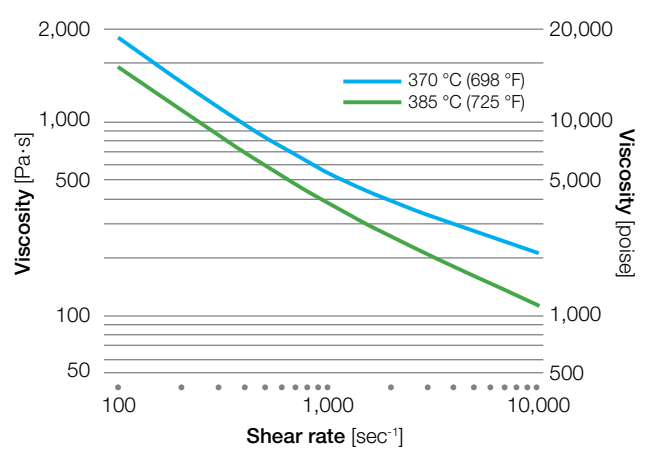

Figure 9.6 AvaSpire® AV-750 GF40

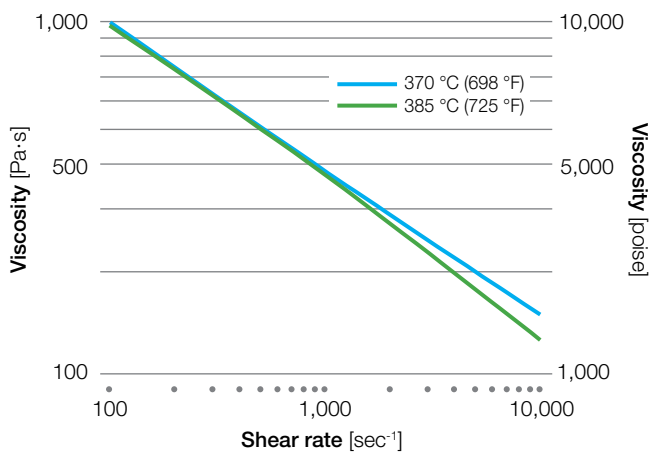

Figure 9.9 AvaSpire® AV-742 SL30

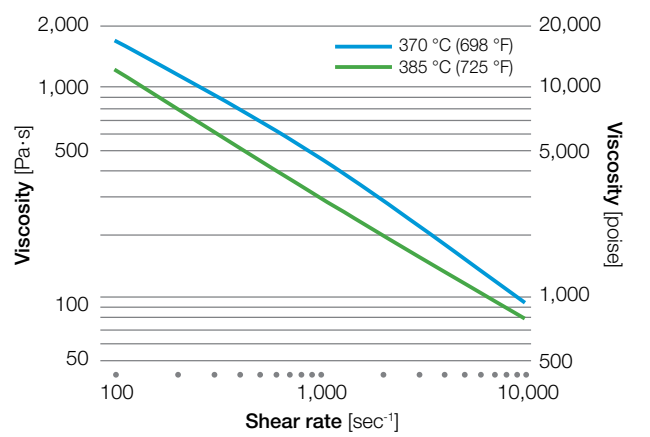

Figure 9.7 AvaSpire® AV-722 CF30

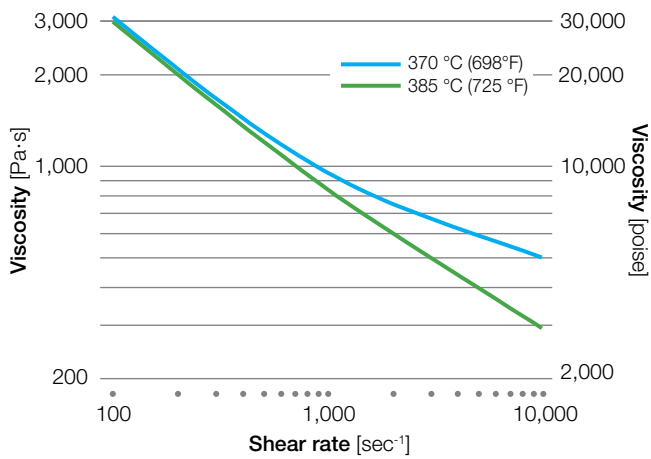

Figure 9.10 AvaSpire® AV-755 SL45

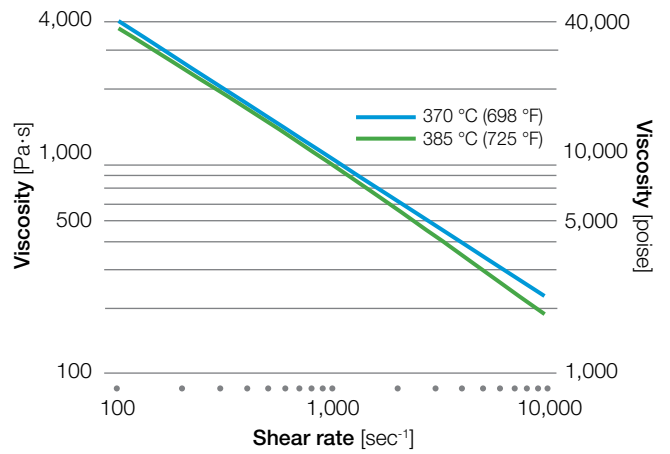

Figure 9.11 AvaSpire® AV-848 BK95

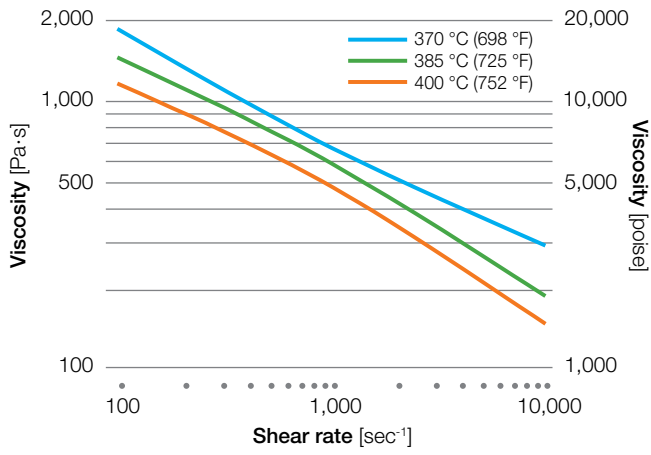

Figure 9.13 AvaSpire® AV-848 CF30

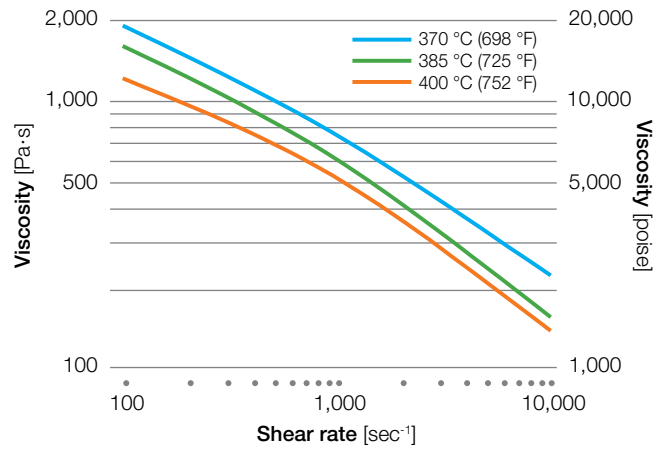
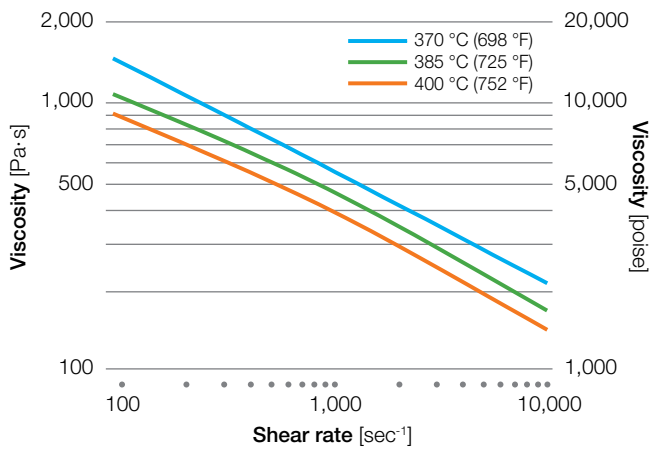

Figure 9.12 AvaSpire® AV-848 GF30



Injection Molding

One of the primary processes for the fabrication of articles from thermoplastic resins is injection molding. Plastic pellets are melted in a barrel containing a rotating screw which retracts as the plastic melts. The screw is then driven forward injecting the molten plastic into a mold. The plastic solidifies, taking the shape of the cavity, and then the mold is opened by retracting the movable platen and the article is ejected from the mold. While simple in principle, there are many parameters that must be carefully controlled to consistently produce high-quality articles. This document provides guidance for the successful injection molding of AvaSpire® polyaryletherketone (PAEK).

Equipment for Injection Molding

Injection molding machine

AvaSpire® PAEK resins can be readily processed on conventional injection molding equipment. The equipment should be capable of achieving and maintaining the required processing temperatures of up to 385 °C (725 °F) on the injection unit and up to 205 °C (400 °F) on the mold. The molding machine should be equipped with a linear transducer to monitor screw position and should be capable of controlling the polymer injection by a velocity/position profile. The molding machine should have the capability to generate injection pressures of up to 240 bar (35 kpsi) to allow for fast injection.

Clamping pressure

Due to the relatively high pressures necessary to process AvaSpire® PAEK resins, the molding machine should have a minimum clamping pressure of 30 t/cm² (5 ton/inch²). To determine the minimum clamping pressure recommended, calculate the projected cavity area at the parting line, including the runner system, and multiply by the recommended value. Insufficient clamp force may result in parting line flash.

Screw design

For molding AvaSpire® AV-700 series resins, a general purpose type screw should be used. It should have an L/D of 18 to 25:1 and a compression ratio of 2.5 to 3.5:1 with a sliding check ring to prevent the polymer from flowing back over the flights during injection. The flights should be equally divided between the feed, transition, and metering zones and the minimum flight depth at the feed end of the screw should be 6 mm (0.236 inch). Ball check valves are not recommended nor are high-intensity mixing elements. The screw for molding AvaSpire® AV-600 series resins will be similar except for the compression ratio which should be 2.0 to 3.0:1.

The screw should be constructed of an alloy suitable for high-temperature operation, such as CPM9V, and hardened to 50-55 Rockwell C. AvaSpire® PAEK resins are not corrosive to steel; therefore, special alloys, coatings, or platings are not required.

Nozzle

A general purpose nozzle tip with a reverse taper is recommended. Nozzle orifice diameter should be slightly smaller than the diameter of the sprue bushing, but not less than 3 mm ($\frac{1}{8}$ inch). Nozzle shut off devices are not recommended. An insulated nozzle tip can prevent heat loss to the sprue bushing and eliminate nozzle freezing problems. This is especially useful with the thermally conductive (carbon-fiber reinforced) grades.

Figure 9.16 Nozzle with reverse taper

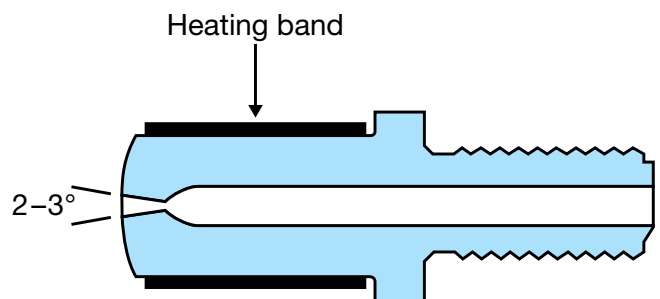
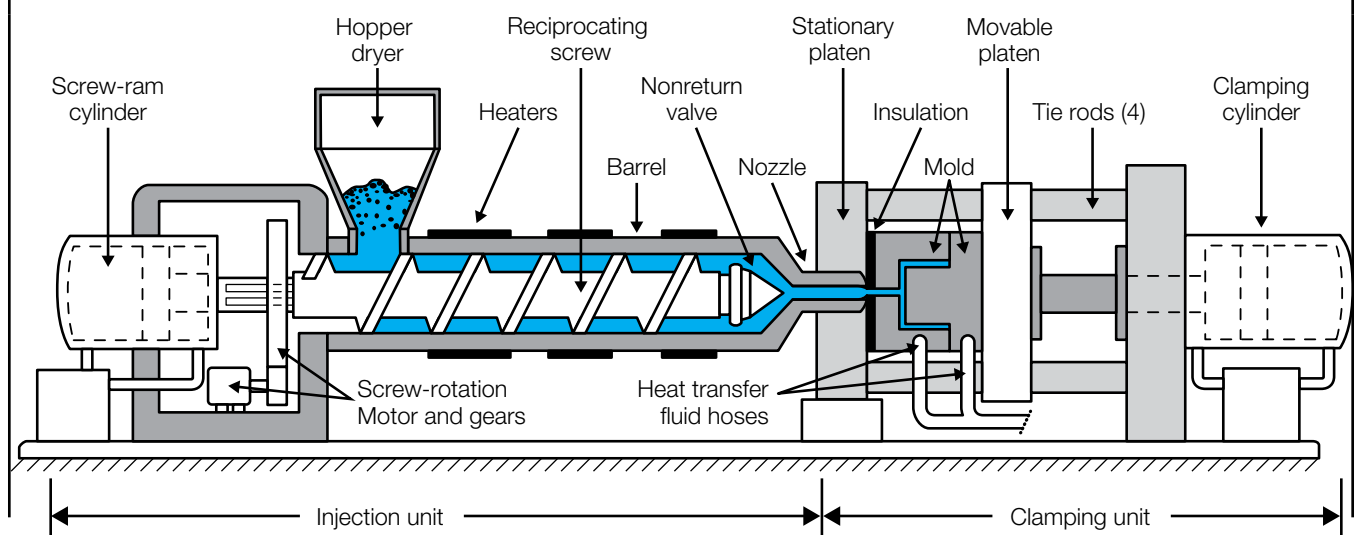

Figure 9.15 Injection molding machine schematic



Tooling

Tool steel

Due to the high processing temperatures of AvaSpire® PAEK resins, appropriate tool steels such as S-7 or H-13 (or equivalent) tool steel are recommended. Tools should be hardened to a minimum Rockwell C Hardness of 50. AvaSpire® PAEK resins are not corrosive, therefore, special coatings or plating are not required.

Tool types

Two plate tools are most common. The cavity should be positioned so that the majority of the part is formed in the movable half to ensure that the molded part stays in the movable half of the tool upon mold opening. Edge, diaphragm, or tunnel gates may be used with two plate tools.

Figure 9.17 Two plate tool

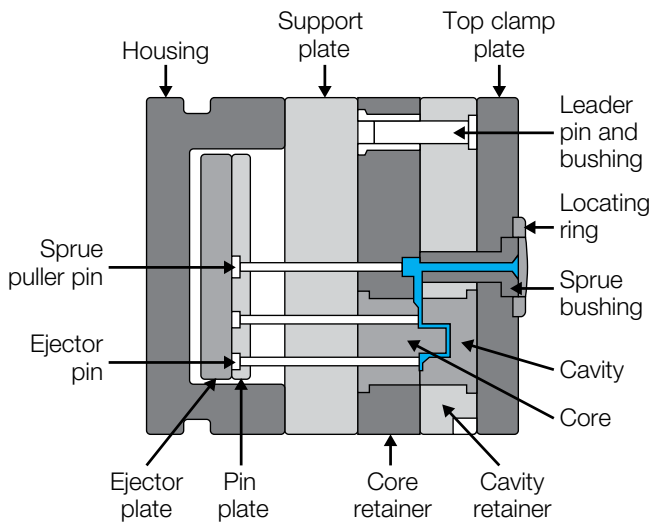

Three plate tools are somewhat more complex; however, they offer several benefits including self degating and the ability to place multiple gates in a single cavity to facilitate filling large, thin parts.

Figure 9.18 Three plate tool

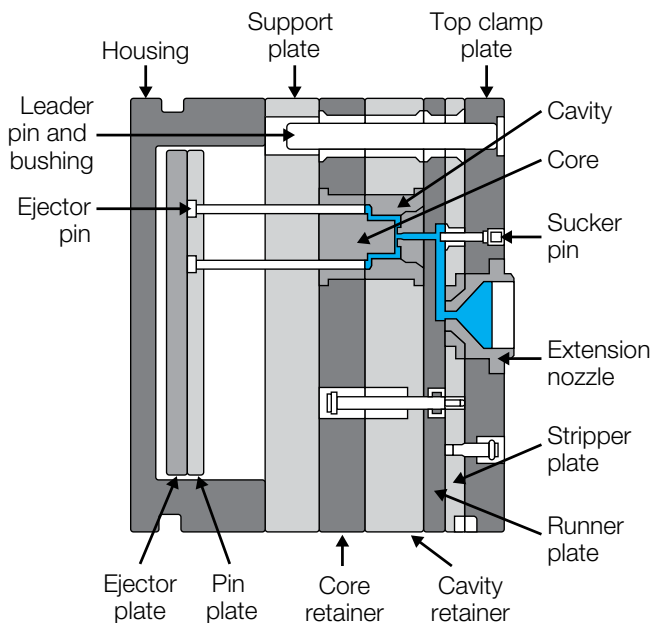

With three plate tools, the runner is formed between the stationary and center plates and the cavities are placed between the center and movable plates. Upon mold opening, the runner is separated from the cavities and can be handled separately. The stationary plates usually contain “sucker” pins (undercuts in the runner system) to keep the runner on the stationary plate on ejection and then an ejector plate demolds the runner after mold opening.

The center plate should be as thin as possible to minimize runner mass; however, it should be thick enough to allow heating/cooling lines for thermal management.

Cavity Layout

Multi-cavity tools should be balanced so that all cavities fill at the same rate. All cavities should be equally spaced in the tool so that the distance from the sprue to each cavity is the same.

Figure 9.19 Unbalanced

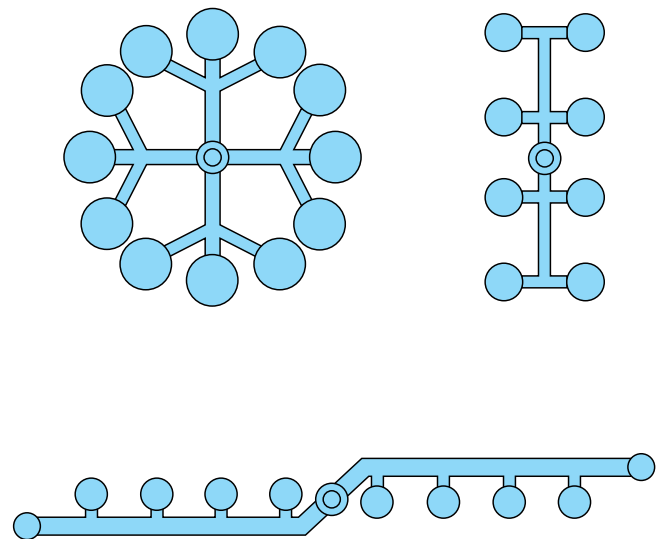
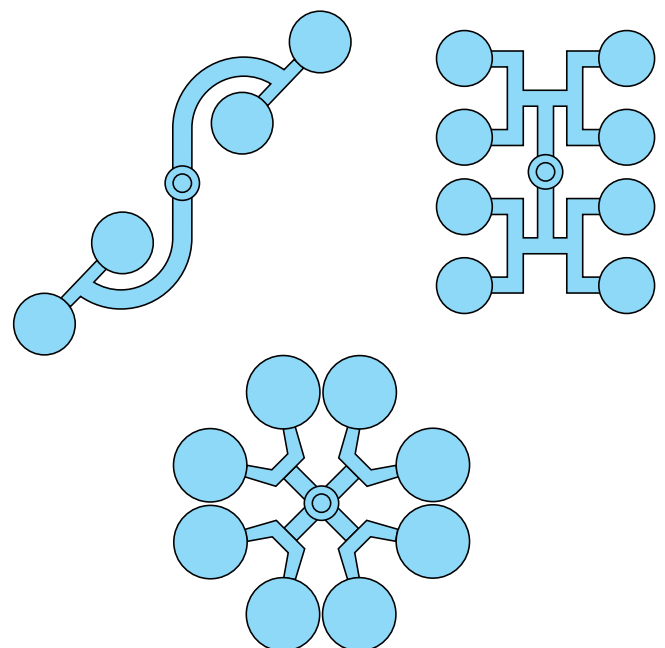

Figure 9.20 Balanced



“Family” molds (tools which incorporate two or more differently sized cavities) are not recommended as they may not fill evenly and may result in unacceptable parts.

Side action

When the part design incorporates detail perpendicular to the direction of mold opening, slides must be used. The slides need to be withdrawn prior to part ejection. Withdrawal of the slides can either be done hydraulically or by using angled pins mounted on the plate opposite the slide as shown in Figure 9.21. When the mold closes, the pin engages the slide, moving it into place. When the mold opens, the pin withdraws from the slide, moving it away from the molded part. Positive angled blocks should be incorporated on both sides to develop additional clamp force. Stops should be used to prevent the slides from moving too far, which can result in tool damage.

Molds for AvaSpire® PAEK are typically operated at temperatures in excess of 170 °C (340 °F). Thermal expansion of the mold and the slides must be considered when establishing operating clearances. The slides may travel freely at ambient temperature, but expand and bind at operating temperature.

Sprue and runner systems

The sprue diameter at the nozzle end of the sprue bushing should be slightly larger than the nozzle orifice. The sprue should be tapered positively toward the parting line at a minimum of 2 degrees. An undercut or “sprue puller” should be placed in the movable platen opposite the sprue to ensure the sprue is removed from the stationary plate on mold opening.

Figure 9.21 Angled pin slide schematic

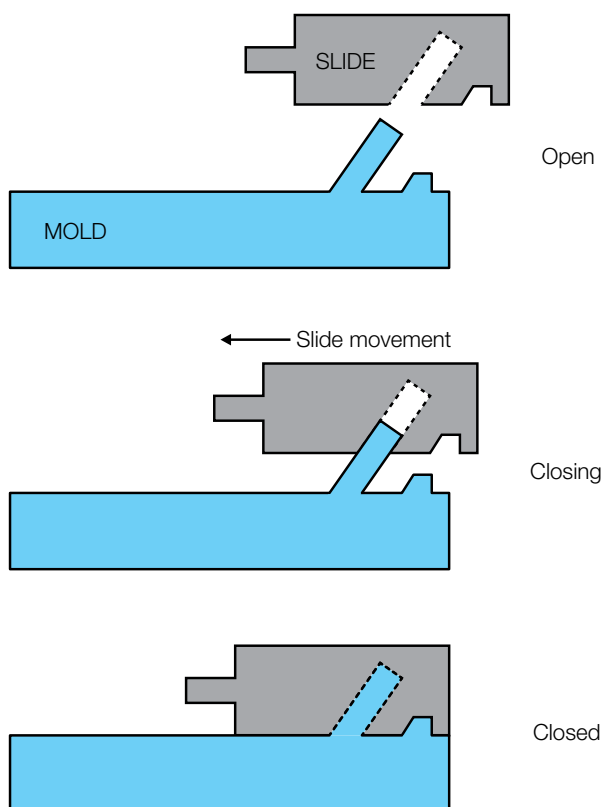

Full round runners are the most efficient; however, trapezoidal runners perform well and are easier to machine. For single-cavity tools, the cross-sectional area of the runner should be identical to the area at the base of the sprue. For multiple-cavity tools, the cross-sectional area of each secondary (and tertiary) runner should be reduced such that the combined area of the secondary runners is equal to the area of the primary runner. This will maintain polymer velocity at each runner split. The runner system should incorporate features to ensure that it remains in the movable mold plate. This is especially important for long runners. Also, the runner should have ejector pins to ensure that the runner system and the molded parts are ejected simultaneously.

Hot runner systems

Hot runner systems offer improved material efficiency; however, they add cost and complexity to the tool. Each drop in a multiple hot runner system should have its own controller. Shut-off valves are not recommended, especially with the fiber-filled resins. Drops designed for use with semi-crystalline materials should be specified.

Mold Shrinkage

The dimensions of a molded part will usually be smaller than the dimensions of the cavity that they were molded in. This is due to the density difference between the molten polymer and the solid polymer, as well as the differences in dimensions due to thermal expansion. The dimensional difference between the mold and the molded part is typically called mold shrinkage. To determine the mold shrinkage, end-gated bars with nominal dimensions of 3.2 × 127 × 12.7 mm (0.125 × 5 × 0.5 inch) were molded and measured. The dimensions were compared to the dimensions of the mold at room temperature. The mold shrinkage values obtained are shown in Table 9.2.

The shrinkage of actual parts will vary depending on the geometry and flow patterns. The unfilled grades will exhibit nearly isotropic shrinkage (the same shrinkage in all directions) while the fiber-filled grades will exhibit anisotropic shrinkage due to orientation of the fibers. The fibers will tend to align in the direction of the flow, resulting in lower shrinkage in that direction.

Figure 9.22 Shrinkage varies with flow direction

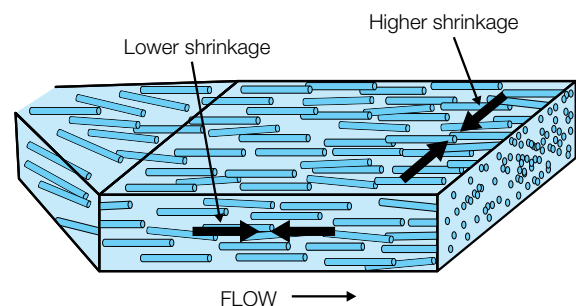

To determine appropriate cavity dimensions, apply the mold shrinkage values to the desired part dimensions. Because actual parts usually have a combination of flow and transverse flows, the actual shrinkage will be between the two values. It is advisable to cut initial steel dimensions “steel safe”, which means to cut cavity dimensions slightly smaller than the anticipated final dimension and to cut cores slightly larger than anticipated. The mold can then be sampled, parts measured and final tool adjustments made.

Table 9.2 Molding shrinkage values of AvaSpire® PAEK

Grade	Molding Shrinkage [%]	
	Flow Direction	Transverse Direction
AV-621 NT	0.7 – 0.9	1.1 – 1.3
AV-651 BG15	0.7 – 0.9	1.0 – 1.2
AV-722 BG20	0.8 – 1.0	1.2 – 1.4
AV-621 GF30 BG20	0.1 – 0.3	0.9 – 1.1
AV-651 GF30 BG20	0.2 – 0.4	1.3 – 1.5
AV-750 GF40 NT	0.1 – 0.3	1.2 – 1.4
AV-848 GF30 NT	0.2 – 0.4	0.5 – 0.7
AV-621 CF30	0.0 – 0.2	0.9 – 1.1
AV-651 CF30	0.0 – 0.2	0.9 – 1.1
AV-722 CF30	0.0 – 0.2	1.4 – 1.6
AV-848 CF30	0.0 – 0.2	0.4 – 0.6
AV-722 SL30	0.1 – 0.3	1.7 – 1.9
AV-742 SL30	0.1 – 0.3	1.6 – 1.8
AV-755 SL45	0.0 – 0.2	1.2 – 1.4

Gating

Gate types

Edge gates are common and generally trouble free; however, they do require a post-molding process for removal. To facilitate runner removal, a slight undercut may be placed in the gate where it meets the part. This will create a notch at the interface to allow a clean break and avoid a gate vestige extending from the part. The gate can also be slightly recessed into the part if the design permits. The use of gate inserts is suggested to allow efficient replacement and repair.

Figure 9.23 Edge gate

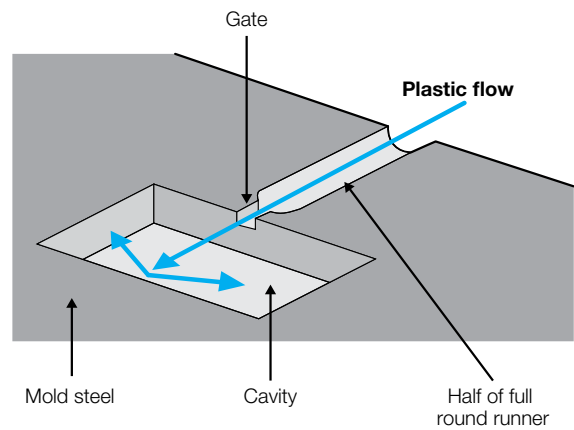

Tunnel or “submarine” gates allow the point of injection to be moved from the parting line and, as such, are self degating.

As shown in Figure 9.24, the angle of the gate (α) should be no more than 30 degrees perpendicular to the parting line for unfilled materials and 25 degrees for the filled grades. Gate inserts are also recommended.

Figure 9.24 Tunnel gate

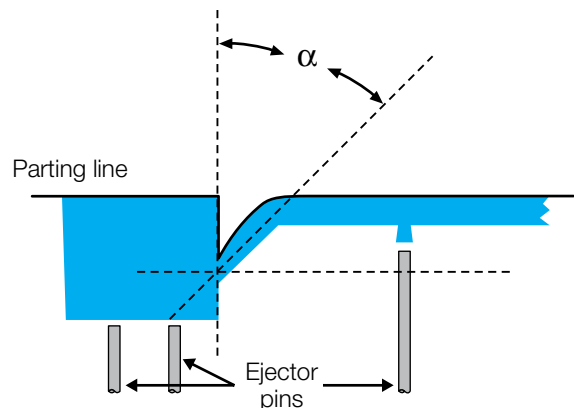

Gate location

Gates are typically located at the thickest section of the part to allow material to flow from thick to thin sections. Other factors to consider when determining gate location include cosmetic requirements, weld line location, and flow-length requirements.

The use of mold-filling software is helpful in determining optimum gate location.

Gate size

Gates dimensions are typically 30 % to 50 % of the wall that they are gated into, but never less than 0.5 mm (0.020 inch). Round gates are most efficient, however, rectangular gates are very common. The use of gate inserts is suggested to facilitate gate modification or replacement without removing the entire tool. Mold filling software can assist in optimizing the gate dimensions.

Venting

Placement of vents in the tool allows the air in the cavity to escape as the resin fills. Inadequate venting may result in burn marks on parts and deposits on the tool steel. Vents should be placed on at least 25 % of the parting line, especially opposite the gate location, which is the area that will be filled last. Vents should also be placed in the locations where weld lines are expected. The runner system should be vented as well. Vents can also be added to ejector pins.

Starting point dimensions for vents would be 0.04 mm (0.0015 inch) deep and at least 1.25 mm (0.05 inch) wide. The vent land should be 1 mm (0.04 inch) long and then open to a relief channel, 2.5 mm (0.10 inch) deep, extending to the edge of the tool.

As it is difficult to observe burns on darker colored materials, it is helpful to process a light-colored (not black) material and observe the parts for burns or visible knit lines to determine if a tool is vented properly. Should burns be present, additional venting is warranted.

Figure 9.25 Vents

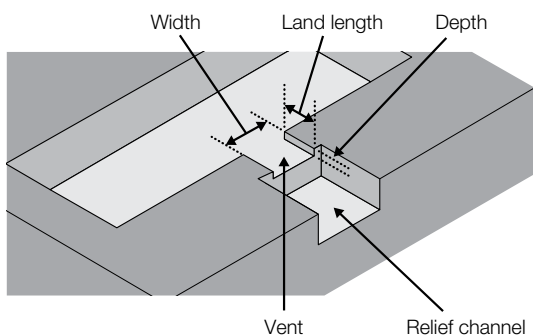

Draft

To allow parts to be easily ejected from the mold cavity, walls perpendicular to the parting line must be angled slightly. This is known as “draft”. Because the polymer will shrink away from external walls, but shrink down onto cores, more draft is required on internal components than on external walls. One degree of draft is recommended on internal surfaces (cores) and 0.5 degree on external surfaces.

Figure 9.26 Draft illustration

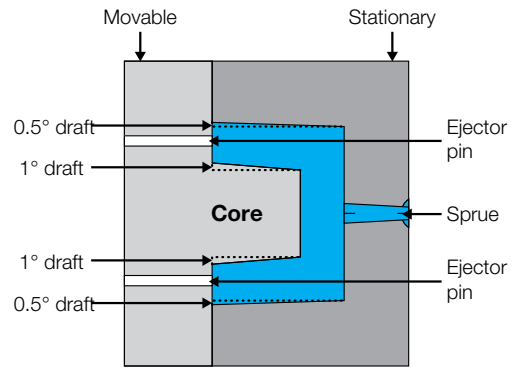

Table 9.3 Draft

Depth of Draw [mm(inch)]	Dimensional Allowance [mm(inch)]	
	Draft Angle 0.5°	Draft Angle 1°
6 (0.236)	0.05 (0.002)	0.10 (0.004)
12 (0.472)	0.10 (0.004)	0.21 (0.008)
18 (0.709)	0.16 (0.006)	0.31 (0.012)
24 (0.945)	0.21 (0.008)	0.42 (0.017)
30 (1.181)	0.26 (0.010)	0.52 (0.020)
Other depths of draw	Multiply value by 0.00873	Multiply value by 0.01745

Occasionally draft requirements will conflict with part function or dimensional tolerance requirements. This is often encountered with circular features with deep draws. For example, a 25 mm (1 inch) diameter hole perpendicular to the parting line in a wall thickness of 12 mm (0.472 inch) would normally require a taper of 1 degree. To get a 1 degree draft would require that the diameter be increased by 0.42 mm (0.016 inch). The value in Table 9.3 for 1 degree draft has to be doubled because the allowance has to be added to both sides. If this is a through hole, the draft can be minimized by using two shorter cores. Putting a core on each side of the mold effectively halves the depth of draw. Therefore, each core would have a draft allowance of 0.10 mm (0.004 inch) per side, with a total diameter increase of 0.20 mm (0.008 inch).

Ejector systems

Most parts can be ejected using a standard ejector pin system. Ejector pins should be located uniformly around the part and the total ejector pin surface area should equal at least 5 % of the part area. Ejector pins should also be located at the deepest parts of the cavity to “push” rather than “pull” the part out of the tool. Ejector pin diameter should be as large as possible to minimize the possibility of deforming the part upon ejection.

For thin-walled parts, flat “blade” ejectors can be used to increase the ejector surface area. A stripper plate can also be used to eject parts that have little surface area available for ejector pins.

For parts that have more surface area perpendicular to the parting line rather than parallel to it, such as a thin-walled tube, it is sometimes desirable to withdraw the cores prior to opening the mold.

Thermal Management

Due to the high-temperature processing requirements of AvaSpire® PAEK, a heat transfer fluid capable of operation up to 260 °C (500 °F) is necessary to control the tool temperature. The high mold temperature is necessary both to allow enough flow to fill the part and to ensure optimal crystallinity of the material. Parts produced with lower mold temperatures may not achieve optimal crystallinity levels and may exhibit decreased chemical resistance, lower strength, and dimensional instability.

The use of electrical heating elements to achieve the appropriate mold temperature is not recommended. The polymer is being injected into the mold at temperatures in excess of 350 °C (660 °F) and it must be cooled to below 200 °C (390 °F) to solidify. Without heat transfer fluid to remove the heat, the mold temperature would continually increase. Electrical heaters may be used in tandem with circulating oil, to speed start-up, but circulating fluid is essential.

Heating/cooling channels should be placed uniformly throughout the tool, preferably close to the cavities to promote efficient heat transfer. For areas where cooling lines are not practical, such as core pins, a thermally conductive (copper beryllium) pin may be inserted into the pin to promote efficient heat transfer.

Using thermal insulation between the mold and the platen is highly recommended, both to reduce the load on the thermal management system and to protect the hydraulics of the molding press.

Drying

AvaSpire® PAEK resins must be properly dried prior to processing. The maximum recommended moisture level for processing AvaSpire® PAEK is 0.1 % (1,000 ppm). Moisture levels can be checked using a conventional loss in weight analyzer. The test conditions for analysis should be 200 °C (400 °F) for 10 minutes, or until moisture is no longer evolved.

A desiccant drier system capable of maintaining a dew point of – 40 °C (– 40 °F) is recommended. Drying for four hours at a temperature of 150 °C (300 °F) is usually adequate, but resin that has been allowed to absorb additional atmospheric moisture may require additional drying time.

In a production environment, the size of the drying system should be such that the proper drying times are achieved. To calculate the residence time in the drier, divide the capacity of the drier by the weight of parts produced in one hour.

Injection Molding Process

The injection molding process can be divided into several phases. Each phase has certain key parameters and controls necessary to maintain a robust process producing consistent, high-quality parts. The phases are:

- **Injection:** After the mold closes, high pressure is applied, forcing the screw forward injecting the polymer from the barrel, through the sprue and runner into the part. Since the polymer begins to freeze as soon as it enters the relatively cool cavity, it is necessary to inject the polymer quickly, but at a controlled rate. This phase is controlled by the forward velocity of the screw and the screw position; 95 % to 98 % of the cavity should be filled on injection.
- **Pack and hold:** In this phase, the pressure is lowered, the balance of the cavity is filled, and the polymer is pressurized in the mold cavity. This is important because the polymer shrinks as it cools and inadequate pressure in this phase may result in internal porosity, cracks, sink marks or high molded-in stress.
- **Screw recovery and cooling:** While the part is cooling in the mold, the screw rotates to prepare the charge for the next shot. A moderate amount of back pressure is used to induce light shear and ensure a uniform melt.
- **Mold open and part eject:** After the part has cooled enough to be ejected without deformation, the mold opens, the part is ejected, and the cycle repeats.

Process Setup

When starting up a new tool, the following procedure can be used to establish a robust molding process. This procedure can also be used to troubleshoot an existing process.

- Set mold and barrel temperatures to the recommended starting point molding conditions shown in Tables 3 and 4.
- Place dried resin in hopper and purge “air shots”. Verify melt temperature with a contact pyrometer. Adjust to achieve target melt temperature if necessary.
- Set transfer position at 0, turn off hold pressure, set injection velocity at desired speed, and set injection pressure at maximum. Set shot size below anticipated value and begin molding short shots.
- Gradually increase shot size to achieve a part that is nearly (about 95 % to 98 %) full. Ensure that maximum pressure is not reached and that injection velocity is attainable. This can be done by monitoring actual pressure to achieve injection velocity as well as mathematically verifying that injection velocity settings are achieved. Divide shot size by injection rate and compare to actual fill time. For example, if the shot size is 100 units and the injection velocity setting is 50 units/second, the fill time should be exactly 2.0 seconds. If the injection pressure reaches maximum, the machine is not capable of achieving the injection velocity setting. Reduce the injection velocity setting until the injection pressure is below maximum.
- Estimate the amount of additional shot volume necessary to complete the filling of the part and achieve an acceptable cushion. Add that amount to the full shot position and set the transfer point to that value. For example, if a setting of 100 fills 98 % of the part with no cushion and you estimate that adding 20 will provide the completion of the fill and give a cushion, then set the full shot position to 120 and set the transfer point to 20.
- Set hold pressure to 50 % of the injection pressure at transfer position. Observe molded parts and ensure that a cushion is maintained. Adjust full shot and transfer positions if necessary. Increase hold pressure and time to achieve maximum part weight without flash.
- Make any necessary adjustments to ensure a smooth injection and transition to hold pressure at the transfer position while maintaining an acceptable cushion.

Process control

Once an injection molding process has been established to produce an acceptable part, controls must be placed on the process to ensure repetition and alarms set to warn of impending changes before an unacceptable part is molded. Three parameters on the molding machine can be monitored and alarmed to alert that the molding process is in, or is moving toward, an unacceptable condition:

- **Fill time:** Since this parameter is controlled by velocity, the fill time (time from full shot to transfer position) should be absolutely constant. Erratic fill times would indicate that the machine is pressure limited, not velocity controlled.
- **Final cushion position:** The final position of the screw at the end of the hold phase indicates the polymer volume that has been injected into the mold cavity and, as such, should also be absolutely constant.
- **Pressure at transfer position:** Since the injection phase is controlled by velocity and position, the amount of pressure required to achieve the injection velocity (pressure at transfer position) is related to the viscosity of the polymer. Sudden changes in the viscosity of the polymer would indicate a problem with either the polymer or molding machine.

Slight variations in pressure are to be expected; however, a variation of more than 10 % of the average should trigger an alarm. Usually a 10 % variation in pressure will not be enough to alter fill time or final cushion position, so the machine is essentially alarming a potential problem before defective parts are molded.

Starting Point Molding Conditions

Table 9.4 Starting point molding conditions for AvaSpire® AV-600 Series

Parameter	Unit	Unfilled Grades	Fiber Reinforced Grades
Mold temperature	°C (°F)	150 – 180 (302 – 356)	160 – 190 (320 – 374)
Rear zone temperature	°C (°F)	355 (671)	365 (690)
Middle zone temperature	°C (°F)	365 (690)	371 (700)
Front zone temperature	°C (°F)	371 (700)	377 (710)
Nozzle temperature	°C (°F)	374 (705)	382 (720)
Target melt temperature	°C (°F)	371 (700)	377 (710)
Injection speed		Moderate to fast, 5 – 10 cm/sec (2 – 4 inch/sec)	Moderate, 2.5 – 7.5 cm/sec (1 – 3 inch/sec)
Injection pressure		Adequate to achieve injection velocity	Adequate to achieve injection velocity
Hold pressure		50 – 70 % of pressure at transfer position	50 – 70 % of pressure at transfer position
Back pressure	bar (psi)	35 (500)	20 (300)
Screw speed		75 to 100 rpm	75 to 100 rpm

* CF and SL grades have high thermal conductivity and therefore may require higher nozzle temperatures to prevent nozzle freeze-off.

Table 9.5 Starting point molding conditions for AvaSpire® AV-700 Series

Parameter	Unit	Unfilled Grades	Fiber Reinforced Grades
Mold temperature	°C (°F)	177 – 204 (350 – 400)	177 – 204 (350 – 400)
Rear zone temperature	°C (°F)	350 (662)	360 (680)
Middle zone temperature	°C (°F)	360 (680)	365 (690)
Front zone temperature	°C (°F)	365 (690)	370 (700)
Nozzle temperature	°C (°F)	368 (695)	376 (709)*
Target melt temperature	°C (°F)	365 (690)	370 (700)
Injection speed		Moderate to fast, 5 – 10 cm/sec (2 – 4 inch/sec)	Moderate, 2.5 – 7.5 cm/sec (1 – 3 inch/sec)
Injection pressure		Adequate to achieve injection velocity	Adequate to achieve injection velocity
Hold pressure		50 – 70 % of pressure at transfer position	50 – 70 % of pressure at transfer position
Back pressure	bar (psi)	35 (500)	20 (300)
Screw speed		75 to 100 rpm	75 to 100 rpm

* CF and SL grades have high thermal conductivity and therefore may require higher nozzle temperatures to prevent nozzle freeze-off.

Start-Up, Shut-Down and Purging

If processing less thermally stable polymers, it is critical to completely purge out all of the previous polymer prior to running these resins. This can be done in a stepwise fashion by bringing the barrel up to an intermediate temperature and purging until there is no trace of the previous material. Empty the barrel and bring the barrel temperatures up to processing temperatures. When the proper processing temperatures are reached, purge with AvaSpire® PAEK until a clean extrudate is obtained.

Shut-Down Procedure

If a shut-down is required during a molding run, certain precautions should be taken. It is not good practice to allow resin to sit stagnant for prolonged periods of time at molding temperatures. If the shut-down is of a short duration (one hour or less), empty the barrel and purge several shots before restarting. For shut-downs of several hours, the barrel temperatures should be reduced to 338 °C (640 °F) or less. The barrel should be heated to normal processing temperatures and purged with the resin before continuing.

For extended shutdowns, empty the barrel of resin, turn off the barrel heaters, and allow the machine to cool to room temperature. To start-up the next day, heat the barrel to the proper processing temperatures and purge with AvaSpire® PAEK until a clean extrudate is obtained.

Purging

Purge materials must be stable at the temperatures used for processing AvaSpire® PAEK. Suitable purge compounds are commercially available. Adequate ventilation is required to remove any fumes from the purge materials. Empty the barrel of resin and begin to feed purge material. Purge until no resin is evident in the extrudate. Reduce the barrel temperatures to the normal processing temperature of the purge material, and continue to purge several shots. Empty the barrel and allow it to cool.

Annealing

Annealing is typically not required after molding; however, certain parts or applications may benefit from annealing as it can reduce molded-in stress and increase crystallization. To anneal parts made from AvaSpire® PAEK, place the parts in an air circulating oven set at 200 °C (392 °F) for two to four hours. Once the annealing step is complete, allow the parts to cool naturally; do not quench hot parts.

Regrind

When permitted, regrind may be used at levels of up to 25 % with negligible effect on properties. The following should be considered when using regrind:

- **Contamination:** Use only clean sprues, runners and rejected parts. Material purgings, parts with burn marks or other visual defects should not be used.
- **Classify by size:** The ground material should be size classified to ensure that the regrind is the same size as the virgin pellets. Oversized particles and fines (dust) can melt differently than properly-sized particles and may result in processing issues.
- **Dry:** The regrind should be dried. Preferably, the regrind will be consumed shortly after molding; however, if considerable time has elapsed since molding, the material will absorb moisture and will require the same drying regimen as recommended for the virgin pellets.
- **Blend:** The regrind should be blended completely with virgin pellets to ensure uniform processing.
- **Use consistent amounts:** It is best to use a consistent amount of regrind. Varying regrind levels from day to day can result in processing inconsistencies.

If regrind is to be used, it is advisable to submit parts containing regrind for initial inspection and testing.

Table 9.6 Injection molding troubleshooting guide

Problem	Probable Causes	Suggested Remedies
Brittle parts	Degraded material	Lower barrel temperature
		Shorten residence time (may require a smaller press)
		Decrease screw speed
Molded-in stress		Raise barrel temperature
		Extend cooling time
		Raise mold temperature
Burn marks	Insufficient venting	Increase vent depth
		Add venting to problem areas
		Reduce injection speed
Flash	Clamp pressure too low	Increase clamp force (may require a larger press)
		Reduce injection speed
Short shots	Insufficient material injected	Increase shot size
		Increase injection pressure
		Raise mold temperature
		Increase injection speed/fill rate
Voids	Insufficient pressure	Increase injection speed
		Increase holding pressure
		Extend holding time
		Decrease transfer position
		Increase gate area
Warping/distortion	Insufficient/uneven cooling	Lengthen cooling time
		Raise mold temperature
		Reduce injection speed
		Make wall thickness uniform
		Part or mold design

Extrusion

AvaSpire® polyaryletherketone (PAEK) resins can be easily extruded into a variety of shapes using standard extrusion equipment suitable for processing high-temperature semi-crystalline materials. The extrusion process can be used to produce films, sheets, simple profiles, complex profiles, and hollow profiles.

Extrusion Materials

Several grades of AvaSpire® PAEK have been developed specifically for extrusion. High viscosity grades, including fiber-reinforced and wear-resistant grades, are suitable for the production of articles with large cross sections. Thin profiles and films may be produced from the lower or intermediate viscosity grades, which are typically unfilled. Filled grades are not usually extruded into thin profiles or films.

Equipment for Extrusion

All extrusion processes require similar equipment as well as a downstream method of handling the extrudate, which depends on the article being extruded.

Dryer

AvaSpire® PAEK resins must be dried before extrusion. Because extrusion is a low-pressure forming process, a moisture content of less than 200 ppm (0.02 %) is required. A desiccated dryer capable of maintaining a temperature of 150 °C (302 °F) at a dew point of -40 °C (-40 °F) is necessary to achieve the required moisture content. Either a desiccated hopper dryer or a desiccated oven may be used.

Feeder

In most cases, conventional flood feeding (loading the resin into a hopper directly above the extruder) is used. In some cases, such as when extremely tight dimensional tolerances are required on small profiles, a starve feeding method may be employed. In this method, a gravimetric feeder is used to slowly meter the resin to the extruder which is run at high rpm. This method can also be used on larger extruders to minimize residence time in the extruder barrel.

Extruder

Conventional extruders are suitable for processing AvaSpire® PAEK. They should be capable of operating at temperatures up to 450 °C (840 °F) and be constructed of materials suitable for operation at these temperatures. The size of the extruder should be appropriate for the cross-sectional area of the extrudate desired.

Single screw extruders are generally used, though twin screw extruders may offer improved dimensional tolerances. A single screw extruder should have a screw with a length to diameter (L/D) ratio of 24 to 30:1. The compression ratio, the flight depth of the feed section divided by the flight depth in the metering section, should be between 2.0:1 and 3.0:1.

The screw should have three distinct sections: a feed section, a transition section, and a metering section. Each section should have the same number of flights and the flight depth in the feed section should be at least 6 mm (0.24 inch). The screw and barrel liner should be constructed of materials suitable for use at temperatures up to 450 °C (840 °F), such as Xaloy® X-800 or CPM® 9V® tool steel.

Figure 9.27 Extruder screw schematic

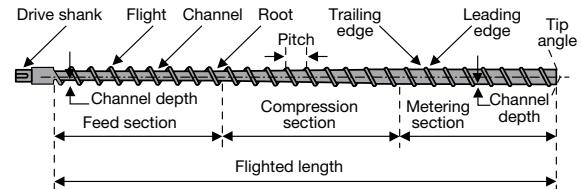

Adapter and die

The adapter and die should be constructed of material suitable for operation at the processing temperatures of AvaSpire® PAEK, such as AISI S7 or H13 steel or equivalent, and they should be air hardened to a minimum Rockwell Hardness value of HRC50. Because AvaSpire® PAEK is not corrosive, no special alloy or coating is required.

The adapter and die should be designed for smooth polymer flow as shown in Figure 9.28. Sharp corners and step changes lead to low-flow areas where the polymer can stagnate and thermally degrade. In general, the cross-sectional area of the flow path from entry to the adapter to the exit of the die should continually decrease. The die land length (the length of the constant cross-sectional area at die exit) should be 10 times the largest thickness dimension of the extrudate. For very large cross-sectional area profiles, a shorter land length may be used.

Additional die considerations are discussed in each section.

Figure 9.28 Adapter design

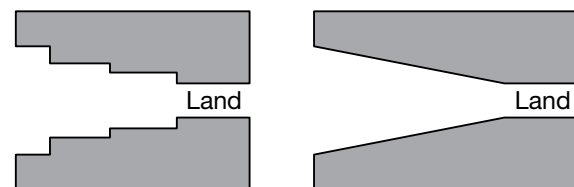

Take Off Equipment

Depending on the type of profile being extruded, different types of equipment are necessary to form or hold the form of the extrudate. This includes calendar rolls for films and thin sheet, a vacuum calibrator for tubing, and fixtures for profiles. These methods are discussed in the appropriate sections.

Starting Point Process Conditions

Drying

AvaSpire® PAEK resins must be dried before processing. This can be accomplished in a desiccated oven maintaining a dew point of $-40\text{ }^{\circ}\text{C}$ ($-40\text{ }^{\circ}\text{F}$) at a temperature of $150\text{ }^{\circ}\text{C}$ ($302\text{ }^{\circ}\text{F}$) for a period of at least four hours. Measured moisture content should be no greater than 200 ppm (0.02 %). Since extrusion is a low-pressure forming process, resin that is not dried properly can result in a foamed extrudate.

Temperature Setup

Table 9.7 Starting point temperatures

Zone	Temperature [$^{\circ}\text{C}$ ($^{\circ}\text{F}$)]
Extruder rear (feed) zone	355 (671)
Extruder middle zone	365 (689)
Extruder front zone	375 (707)
Adapter	370 (698)
Die	375 (707)

Startup

Starting with a clean extruder is essential. Most other polymers will degrade very quickly at AvaSpire® PAEK processing temperatures and create black specks. A complete teardown and cleaning is recommended before processing.

Once the processing temperatures have been achieved, it is desirable to wait for at least one hour to ensure that all components are uniformly heated.

To start processing, add the material to the hopper and set the screw to a low to moderate speed. Observe die pressure and extruder torque until the polymer begins to exit the die. If excessive pressures or torques are observed, reduce the screw speed and increase temperatures where necessary. Excessive die pressure indicates low temperatures in the die, adapter and front extruder zone. Excessive screw torque indicates low temperatures in the extruder rear (feed) and middle zones.

If possible, measure the melt temperature with a contact pyrometer. Typically, a target melt temperature of $370\text{ }^{\circ}\text{C}$ to $375\text{ }^{\circ}\text{C}$ ($698\text{ }^{\circ}\text{F}$ to $707\text{ }^{\circ}\text{F}$) is desired.

Shut-Down

If a shut-down is required during a production run, certain precautions should be taken. It is not good practice to allow resin to sit stagnant for more than 20 minutes at temperature.

At the end of a run, shut off the flow of material to the extruder. Continue to rotate the screw until material stops flowing through the die. Stop the extruder screw. When ready to resume operations, purge until extrudate runs clean.

Purging

With the exception of thin-film dies, most extrusion processes can be purged with the die attached. When producing thin films, it is usually advisable to remove the die before purging.

Purge materials should be stable at the elevated temperatures used to extrude AvaSpire® PAEK. Materials such as polysulfone, polyetherimide, and fractional melt flow high density polyethylene (HDPE) may be used. Adequate ventilation is required to remove any fumes from the purge materials. Empty the barrel of PAEK resin and begin to feed purge material. Purge until no PAEK resin is evident in the extrudate. Reduce the barrel temperatures to the normal processing temperature of the purge material and continue to purge. Empty the barrel and allow it to cool.

Sheet and Film Extrusion

Unfilled AvaSpire® PAEK grades may be extruded into thin films and sheet. Films as thin as 0.025 mm (0.001 inch) have been produced. Most conventional dies may be used. Die design uses a coat hanger geometry as shown in Figure 9.29. As a rule of thumb, the die land length (distance of constant thickness) should be 10 times the finished film thickness.

When producing thin films, it is advisable to utilize a breaker plate and screens between the extruder and adapter. The breaker plate should be chamfered to allow smooth flow. Typical screen packs would use one or more screens from 60 mesh to 200 mesh supported by a heavier screen, such as 20 mesh.

The die opening should be slightly larger, but very close to the desired finished thickness. The film is typically fed through a three-roll stack with the clearance between the rolls set at the desired film thickness. To produce fully crystallized films, the roll temperatures should be set at a temperature of $149\text{ }^{\circ}\text{C}$ to $170\text{ }^{\circ}\text{C}$ ($300\text{ }^{\circ}\text{F}$ to $338\text{ }^{\circ}\text{F}$).

Figure 9.29 Coat hanger film die conceptual lower die plate

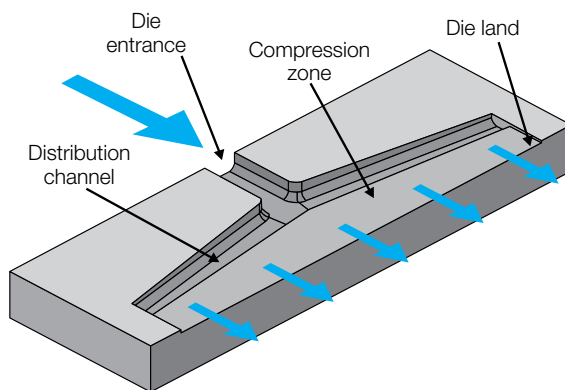

Tube Extrusion

AvaSpire® PAEK resins may be fabricated into tubes using conventional extrusion equipment designed to process high-temperature, semi-crystalline polymers.

Tooling for tubing extrusion includes a spider plate to which the inside diameter forming mandrel or pin is attached and a die that fits over the pin as shown in Figure 9.30.

The draw down ratio (DDR) for extrusion dies should be from 1.1 to 1.3 to 1 with the lower draw being used for larger, thicker tubes and the higher ratio for thinner, smaller tubes. The draw down balance (DDB) should be from 1.0 to 1.1:1.

The extruded tube is sized in a water-cooled, vacuum calibrator that is in very close proximity to the die exit. Due to the rapid cooling of the tube in the calibrator, a post annealing step is advisable. This can be accomplished as a post process or in-line with an oven set to 170 °C (338 °F). Tubes may either be cut into desired lengths or coiled, as in the case of thin-walled tubing.

Figure 9.30 Tubing die

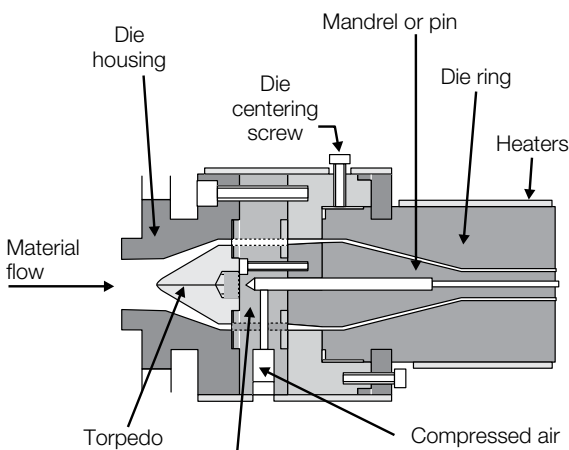

Profile Extrusion

Rod and slab stock shapes as well as complex geometry profiles can be extruded from AvaSpire® PAEK. Generally the cross-sectional thickness is limited to 50 mm (2 inches). Larger cross-sectional profiles have been successfully extruded, however, they are prone to cracking and internal porosity.

Die design for profiles should be simple, with no dead spots where material could hang up in the die and degrade. The cross-sectional area of the melt flow path inside the die should continuously and uniformly decrease from the entrance of the die to the exit. The die land length (length of the constant cross-sectional area at the die exit) should be 10 times the profile's thickest cross section. A typical profile die is shown in Figure 9.32.

Die temperature control is critical for profile extrusion as is extrusion rate. The temperature of the extrudate should be just below the melting point of the polymer on exit from the die. This allows the extrudate to hold its form. The extrusion rate should be adjusted such that the extrudate flows out of the die in a solid form, but does not freeze off inside the die. If the extrudate exits the die in a molten form, the extrusion rate should be slowed and/or the die temperature reduced. A slip stick condition would also warrant a similar resolution.

The downstream handling apparatus depends on the nature of the profile. Simple profiles such as rod or slab can be simply cooled gradually inside a metal forming chamber which should be sized slightly larger than the profile. The length of the cooling chamber should be at least 20 times the profile cross section. Complex profiles would require forming fixtures to ensure that the profile holds correct shape and dimension. The fixtures should allow for slow and uniform cooling.

Figure 9.31 Typical three-roll stack

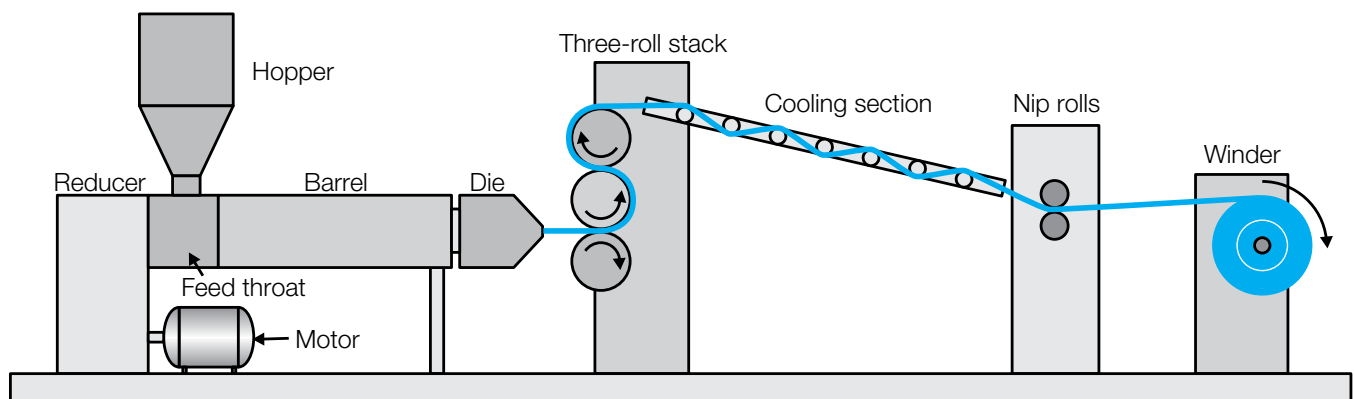
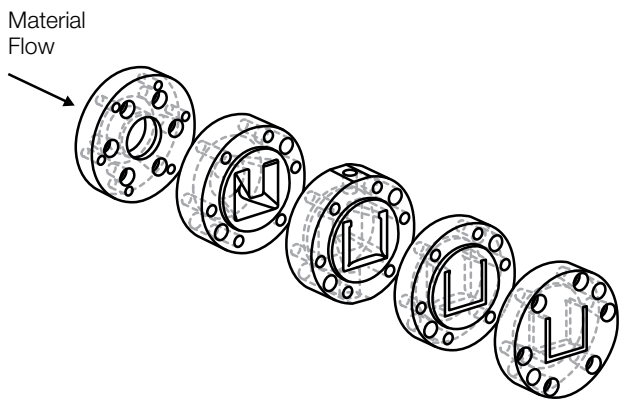

Figure 9.32 Typical profile extrusion die



Most profiles are drawn from the extruder by a downstream puller. The speed of the puller should be adjusted to maintain enough pressure in the die to fully form the profile. In the case of large cross-sectional profiles, the puller actually functions as a brake and should be mechanically fastened to the extruder. The profile may be cut to the desired length by a saw after the puller.

Filament

Filaments may be extruded using unfilled AvaSpire® PAEK resins. Filament diameters from 0.125 mm (0.005 inch) to 2.5 mm (0.100 inch) can be produced by pulling from a die with an exit diameter of 1.1 to 1.3 times the desired filament diameter. The extrudate should be pulled from the die in the molten state and drawn to the desired diameter. The filament should be preferably air cooled to achieve optimum crystallinity.

Fine Fiber

Fibers with diameters as small as 12 micrometers (2.5 denier) have been successfully produced using AvaSpire® PAEK. Fiber spinning involves an extruder with a melt pump supplying a multi-hole die at a constant pressure. The extrudate is pulled from the die by a rotating cylinder called a godet roll, drawing the fiber to the desired diameter. The fiber may be drawn further on subsequent godet rolls, as well as annealed at a godet roll temperature of 200 °C (392 °F) before being wound on a reel as shown in Figure 9.33. The ratio of post-extrusion draw and annealing steps determines the balance of tensile and elongation properties.

Figure 9.33 Fiber spinning process

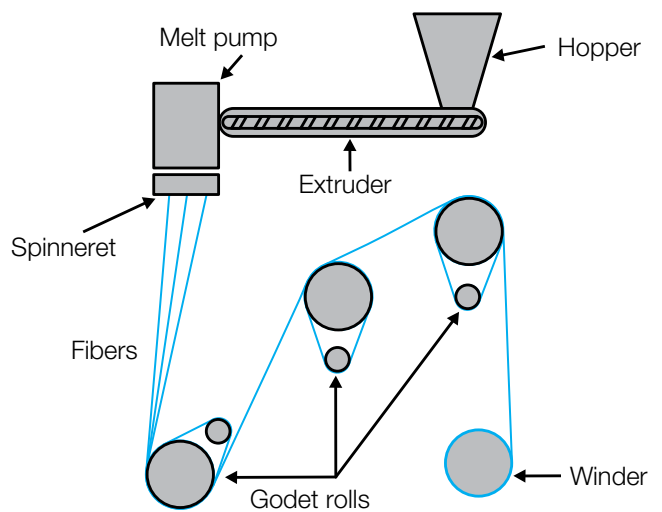

Table 9.8 Extrusion troubleshooting guide

Problem	Possible Cause	Remedy
No extruder output	Hopper feed throat bridge (material sticking in feed throat)	Cool hopper feed throat jacket Clean feed throat coolant channel
	Complete screw bridge (melting in feed section)	Cool rear barrel heat zone to 340 °C (644 °F) or lower if necessary Cool hopper feed throat jacket Select metering type screw with compression ratio of 2.0 to 3.0:1 and feed zone depth of at least 6 mm (0.24 inch) Calibrate rear barrel heat zone controller
Excessive extruder drive power requirement	Rear heat zone barrel temperature too low	Increase rear zone barrel temperature
	Barrel temperature in transition zone too low	Increase temperature of middle heat zone
	Melt temperature too low	Increase all barrel temperatures Increase screw rpm to increase shear
Surging	Screw design	Select screw with metering zone, compression ratio 2.0 to 3.0:1, feed zone at least 25 % of length, with gradual transition
	Partial screw bridge	Cool hopper feed throat jacket
	Extruder drive variation	Check drive performance
	Variation in haul-off unit	Set belts for positive grip Check haul-off unit for mechanical and electrical malfunction
Bubbles in melt	Partial screw bridging starve feed (entrapped air)	Cool hopper feed throat jacket
	Excessive moisture	Dry the resin
		Reduce melt temperature
		Keep hopper covered
		Use nitrogen purge in hopper
Dry natural resin, concentrate, or regrind in desiccated dryer		
Surface defects	Water splashing in air gap	Eliminate splash or shield splash Move cooling trough further away from die
	Air bubbles in quench water	Improve quench water circulation
Smeared, elongated bubbles (rough surface)	Excessive moisture	Dry the resin
Dull surface	Resin melt viscosity too high	Select resin with lower melt viscosity
	Melt temperature too low	Increase melt temperature
	Short air gap	Increase air gap
Poor dimensional control	Surging	See surging section above
Distortion	Inadequate cooling	Use colder quench water
		Circulate quench water efficiently
		Consider use of water cooling ring
		Reduce melt temperature
Poor weld line strength	Poor purge from previous resin	Use variable speed purge procedure
		Streamline to allow effective purging
	Melt temperature too low	Increase melt temperature
	Poor in-line die spider design	Streamline spider design
Poor die design	Increase die land length	

Table 9.8 Extrusion troubleshooting guide

Problem	Possible Cause	Remedy
Excessive shrinkage	Excessive cross-sectional area drawdown	Decrease drawdown
	Melt temperature too low	Increase melt temperature
	Resin melt viscosity too high	Select resin with lower melt viscosity
Degradation	Excessive resin holdup	Increase extruder output Streamline flow paths in adaptor and die
	Poor shutdown procedure	Reduce temperatures before shutdown Purge to clear degradation
	Excessive temperature	Check temperature control systems
	Poor purge from previous heat sensitive resin	See poor purge section above
Carbon specks	Excessive resin holdup	Streamline flow paths in adaptor and die
	Dirty equipment	Extruder/adaptor/die cleaning Avoid shutdown at high temperature
	Excessive temperature	Check temperature control systems

Wire and Cable Extrusion

AvaSpire® polyaryletherketone (PAEK) resins can easily be extruded onto wire or cable using standard extrusion equipment and processing conditions suitable for semi-crystalline materials. AvaSpire® AV-630, designed specifically for wire coating extrusion, offers excellent melt strength yet can be fabricated into very thin 0.025 mm (0.001 inch) coatings.

Equipment for Wire and Cable Extrusion

Extruder

AvaSpire® PAEK resins can be processed on conventional extrusion equipment designed and constructed to operate at temperatures of 450 °C (840 °F). Single-screw extruders are generally used, though twin-screw extruders may offer improved dimensional tolerances.

A suitable single-screw extruder would typically have a length to diameter ratio of 24 to 30 : 1 and the screw compression ratio will range from 2.5 to 3.0 : 1. The screw will usually contain 3 zones : 1/3 feed, 1/3 transition, and 1/3 metering. Flight depth in the feed zone should be at least 6 mm (0.240 inch).

A breaker plate with a screen pack should be used to help develop back pressure. The holes in the breaker plate should be chamfered to allow smooth flow. A screen pack is typically used to remove impurities or contamination. Suitable screens would be from 100 to 200 mesh with a support screen of 20 mesh against the breaker plate. Screens should not be so fine as to create excessive pressure or shear on the material.

Adapters and dies should be constructed of suitable materials such as S7 or H13 steel and hardened appropriately. Adapters and dies should be streamlined to avoid dead spots.

Figure 9.34 Typical wire extrusion equipment

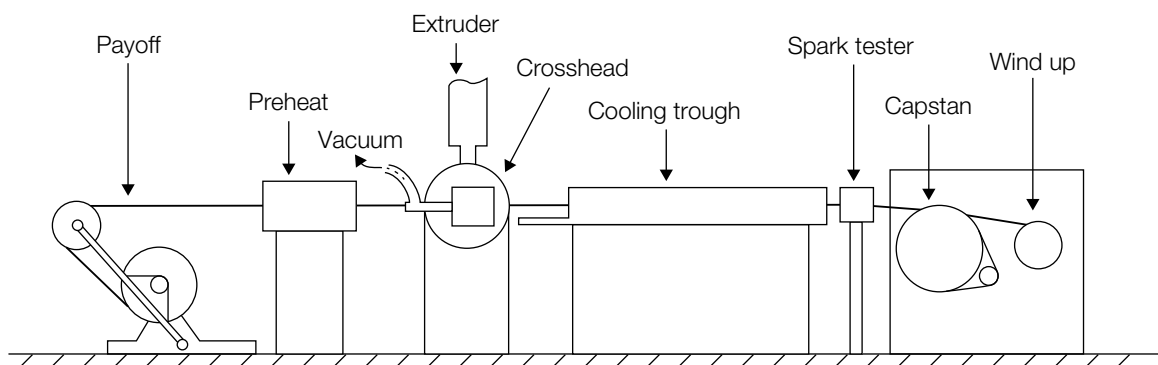

Die and crosshead design

Either a pressure (Figure 9.35) or a sleeve (Figure 9.36) extrusion die can be used for wire coating.

Pressure extrusion is suitable for coatings which include geometry on the exterior of the profile or when several wires are coated and need to be separated by the insulation. In pressure extrusion, the die opening is the same as the desired profile.

More common is sleeve extrusion, in which the die opening is larger than the wire to be coated. Sleeve extrusion allows for thinner coatings than pressure extrusion and generally yields a more uniform insulation.

Figure 9.35 Schematic of pressure die

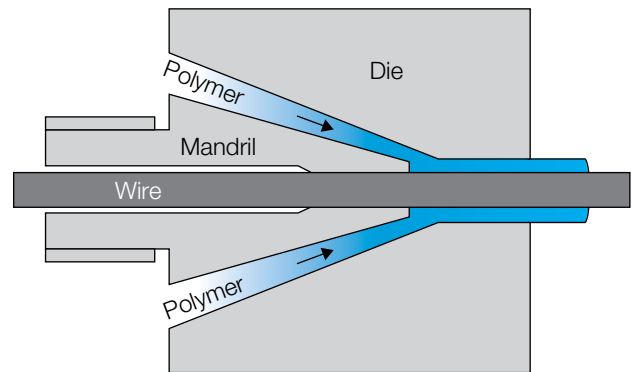
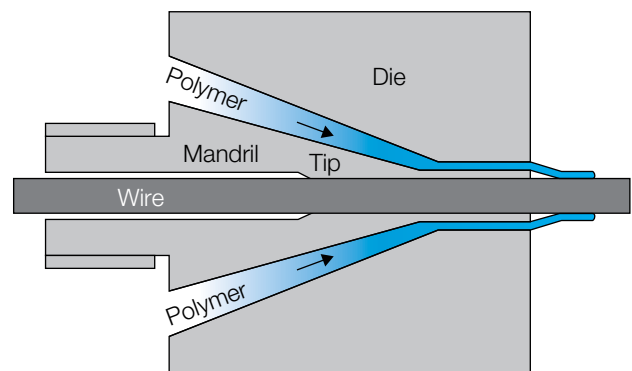

Figure 9.36 Schematic of sleeve die



Draw down ratio

To determine the dimensions of the die opening, the Draw Down Ratio (DDR) is used. The DDR is calculated by :

$$\text{DDR} = \frac{D^2 - T^2}{O^2 - I^2}$$

Where:

D = Die diameter

T = Tip diameter

O = Coated wire outside diameter

I = Bare wire diameter

Draw down ratios of 4 : 1 to 10 : 1 are appropriate for AvaSpire® PAEK resin. Higher ratios may be more suitable for very thin insulations.

Figure 9.37 Sleeve die draw down ratio

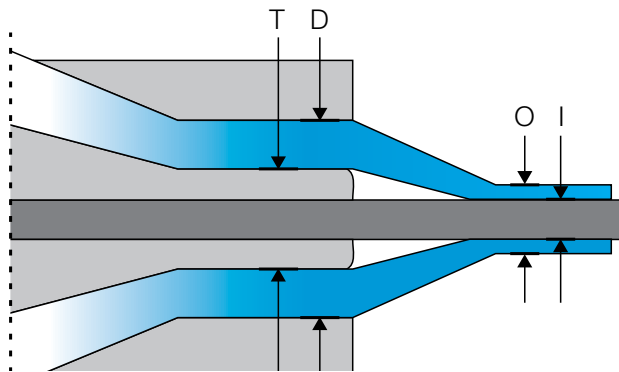

Downstream equipment

A cooling trough is usually used to remove excessive heat from the coated wire before winding. To achieve adequate polymer crystallinity, an air gap of 1 meter to 2 meters (3 feet to 6 feet), depending on extrusion speed, is recommended between the crosshead and cooling trough water bath.

An in-line spark tester with an alarm is useful to alert the operator of a process upset.

Processing

Drying

AvaSpire® PAEK resin must be dried to a moisture content of less than 200 parts per million (ppm) before processing. Drying for at least 4 hours at 150 °C (302 °F) in a desiccated oven or drier capable of maintaining a dew point of -40 °C (-40 °F) will yield a resin dry enough to process properly.

Temperature setup

Starting point temperature settings are shown in Table 9.9. Slight modifications may be needed based on equipment and conditions.

Table 9.9 Starting point temperatures

	°C	°F
Extruder rear (feed) zone	360	680
Extruder middle zone	370	700
Extruder front zone	380	715
Adapter	380	715
Die	385	725

Wire Preheating

It is usually desirable to preheat the wire immediately prior to extrusion. This serves to clean the wire as well as to promote good insulation to wire contact and achieve adequate polymer crystallinity. Wire preheat temperatures will depend on the type of conductor used, but generally temperatures from 125 °C to 200 °C (257 °F to 392 °F) will provide acceptable results.

Startup

Starting with a clean machine is recommended. If processing less thermally stable polymers prior to running these resins, it is critical to completely purge out the previous polymer. This can be done in a step-wise fashion by bringing the barrel up to an intermediate temperature and purging with a fractional melt flow high-density polyethylene (HDPE) or a commercial purging compound until there is no trace of the previous material. Empty the barrel and bring the barrel temperatures up to processing temperatures. When the proper processing temperatures are reached, purge with AvaSpire® PAEK until a clean extrudate is obtained.

Shut-down

If a shut-down is required during a production run, certain precautions should be taken. It is not good practice to allow resin to sit stagnant for a long time (more than 20 minutes) at temperature. At the end of a run shut off the flow of material to the extruder. Allow the screw to remain on until material stops flowing through the die. Stop the extruder screw. When ready to resume operations, purge until extrudate runs clean.

Purging

Purge materials must be stable at the temperatures used for processing AvaSpire® PAEK. Suitable purge compounds are commercially available. Adequate ventilation is required to remove any fumes from the purge materials. Empty the barrel of PAEK resin and begin to feed purge material. Purge until no PAEK resin is evident in the extrudate. Reduce the barrel temperatures to the normal processing temperature of the purge material, and continue to purge. Empty the barrel and allow it to cool.

Table 9.10 Troubleshooting wire and cable extrusion

Problem	Possible Cause	Remedy
Poor surface finish	Melt temperature is low	Increase barrel and head temperatures Use higher shear screw
	Melt fracture	Increase barrel and head temperatures Use lower draw-down ratio Reduce extrusion rate
	Extrusion outer diameter too low	Reduce line speed Increase extruder rpm Change to smaller die (run with slight die swell)
	Improper filling of the die	Use smaller size die
	Porosity	Compound wet Color master batch wet Melt temperature too high (decomposition of material)
High shrinkage	Draw-down ratio too high	Reduce draw-down ratio
Surging extrudate	Insufficient back pressure in extruder	Increase screen packing
	Screw speed too high	Reduce screw speed
	Porosity in extrudate	See Porosity above.
Die drool	Polymer sticking to die	Use highly polished die Adjust die temperature
	High motor amps	Insufficient motor rating Incorrect screw design Screen pack too harsh Head design restrictive Material too stiff

Secondary Operations

Joining

Creating assemblies that include AvaSpire® polyaryletherketone (PAEK) molded parts is often desirable. Mechanical assembly techniques using fasteners, press-fits, or snap-fits can be done and are discussed elsewhere. This document deals with joining parts using thermoplastic welding or adhesive bonding.

The thermoplastic nature of AvaSpire® PAEK can be used advantageously to join parts by welding, thermally softening the surfaces to be joined, forcing them together, and cooling them.

Welding

The welding processes differ in the manner that the bonding surfaces are heated. Welding AvaSpire® PAEK requires more energy than welding other plastics because of its high melting point. Common welding techniques suitable for AvaSpire® PAEK include spin welding, vibration welding, ultrasonic welding, and laser welding. Hot plate and IR welding are rendered more difficult by the high melting point of AvaSpire® PAEK and therefore are not suggested. All welding operations employ some form of energy to melt the polymer at the desired interface. The energy is then removed and the polymer cools to form the bond joining the two pieces. Properly designed and executed, bond strength equivalent to the strength of the polymer can be achieved by welding. Even for reinforced grades, the maximum bond strength is that of the unfilled polymer, because the reinforcing fiber doesn't flow enough to be part of the weld.

Spin welding

In the spin welding process, frictional heat is generated by holding one part stationary and rotating the other at high speed while applying pressure. The frictional heat generated melts the mating surfaces, and then, while maintaining the pressure, the rotation is stopped. When the part cools, the weld solidifies. The key parameters for spin welding are linear velocity, pressure and time.

Figure 10.1 Typical spin weld joint designs

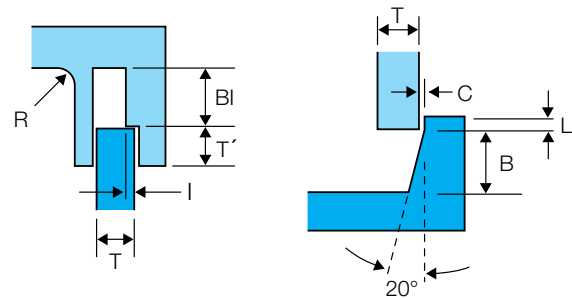

Where:

T = Wall thickness

B = $1.5 \times T$

C = Clearance ~0.1 mm (0.005")

R = Radius ~1.3 mm (0.050")

L = Lead-in 0.5 to 1.0 mm (0.020 to 0.040")

I = Interference 0.25 to 0.51 mm (0.010 to 0.020")

During the welding process, some molten polymer may be squeezed out, creating flash at the weld line. This can be minimized by reducing the pressure when the polymer starts to melt. Spin welding is suitable for parts that are axis symmetrical at the weld.

Vibration welding

The vibration welding process can be used to join complex assemblies. For each assembly to be welded, a fixture must be designed and fabricated. In this process, one part is held stationary and the other is vibrated at 240 Hz (120 Hz for very large parts) while applying pressure. The vibration causes frictional heat to be generated at the interface, melting the polymer. Once a melt is established, the vibration is stopped and pressure held until the polymer solidifies. The main process parameters for the vibration welding process are the amplitude of vibration, the pressure during the vibration phase, the pressure and time after ("holding" phase) and the vertical displacement of one part with respect to the other (the frequency being fixed). A typical vibrational weld joint is shown in Figure 10.2.

Figure 10.2 Typical vibrational welding joint

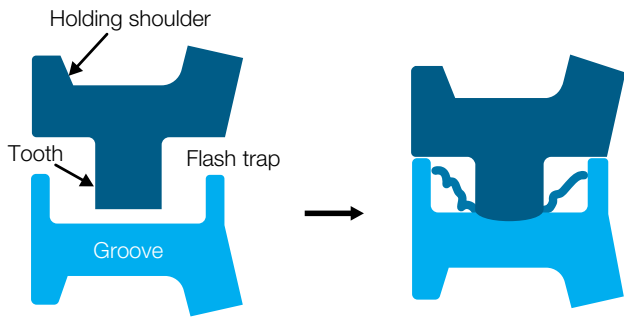

Ultrasonic welding

Ultrasonic welding is similar to vibration welding with the exception that the frequency of vibration is much higher, typically 20 to 40 kHz, and the amplitude of the vibration is much smaller, usually 60 to 100 μm. The energy is transmitted to the interface through a sonotrode or horn while the parts to be welded are firmly clamped in place and under pressure.

Some common joint designs for ultrasonic welding are shown in Figures 10.3 through 10.5. A common element is a pointed feature called the energy director.

For a semi-crystalline resin with a high melting point, such as AvaSpire® PAEK, an energy director joint design may not give optimum results. The molten material flowing from the energy director might re-solidify before fusing with the adjoining interface. If geometry permits a shear joint, as shown in Figure 10.6, it may give a stronger joint. In this design, welding is accomplished by melting the small initial contact area and then melting a controlled interference along the vertical wall as the parts are compressed.

Figure 10.3 Butt joint

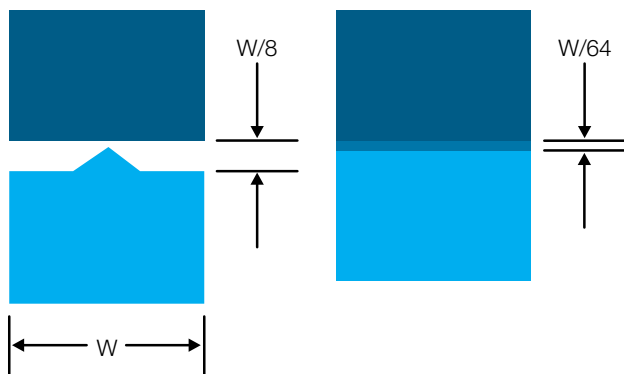

Figure 10.4 Step joint

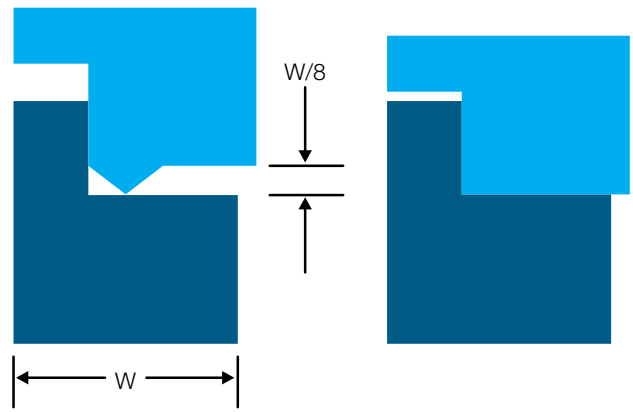

Figure 10.5 Tongue and groove joint

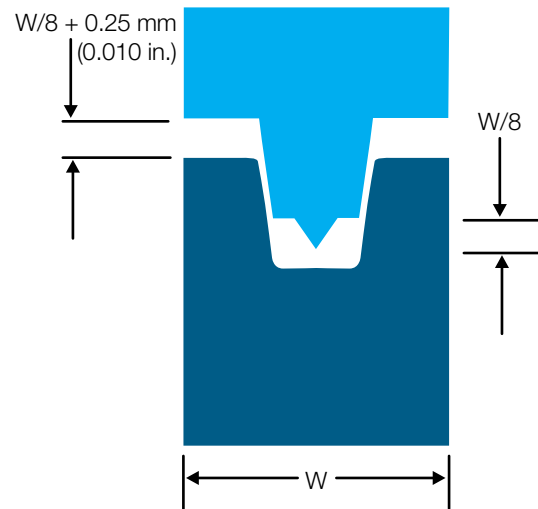
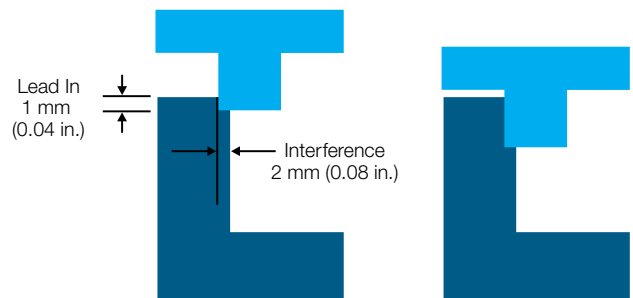

Figure 10.6 Shear joint



Laser welding

Laser welding has become a popular method of joining plastics in a wide variety of applications. This process offers a number of attractive features including:

- Speed and efficiency
- Cleanliness, no debris as with vibration or ultrasonic welding
- No consumables, such as adhesives
- No vibration that can damage sensitive components
- High bond strength
- Hermetic seal can be achieved
- Laser equipment can be used for multiple applications

Laser welding typically joins two materials that differ in their response to laser radiation. One material is essentially transparent to the laser (the transmissive material) and the other absorbs the energy and melts (the absorbing material). Welding occurs when the laser energy causes the temperature of the absorbing component to increase to its melting point. Heat is transferred to the transmitting component by conduction. When it melts, the laser energy is removed and the material cools forming a strong joint.

Figure 10.7 Laser welding process

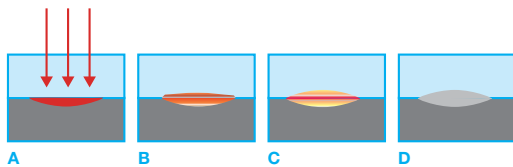

Where:

- A = Laser energy penetrates the upper layer and is absorbed by the lower material
- B = Molten material transfers heat to the upper layer
- C = A molten pool forms from both layers
- D = The pool solidifies when it cools to form a high-strength weld

The natural colored (NT) grades of AvaSpire® PAEK are laser transmissive up to 1.5 mm (1/16 inch) thick and the black (BK) grades are the absorbers.

Adhesive Bonding

AvaSpire® PAEK may be adhesively bonded to itself or other substrates using a variety of adhesives. The preferred adhesive will depend on the bond strength desired, the service temperature of the assembly and the chemical environment in which it will operate.

The bond strength achieved will depend on the type of adhesive used and the surface preparation method.

Surface preparation

The surfaces to be bonded must be clean and dry as well as free of any contamination such as grease or oil. Mold release sprays commonly used in injection molding should be avoided.

At the very least, the surfaces should be cleaned with a solvent such as isopropyl alcohol and dried completely. Additional surface treatment can significantly improve the bond strength over an untreated surface. Mechanical abrasion along with chromic acid, laser and plasma etching can improve bond strength as shown in Figure 10.8.

Figure 10.8 Surface preparation and bond strength

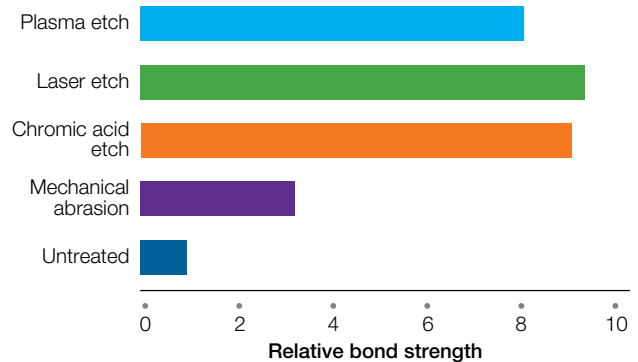

Selection of adhesive

Cyanoacrylate adhesives are usually one component systems that are easy to use and provide excellent bond strength. Their upper use temperature is limited to approximately 120 °C (250 °F), so they are not appropriate for higher temperature applications.

Epoxy-based adhesives are available that are capable of operating at temperatures up to 200 °C (392 °F). Epoxy adhesives are typically two component systems that are mixed together just before use.

Epoxy adhesives usually have lower bond strengths than cyanoacrylates. When selecting an adhesive for AvaSpire® PAEK, it is advisable to consult with an adhesive supplier, indicating the substrates that are to be bonded, the service temperature and the chemical environment.

Painting and Marking

Articles fabricated from AvaSpire® PAEK may be painted, printed or marked by methods commonly used for plastics. Painting is commonly used to impart protection from ultraviolet radiation, such as sunlight.

Adhesion is significantly improved by a surface activation such as a plasma treatment immediately prior to application.

AvaSpire® PAEK articles may also be laser marked to provide a high contrast marking. On natural-colored materials, the marking can range from a light brown to nearly black, depending on the intensity of the laser. On black articles, the marking will be gray to white.

Vacuum Metallization and Plating

Vacuum metallization involves the evaporation and condensation of a metal onto a substrate in a vacuum chamber. AvaSpire® PAEK articles may be vacuum metallized by conventional methods. Since the layer of metal deposited is extremely thin, a good surface finish (clean and free of imperfections) is necessary. Consequently, a basecoat may be used to improve the surface prior to metallization.

AvaSpire® PAEK articles may also be electroless plated by conventional methods.

Crystallinity and Annealing

AvaSpire® polyaryletherketone (PAEK) is considered a semi-crystalline polymer, which means that at equilibrium some of the polymer chains are aligned in highly oriented or crystalline regions and some of the chains are in a random or amorphous arrangement. AvaSpire® PAEK is offered in high, medium and low flow grades that vary in molecular weight. The maximum amount of crystallization and the speed of crystallization vary inversely with molecular weight.

The semi-crystalline nature of PAEK is responsible for many of its desirable properties. AvaSpire® PAEK articles that have not achieved optimum crystallinity levels may exhibit reduced mechanical properties, chemical resistance and dimensional instability on thermal exposure.

Figure 10.9 Crystalline and amorphous regions

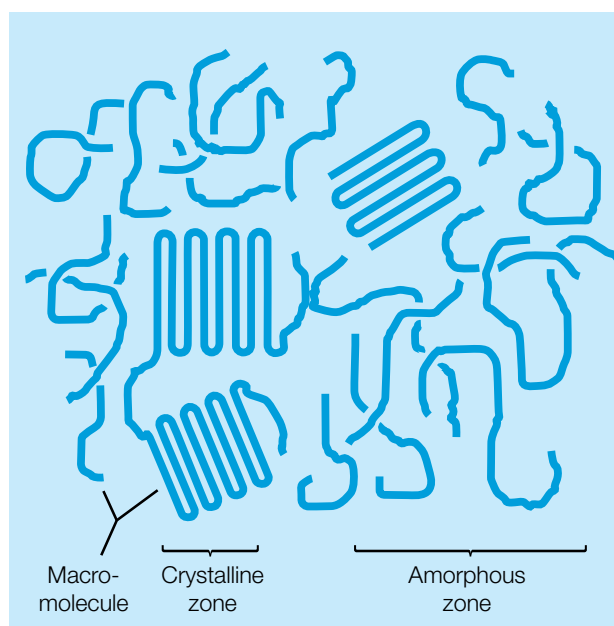

Crystalline Structure Formation

When the polymer is melt processed, it goes through a molten state, then it is forced into a mold or through an extrusion die. After that, it is cooled and the solid article or shape is achieved. In the molten state, there is essentially no well-organized crystalline structure. As the polymer cools the crystalline structure begins to form. Polymer chain mobility is required for the alignment of the polymer chains into the crystalline structure, and mobility is directly related to the temperature of the polymer.

Figure 10.10 shows that the amount of crystallinity is maximized when the cooling rate is low. For injection-molded parts, the primary factors controlling cooling rate are mold temperature and section thickness. To maximize crystallinity, it is important to cool the polymer slowly. A mold temperature of 150 °C to 180 °C (300 °F to 355 °F) is therefore recommended for the AV-600 series and 177 °C to 204 °C (350 °F to 400 °F) for the AV-700 series. If the polymer is cooled too quickly, some of the polymer may be frozen in the amorphous phase. If the molded object has variable section thickness, the thinnest section may have lower relative crystallinity than the thicker sections. Refer to the Processing Guidelines for conditions to achieve optimum crystallinity in fabricated articles.

Measurement of Crystallinity

There are several analytical methods for estimating the extent of crystallinity in a fabricated article. These methods include density measurement, differential scanning calorimetry (DSC), X-ray diffraction (XRD), infrared spectroscopy, and nuclear magnetic resonance (NMR). The measured value depends on the method used, which is therefore quoted together with the degree of crystallinity.

Figure 10.10 Cooling rate controls crystallinity

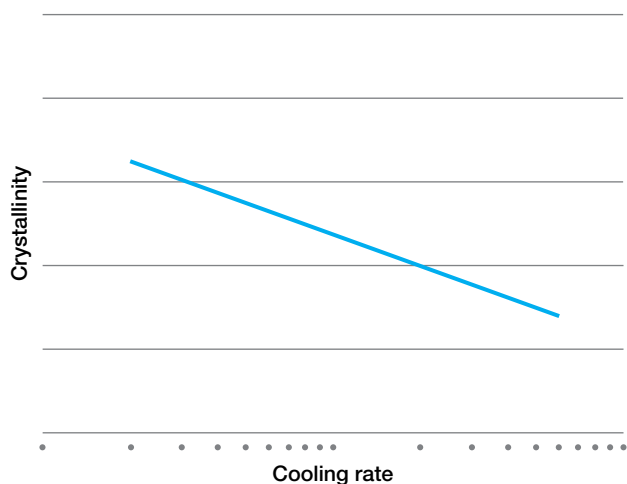

The DSC method commonly used is ASTM E793. In this test a sample of the polymer is placed in the instrument and heated while the heat flow is constantly monitored and recorded. The output from the DSC is a plot of heat flow versus temperature. The temperature is increased at a controlled, constant rate. As the temperature is increased, polymer chains can become mobile enough to align into additional crystalline regions. When this occurs, heat is released and an exothermic peak is recorded by the instrument. The instrument is calibrated to compute the area under the peak, which is expressed in Joules/g. As the temperature continues to rise, there is a second peak caused by the endothermic melting of all the crystals in the sample. The instrument also computes the area of this peak also expressed in Joules/g.

The relative crystallinity can be determined by subtracting the crystallization exotherm from the melting endotherm and dividing by the melting endotherm.

In general, 90 % of optimal crystallinity is adequate for most applications. For parts that have variable wall thickness, it is suggested that the sample for the crystallinity test be taken from the thinnest section. The thinnest section will cool fastest and is therefore more likely to have lower crystallinity.

Parts may also be visually examined. Though subjective, this examination may provide a quick indication of crystallinity. Typically, light-scattering at the crystalline interfaces results in an opaque (gray or tan) appearance. A brown appearance, especially on edges, corners, and thin sections indicates less-than-optimum crystallinity. Transparency, usually in very thin sections would also indicate that the part is amorphous.

When extruding AvaSpire® PAEK over copper wire, a pink appearance may be noted. This is not actually the color of the polymer, but the color of the copper wire seen through the transparent polymer. Thin-walled extruded tubing may exhibit a transparent appearance. Should any of these visual indicators be encountered, refer to the appropriate processing guide for parameter adjustment suggestions.

Crystallinity Affects Properties

A short study was performed to demonstrate the importance of processing for maximum crystallinity. AvaSpire® AV-621 NT was molded into tensile bars conforming to the dimensions of ASTM D638 Type 1, but with a thickness of 1.6 mm (0.0625 inch). Three mold temperatures were used: 120 °C (248 °F) which is well below the recommended temperature; 150 °C (302 °F) which is the low end of the recommended temperature range for AV-621; and 177 °C (350 °F) which is near the high end of the range. Relative crystallinity was measured by DSC, and tensile properties were measured according to ASTM D638. In addition, samples were checked using the chemical resistance under stress technique shown in “Environmental and Chemical Resistance”. Methyl Ethyl Ketone (MEK) was chosen as the reagent because it is known to be aggressive.

The samples molded with a 120 °C (248 °F) mold were about 30 % to 40 % lower in as-molded tensile strength and 25 % to 35 % lower in modulus than the samples molded with a 177 °C (350 °F) mold. Although the appearance of the samples indicated they were crystallized, DSC showed that the relative crystallinity was only about 35 %. These samples also showed crazing with MEK at critical strain levels of about 20 % of the critical strain of parts molded with a 177 °C (350 °F) mold.

Samples molded with a 150 °C (302 °F) mold were better, but still less than optimum. Crystallinity was about 60 % and the tensile strength was about 15 % low and the modulus 10 % to 15 % low compared to those molded with a 177 °C (350 °F) mold. These samples also showed crazing at about 25 % of the critical strain of the parts molded with a 177 °C (350 °F) mold.

The samples molded with the mold at 177 °C (350 °F) had the highest tensile strength and modulus and the lowest ultimate elongation. The relative crystallinity by DSC was 100 %, and they had the best chemical resistance as shown by the fact that they did not craze at the maximum strain possible with this combination of specimen thickness and parabolic curve.

Samples were then annealed for 2 hours at 200 °C (392 °F). Even the samples molded with the mold at 177 °C (350 °F), which had 100 % relative crystallinity by DSC, had property changes on annealing. Tensile strength increased by about 5 % to 10 % and tensile modulus increased about 5 % to 10 %. Ultimate elongation decreased by about 20 %. The annealed samples also had resistance to crazing. In fact, no crazing was seen at the maximum strain for this combination of specimen thickness and parabolic curve.

The bars used for this study were much thinner than the typical molded part so the changes seen are probably greater than should be expected for the typical molded part.

Annealing Fabricated Articles

In most cases, annealing articles fabricated from AvaSpire® PAEK is neither required nor desirable. In certain circumstances, a post fabrication annealing step can provide some benefits.

If the injection-molded article has low crystallinity as evidenced by appearance or DSC, annealing can increase the amount of crystallization. It is more desirable to achieve optimum crystallinity during the initial fabrication and eliminate this extra operation. Annealing may cause the modulus and strength of the material to increase slightly, but ductility may be reduced.

High residual stresses, whether the result of machining or molding, may be relieved by annealing. Occasionally warpage or distortion may occur when machining a part from either a stock shape or a near-net molded part. Annealing prior to machining may eliminate or reduce the amount of warp and/or distortion. Some Injection molded parts may also have a tendency to warp and annealing in a fixture may help.

An annealing step may also have some undesired consequences. The article may undergo dimensional changes and additional shrinkage: Since the crystalline regions are more highly ordered than the amorphous regions, they occupy less volume. This may result in some shrinkage occurring during annealing. In addition, if a part contains wall sections of varying thickness, this shrinkage may not occur uniformly, resulting in part warpage or distortion. If this occurs, the part may require fixturing during annealing to prevent distortion.

These factors should be carefully considered before a decision is made to anneal articles. If a large number of articles are to be annealed, it is advisable to first anneal just a few to insure that there are no undesirable effects.

Annealing Procedure

For most injection molded articles less than 10 mm (0.400 in.) thick an annealing exposure of 2 to 4 hours at 200 °C (392 °F) is sufficient. The articles should be placed in a preheated, air circulating oven capable of maintaining temperature uniformity of ± 5 °C (9 °F). They should be arranged in the oven so that airflow is not inhibited. If articles must be stacked, it is important to verify that airflow is maintained so that all articles will be heated uniformly and that the weight of the articles on top will not distort the articles on the bottom.

After the specified time, the oven should be turned off and the articles should be allowed to cool slowly to ambient temperature in the oven. Articles should be inspected and tested after annealing to ensure the desired result has been achieved. Articles with a larger cross section, such as extruded rods, will need to be annealed for longer periods at 200 °C (392 °F). The annealing time to achieve the desired result is usually experimentally determined.

In-line annealing, for continuous processes such as wire and cable or thin-walled tubing extrusions, may also be done. The temperature to be used is 200 °C (392 °F). The length of the annealing chamber will depend on the thickness of the stock and the extrusion line speed and may not always be practical.

Machining Guidelines

Introduction

Production of components by machining from stock shapes can be an economical alternative to injection molding when the production volume is too low to justify the cost of an injection mold. Prototype parts for proof testing prior to building an injection mold are often produced by machining. Stock shapes of AvaSpire® polyaryletherketone (PAEK) are available from several processors in a variety of grades and sizes.

Also, injection molded parts can be machined to add details not incorporated into the mold or to achieve dimensional tolerances closer than those that can be held by conventional injection molding.

General Guidelines

The information in this section is designed to provide starting points for those not familiar with the machining of high-performance polymers. These recommendations may not be the optimum conditions for all situations. In general, the tooling and techniques normally used for machining soft steels or aluminum are appropriate for use with AvaSpire® PAEK.

Tooling

Positive tool geometries with ground peripheries are recommended. Carbide tooling with polished surfaces is generally adequate for the unfilled grades and low production volumes, but it will dull fairly quickly. Diamond coated or polycrystalline tooling is recommended for the grades containing glass or carbon fibers, as well as for higher production volumes.

Coolants

Use of a coolant, either water- or oil-based, is suggested to help remove chips and thermally manage both the stock and tooling. Since these polymers have low thermal conductivity and high thermal expansion, stock overheating may occur with aggressive machining leading to dimensional issues when the part cools.

Chucking and part support

Use minimum jaw pressure to hold the stock. Excessive pressure can cause deformation. Support thin sections well to avoid deflection by the cutting tool. Also, use shallower cut depths as the part thickness decreases.

Pre-cut and finish machining

AvaSpire® PAEK shapes may be rough cut using fairly aggressive rates. Finish cuts should be done with smaller increments. When machining large holes, pilot holes will ensure that bores are centered and allow the final cut to be straight.

Fiber Orientation in Extruded Shapes

Many of the stock shapes available for machining are prepared by extrusion. When fiber-reinforced polymers are extruded, the fibers tend to become aligned in the extrusion or machine direction. The mechanical properties will be much higher in the machine direction than the properties in the transverse direction, as illustrated in Figure 1. When machining extruded stock shapes made from fiber-reinforced grades, it is important to remember the property variation due to extrusion direction. When preparing prototypes for testing prior to injection molding, this factor must be taken into account.

A molded part may show some property variation due to flow direction, but it will be much smaller than that seen in the extruded stock shape. The fiber orientation in a molded part will be much more random and the properties should fall between the flow and transverse properties of the machined part. Whenever possible, the mechanical requirements of the part should be considered

Figure 10.11 Fiber orientation affects strength

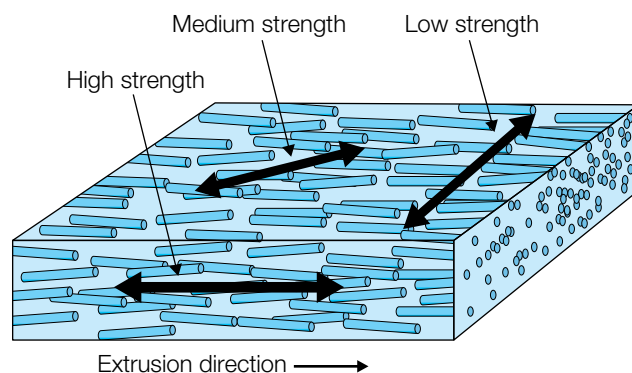

with respect to the orientation of the stock and the resultant property variation.

Stress relieving or annealing

While stock shapes are stress relieved during manufacture, machining may induce stresses that can result in dimensional instability or reduced mechanical properties. Should this be encountered, a stress relief (annealing) step may offer improved results. Since this procedure can vary greatly by grade and geometry, consult your Solvay technical representative for specific details.

Machining Parameters

Drilling

AvaSpire® PAEK is a thermal insulator and this must be considered when drilling.

Small Diameter Holes – Under 25 mm (1 inch)

Use high-speed twist drills with frequent pull-out to aid swarf removal.

Large diameter holes

Use a slow spiral drill. It is suggested that a pilot hole with a maximum diameter of 12 mm (0.5 inch) be drilled. Starting point drilling parameters are shown in Table 10.1.

Table 10.1 Drilling parameters

Hole Diameter mm (inch)	Feed rates mm/rev (inch/rev)
1 – 6 (1/16 – 1/4)	0.05 – 0.13 (0.002 – 0.005)
6 – 25 (1/4 – 1)	0.10 – 0.20 (0.004 – 0.008)
> 25 (1)	0.20 – 0.30 (0.008 – 0.012)

Turning

Turning speeds and feeds will differ for unreinforced and reinforced grades. The recommended starting points are shown in Table 10.2.

Table 10.2 Turning parameters

Material	Speed m/min (ft/min)	Feed mm/rev (inch/rev)
Unfilled	150 – 275 (500 – 900)	0.25 – 0.38 (0.010 – 0.015)
Reinforced	150 – 215 (500 – 700)	0.10 – 0.18 (0.004 – 0.007)

Sawing

Recommendations for sawing are shown in Table 10.3.

Table 10.3 Sawing parameters

Stock Thickness mm (inch)	Pitch teeth/inch	Band Speed m/min (ft/min)
12 – 25 (1/2 – 1)	6 – 8	1,070 (3,500)
25 – 76 (1 – 3)	3	900 (3,000)
> 76 (3)	3	760 (2,500)

Milling

Climb milling is recommended over conventional milling as shown in Figure 10.12. End milling suggested starting points are shown in Table 10.4, and face milling in Table 10.5.

Figure 10.12 Climb milling recommended

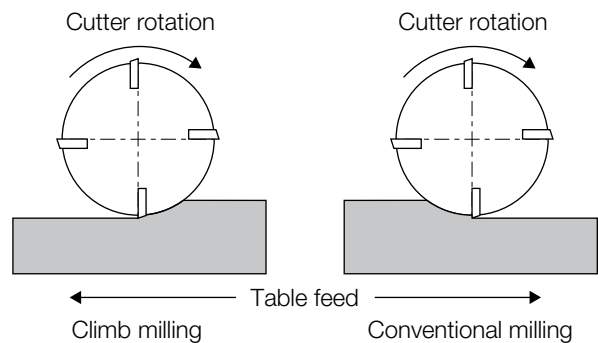

Table 10.4 End milling and slotting

Diameter mm (inch)	Depth of Cut mm (inch)	Speed m/min (ft/min)	Feed mm/tooth (inch/tooth)
6 (1/4)	6 (0.250)	80 – 135 (270 – 450)	0.05 (0.002)
12 (1/2)	6 (0.250)	80 – 135 (270 – 450)	0.08 (0.003)
18 (3/4)	6 (0.250)	80 – 135 (270 – 450)	0.13 (0.005)
25 (1)	6 (0.250)	80 – 135 (270 – 450)	0.20 (0.008)
6 (1/4)	1.3 (0.050)	90 – 150 (300 – 500)	0.02 (0.001)
12 (1/2)	1.3 (0.050)	90 – 150 (300 – 500)	0.05 (0.002)
18 (3/4)	1.3 (0.050)	90 – 150 (300 – 500)	0.10 (0.004)

Table 10.5 Face milling

Depth of Cut mm (inch)	Speed m/min (ft/min)	Feed mm/tooth (inch/tooth)
3.0 (0.150)	150 – 215 (500 – 700)	0.50 (0.020)
1.5 (0.060)	150 – 215 (500 – 700)	0.13 (0.005)

Troubleshooting

Suggestions for troubleshooting are shown in Table 10.6.
Contact your Solvay representative for additional assistance.

Table 10.6 Troubleshooting machining operations

Problem	Possible Cause
Drilling	
Hole tapered	Drill not sharpened properly Not enough clearance
Melted surface	Wrong kind of drill Feed too slow Dull drill
Chipping	Feed too fast Too much clearance Too much rake
Turning	
Melted surface	Dull tool Not enough side clearance Feed too slow Spindle too fast
Rough finish	Feed too fast Not enough nose radius on tool Wrong clearance angle
Cracking or chipping	Positive rake on tool too high Abrupt cutting Dull tool
Chatter	Too much nose radius Tool not mounted tightly Material not supported well enough Cut depth too high

A		D	
Adhesive Bonding	115	Deflection Calculations	78
Agency Approvals.	16	Deflection Temperature Under Load (HDT)	43
Aircraft Fluids	62	Design Considerations	38
Annealing	102	Design Implications	42
Annealing Fabricated Articles	118	Designing for Equivalent Part Stiffness	80
Annealing Procedure	118	Designing for Injection Molding	88
Apparent or Creep Modulus Graphs	35	Designing for Sustained Load	81
Assembly, Designing for.	83	Designing with Snap Fits	86
ASTM International	16	Design Principles	74
Automotive Fluids	63	Dielectric Breakdown Voltage and Strength	56
AV-600 Series.	5	Dielectric Constant	57
AV-700 Series.	5	Dissipation Factor.	57
AV-800 Series.	6	Draft	98
AvaSpire® PAEK Grades	6	Draft Angle	88
B		E	
Bosses	89	Effect of Temperature	27
C		Electrical Properties.	56
Calculating the Allowable Interference.	83	Electron Beam	69
Cavity Layout	95	Environmental and Chemical Resistance	60
Chemical Resistance	60	Equipment for Extrusion	104
CLTE Definition	40	Equipment for Injection Molding.	94
CLTE Measurement.	40	Equipment for Wire and Cable Extrusion	110
CLTE Results	42	Ethylene Oxide	69
Combustion Properties	51	Extrusion	104
Commercial Aircraft Tests.	53	Extrusion Materials	104
Comparative Tracking Index (CTI) – ASTM D3638	58	F	
Comparing CLTE Values from Different Sources.	43	Falling Weight Impact Tests	32
Compressive Modulus Testing	29	Fatigue Properties	38
Compressive Properties.	28	Fatigue Testing	38
Compressive Strength Testing	28	Fiber Orientation in Extruded Shapes	119
Computer Aided Engineering (CAE).	82	Fibrous Reinforcement	19
Considering Stress Concentrations	81	Filament.	107
Coring	89	Fine Fiber	107
Coupling the Injection Molding and Mechanical Simulations	83	Finite Element Analysis (FEA)	82
Creep.	34	Flexural Properties	26
Creep Properties	34	Food Contact.	16
Crystalline Structure Formation	116	G	
Crystallinity Affects Properties.	117	Gamma Radiation.	69
Crystallinity and Annealing	116	Gating	97
		General Machining Guidelines.	119
		Glass Transition Temperature (T _g).	44
		Glow Wire Testing.	51

H		R	
Heat Aging	46	Regrind	102
High-Current Arc Ignition (HAI)	59	Reinforcing Fiber Orientation Considerations	79
High-voltage arc resistance to ignition	59	Rheological Properties	90
High-Voltage Arc Tracking Rate (HVTR)	58	Ribs.	88
High-voltage, low-current, dry arc resistance – ASTM D495	58	S	
Hot Wire Ignition (HWI) - ASTM D3874	58	Secondary Operations	113
I		Shear Properties	30
Immersion Testing.	60	Shear Strength Test Method	30
Impact Properties	31	Shear Strength Values	30
Injection Molding	94	Sheet and Film Extrusion	105
Injection Molding Process.	99	Short-Term Mechanical Properties	17
Injection Molding Simulation	82	Specific Heat	45
Instrumented Impact Testing	33	Starting Point Molding Conditions.	101
Interference or Press Fits	83	Starting Point Process Conditions.	105
Introduction and Typical Properties	5	Start-Up, Shut-Down and Purging	102
Introduction to Machining Guidelines	119	Steam Autoclaving	70
ISO 10993	16	Sterilization Resistance	69
J		Stress Calculations	78
Joining	113	Stress Testing.	60
L		Surface Resistivity	57
Limitations of Design Calculations.	78	T	
Linear Thermal Expansion.	40	Tapered Cantilever Beam Equation	87
Long-Term Mechanical Properties	34	Temperature	19
Low-Temperature Hydrogen Peroxide Sterilization	70	Temperature Effects.	40
M		Tensile Properties	17
Machining Guidelines	119	Testing AvaSpire® PAEK	39
Machining Parameters	120	Test Methods	26
Measurement of Crystallinity	117	Test Methods for Flexural Properties	26
Mechanical Design	75	Thermal Conductivity	45
Mechanical Fasteners.	84	Thermal Management.	99
Melting Temperature (Tm).	44	Thermal Properties	40
Mold Shrinkage	96	Thermal Stability	46
N		Thermogravimetric Analysis (TGA)	49
Notched Izod	31	Tooling	95
O		Transportation Fluid Resistance	62
Oil and Gas Fluids Resistance	65	Troubleshooting.	121
Oxygen Index	53	Tube Extrusion	106
P		U	
Painting and Marking	116	UL 746A Short-Term Properties.	58
Poisson's Ratio	17	Underwriters Laboratories	16
Processing	90, 111	Unnotched Izod.	32
Process Setup	100	Using Classical Stress-Strain Equations.	75
Profile Extrusion.	106	V	
Property Data	6	Vacuum Metallization and Plating	116
R		Vertical Flammability per UL 94	51
S		Volume Resistivity.	56
T		W	
U		Wall Thickness Variation.	88
V		Water Absorption	73
W		Weathering	71
X		Welding.	113
Y		Wire and Cable Extrusion	110



Specialty Polymers

Worldwide Headquarters

SpecialtyPolymers.EMEA@solvay.com

Viale Lombardia, 20
20021 Bollate (MI), Italy

Americas Headquarters

SpecialtyPolymers.Americas@solvay.com

4500 McGinnis Ferry Road
Alpharetta, GA 30005, USA

Asia Headquarters

SpecialtyPolymers.Asia@solvay.com

No.3966 Jindu Road
Shanghai, China 201108

www.solvay.com

Safety Data Sheets (SDS) are available by emailing us or contacting your sales representative. Always consult the appropriate SDS before using any of our products.

Neither Solvay Specialty Polymers nor any of its affiliates makes any warranty, express or implied, including merchantability or fitness for use, or accepts any liability in connection with this product, related information or its use. Some applications of which Solvay's products may be proposed to be used are regulated or restricted by applicable laws and regulations or by national or international standards and in some cases by Solvay's recommendation, including applications of food/feed, water treatment, medical, pharmaceuticals, and personal care. Only products designated as part of the Solviva® family of biomaterials may be considered as candidates for use in implantable medical devices. The user alone must finally determine suitability of any information or products for any contemplated use in compliance with applicable law, the manner of use and whether any patents are infringed. The information and the products are for use by technically skilled persons at their own discretion and risk and does not relate to the use of this product in combination with any other substance or any other process. This is not a license under any patent or other proprietary right.

All trademarks and registered trademarks are property of the companies that comprise the Solvay Group or their respective owners.
© 2014, Solvay Specialty Polymers. All rights reserved. D 01/2014 | Version 1.1